

Micropower, 200 mA Ultra Low-Dropout Fixed or Adjustable Voltage Regulator

Check for Samples: [LP2986](#)

FEATURES

- Ultra Low Dropout Voltage
- Ensured 200 mA Output Current
- SOIC-8 and VSSOP-8 Surface Mount Packages
- <math><1\ \mu\text{A}</math> Quiescent Current when Shutdown
- Low Ground Pin Current at All Loads
- 0.5% Output Voltage Accuracy ("A" Grade)
- High Peak Current Capability (400 mA Typical)
- Wide Supply Voltage Range (16V Max)
- Overtemperature/Overcurrent Protection
- -40°C to $+125^{\circ}\text{C}$ Junction Temperature Range

APPLICATIONS

- Cellular Phone
- Palmtop/Laptop Computer
- Camcorder, Personal Stereo, Camera

DESCRIPTION

The LP2986 is a 200 mA precision LDO voltage regulator which offers the designer a higher performance version of the industry standard LP2951.

Using an optimized VIP™ (Vertically Integrated PNP) process, the LP2986 delivers superior performance:

Dropout Voltage: Typically 180 mV @ 200 mA load, and 1 mV @ 1 mA load.

Ground Pin Current: Typically 1 mA @ 200 mA load, and 200 μA @ 10 mA load.

Sleep Mode: The LP2986 draws less than 1 μA quiescent current when shutdown pin is pulled low.

Error Flag: The built-in error flag goes low when the output drops approximately 5% below nominal.

Precision Output: The standard product versions available can be pin-strapped (using the internal resistive divider) to provide output voltages of 5.0V, 3.3V, or 3.0V with ensured accuracy of 0.5% ("A" grade) and 1% (standard grade) at room temperature.

Block Diagram

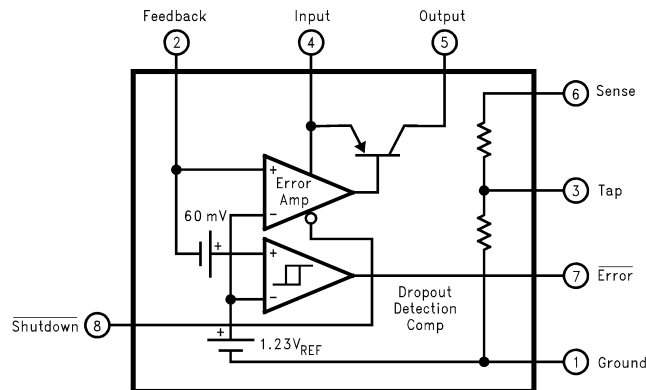

Please be aware that an important notice concerning availability, standard warranty, and use in critical applications of Texas Instruments semiconductor products and disclaimers thereto appears at the end of this data sheet.

VIP is a trademark of Texas Instruments.

All other trademarks are the property of their respective owners.

Connection Diagram

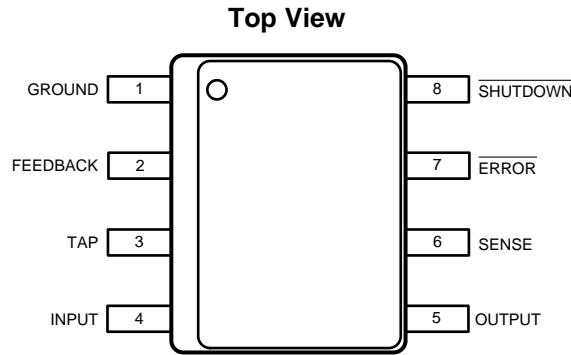

Figure 1. 8-Lead SOIC Package
See Package Number D0008A

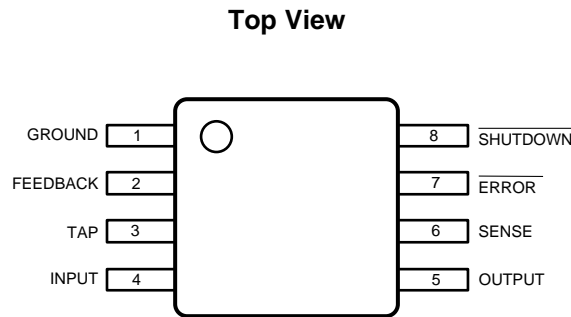

Figure 2. 8-Lead VSSOP Package
See Package Number DGK0008A

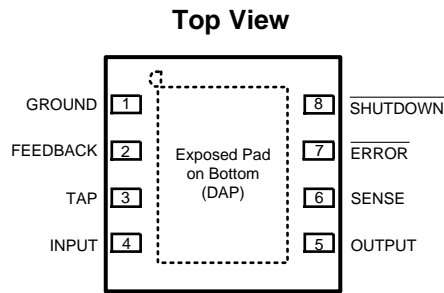

Figure 3. 8-Lead WSON Package
See Package Number NGN0008A
See [WSON MOUNTING](#) section



These devices have limited built-in ESD protection. The leads should be shorted together or the device placed in conductive foam during storage or handling to prevent electrostatic damage to the MOS gates.

Absolute Maximum Ratings⁽¹⁾⁽²⁾

Storage Temperature Range	-65°C to +150°C
Operating Junction Temperature Range	-40°C to +125°C
Lead Temperature (Soldering, 5 seconds)	260°C
ESD Rating ⁽³⁾	2 kV
Power Dissipation ⁽⁴⁾	Internally Limited
Input Supply Voltage (Survival)	-0.3V to +16V
Input Supply Voltage (Operating)	2.1V to +16V
Shutdown Pin	-0.3V to +16V
Feedback Pin	-0.3V to +5V
Output Voltage (Survival) ⁽⁵⁾	-0.3V to +16V
I _{OUT} (Survival)	Short Circuit Protected
Input-Output Voltage (Survival) ⁽⁶⁾	-0.3V to +16V

- (1) Absolute Maximum Ratings indicate limits beyond which damage to the component may occur. Electrical specifications do not apply when operating the device outside of its rated operating conditions.
- (2) If Military/Aerospace specified devices are required, please contact the Texas Instruments Sales Office/Distributors for availability and specifications.
- (3) The ESD rating of the Feedback pin is 500V. The ESD rating of the V_{IN} pin is 1kV and the Tap pin is 1.5 kV.
- (4) The maximum allowable power dissipation is a function of the maximum junction temperature, T_J(MAX), the junction-to-ambient thermal resistance, θ_{J-A} , and the ambient temperature, T_A. The maximum allowable power dissipation at any ambient temperature is calculated using:

$$P_{(MAX)} = \frac{T_{J(MAX)} - T_A}{\theta_{J-A}}$$
 The value of θ_{J-A} for the SOIC-8 package is 160°C/W, and the VSSOP-8 package is 200°C/W. The value θ_{J-A} for the WSON package is specifically dependent on PCB trace area, trace material, and the number of layers and thermal vias. For improved thermal resistance and power dissipation for the WSON package, refer to Application Note [AN-1187](#). Exceeding the maximum allowable power dissipation will cause excessive die temperature, and the regulator will go into thermal shutdown.
- (5) If used in a dual-supply system where the regulator load is returned to a negative supply, the LM2986 output must be diode-clamped to ground.
- (6) The output PNP structure contains a diode between the V_{IN} and V_{OUT} terminals that is normally reverse-biased. Forcing the output above the input will turn on this diode and may induce a latch-up mode which can damage the part (see [Application Hints](#)).

Electrical Characteristics

Limits in standard typeface are for $T_J = 25^\circ\text{C}$, and limits in **boldface type** apply over the full operating temperature range. Unless otherwise specified: $V_{IN} = V_O(\text{NOM}) + 1\text{V}$, $I_L = 1\text{ mA}$, $C_{OUT} = 4.7\text{ }\mu\text{F}$, $C_{IN} = 2.2\text{ }\mu\text{F}$, $V_{S/D} = 2\text{V}$.

Symbol	Parameter	Conditions	Typical	LM2986AI-X.X ⁽¹⁾		LM2986I-X.X ⁽¹⁾		Units
				Min	Max	Min	Max	
V_O	Output Voltage (5.0V Versions)	$0.1\text{ mA} < I_L < 200\text{ mA}$	5.0	4.975	5.025	4.950	5.050	V
			5.0	4.960	5.040	4.920	5.080	
			4.910	5.090	4.860	5.140		
	Output Voltage (3.3V Versions)	$0.1\text{ mA} < I_L < 200\text{ mA}$	3.3	3.283	3.317	3.267	3.333	
			3.3	3.274	3.326	3.247	3.353	
			3.241	3.359	3.208	3.392		
	Output Voltage (3.0V Versions)	$0.1\text{ mA} < I_L < 200\text{ mA}$	3.0	2.985	3.015	2.970	3.030	
			3.0	2.976	3.024	2.952	3.048	
			2.946	3.054	2.916	3.084		
$\frac{V_O}{\Delta V_{IN}}$	Output Voltage Line Regulation	$V_O(\text{NOM}) + 1\text{V} \leq V_{IN} \leq 16\text{V}$	0.007		0.014		0.014	%/V
$V_{IN}-V_O$	Dropout Voltage ⁽²⁾	$I_L = 100\text{ }\mu\text{A}$	1		2.0		2.0	mV
		$I_L = 75\text{ mA}$	90		120		120	
		$I_L = 200\text{ mA}$	180		230		230	
					350		350	
I_{GND}	Ground Pin Current	$I_L = 100\text{ }\mu\text{A}$	100		120		120	μA
		$I_L = 75\text{ mA}$	500		800		800	
		$I_L = 200\text{ mA}$	1		2.1		2.1	mA
		$V_{S/D} < 0.3\text{V}$	0.05		1.5		1.5	
$I_O(\text{PK})$	Peak Output Current	$V_{OUT} \geq V_O(\text{NOM}) - 5\%$	400	250		250		mA
$I_O(\text{MAX})$	Short Circuit Current	$R_L = 0$ (Steady State) ⁽³⁾	400					
e_n	Output Noise Voltage (RMS)	$\text{BW} = 300\text{ Hz to } 50\text{ kHz}$, $C_{OUT} = 10\text{ }\mu\text{F}$	160					$\mu\text{V}(\text{RMS})$
$\frac{\Delta V_{OUT}}{\Delta V_{IN}}$	Ripple Rejection	$f = 1\text{ kHz}$, $C_{OUT} = 10\text{ }\mu\text{F}$	65					dB
$\frac{\Delta V_{OUT}}{\Delta T}$	Output Voltage Temperature Coefficient	See ⁽⁴⁾	20					ppm/ $^\circ\text{C}$

- (1) Limits are 100% production tested at 25°C . Limits over the operating temperature range are ensured through correlation using Statistical Quality Control (SQC) methods. The limits are used to calculate Average Outgoing Quality Level (AOQL).
- (2) Dropout voltage is defined as the input to output differential at which the output voltage drops 100 mV below the value measured with a 1V differential.
- (3) See [Typical Performance Characteristics](#) curves.
- (4) Temperature coefficient is defined as the maximum (worst-case) change divided by the total temperature range.

Electrical Characteristics (continued)

Limits in standard typeface are for $T_J = 25^\circ\text{C}$, and limits in **boldface type** apply over the full operating temperature range. Unless otherwise specified: $V_{IN} = V_O(\text{NOM}) + 1\text{V}$, $I_L = 1\text{ mA}$, $C_{OUT} = 4.7\ \mu\text{F}$, $C_{IN} = 2.2\ \mu\text{F}$, $V_{S/D} = 2\text{V}$.

Symbol	Parameter	Conditions	Typical	LM2986AI-X.X ⁽¹⁾		LM2986I-X.X ⁽¹⁾		Units
				Min	Max	Min	Max	
FEEDBACK PIN								
V_{FB}	Feedback Pin Voltage		1.23	1.21	1.25	1.20	1.26	V
		See ⁽⁵⁾	1.23	1.20	1.26	1.19	1.27	
$\frac{\Delta V_{FB}}{\Delta T}$	FB Pin Voltage Temperature Coefficient	See ⁽⁶⁾	20					ppm/°C
I_{FB}	Feedback Pin Bias Current	$I_L = 200\text{ mA}$	150		330		330	nA
					760		760	
$\frac{I_{FB}}{\Delta T}$	FB Pin Bias Current Temperature Coefficient	See ⁽⁶⁾	0.1					nA/°C
SHUTDOWN INPUT								
$V_{S/D}$	S/D Input Voltage ⁽⁷⁾	$V_H = \text{O/P ON}$	1.4	1.6		1.6		V
		$V_L = \text{O/P OFF}$	0.55		0.18		0.18	
$I_{S/D}$	S/D Input Current	$V_{S/D} = 0$	0		-1		-1	μA
		$V_{S/D} = 5\text{V}$	5		15		15	
ERROR COMPARATOR								
I_{OH}	Output "HIGH" Leakage	$V_{OH} = 16\text{V}$	0.01		1		1	μA
					2		2	
V_{OL}	Output "LOW" Voltage	$V_{IN} = V_O(\text{NOM}) - 0.5\text{V}$, $I_O(\text{COMP}) = 300\ \mu\text{A}$	150		220		220	mV
					350		350	
$V_{THR}(\text{MAX})$	Upper Threshold Voltage		-4.6	-5.5	-3.5	-5.5	-3.5	% V_{OUT}
				-7.7	-2.5	-7.7	-2.5	
$V_{THR}(\text{MIN})$	Lower Threshold Voltage		-6.6	-8.9	-4.9	-8.9	-4.9	
				-13.0	-3.3	-13.0	-3.3	
HYST	Hysteresis		2.0					

(5) $V_{FB} \leq V_{OUT} \leq (V_{IN} - 1)$, $2.5\text{V} \leq V_{IN} \leq 16\text{V}$, $100\ \mu\text{A} \leq I_L \leq 200\ \text{mA}$, $T_J \leq 125^\circ\text{C}$.

(6) Temperature coefficient is defined as the maximum (worst-case) change divided by the total temperature range.

(7) To prevent mis-operation, the Shutdown input must be driven by a signal that swings above V_H and below V_L with a slew rate not less than $40\ \text{mV}/\mu\text{s}$ (see [Application Hints](#)).

Typical Performance Characteristics

Unless otherwise specified: $T_A = 25^\circ\text{C}$, $C_{OUT} = 4.7 \mu\text{F}$, $C_{IN} = 2.2 \mu\text{F}$, S/D is tied to V_{IN} , $V_{IN} = V_O(\text{NOM}) + 1\text{V}$, $I_L = 1 \text{mA}$.

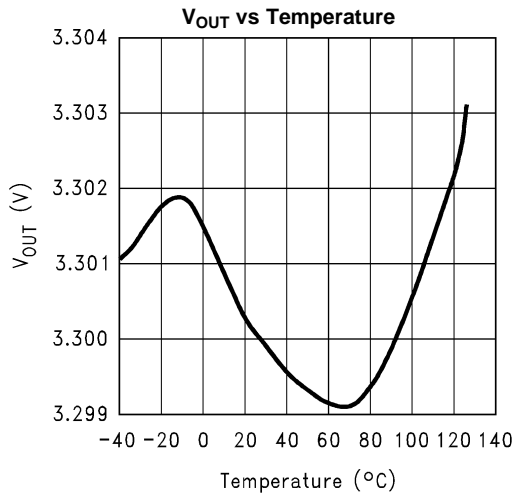

Figure 4.

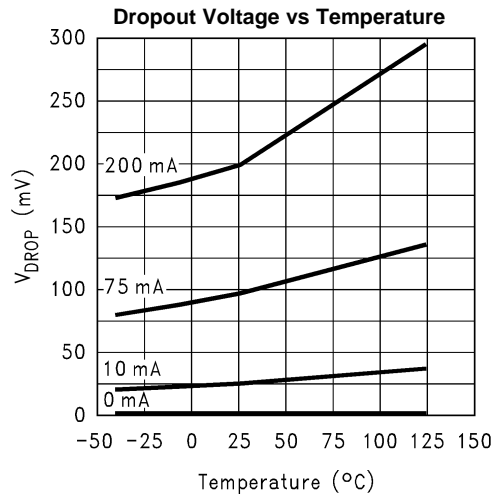

Figure 5.

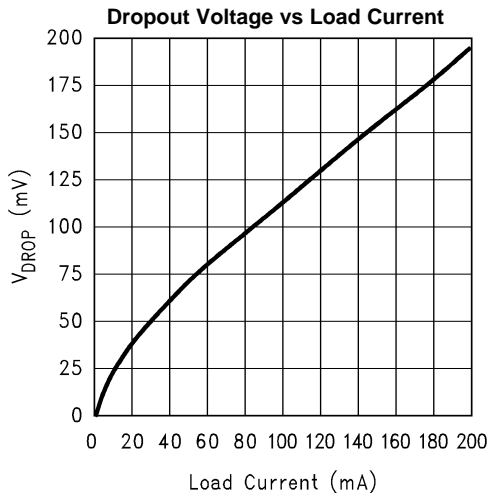

Figure 6.

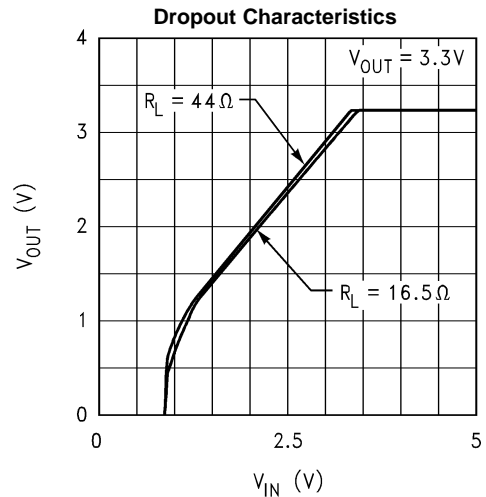

Figure 7.

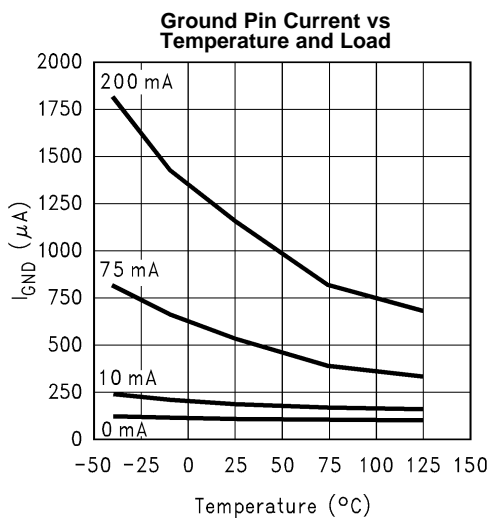

Figure 8.

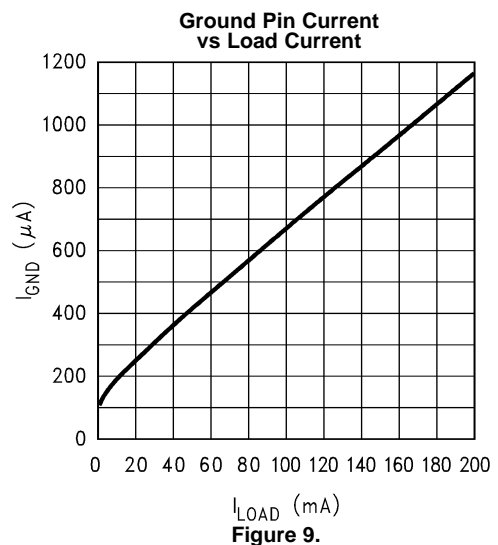

Figure 9.

Typical Performance Characteristics (continued)

Unless otherwise specified: $T_A = 25^\circ\text{C}$, $C_{OUT} = 4.7 \mu\text{F}$, $C_{IN} = 2.2 \mu\text{F}$, S/D is tied to V_{IN} , $V_{IN} = V_O(\text{NOM}) + 1\text{V}$, $I_L = 1 \text{ mA}$.

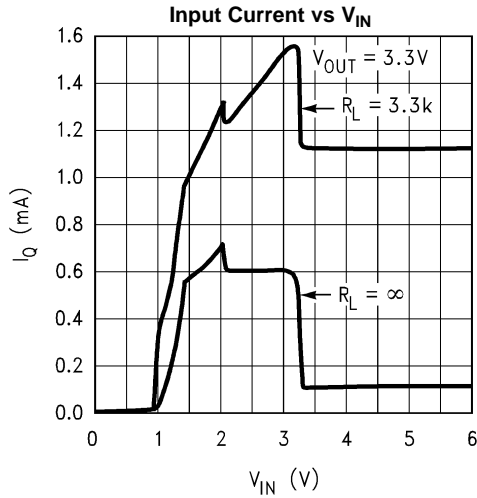

Figure 10.

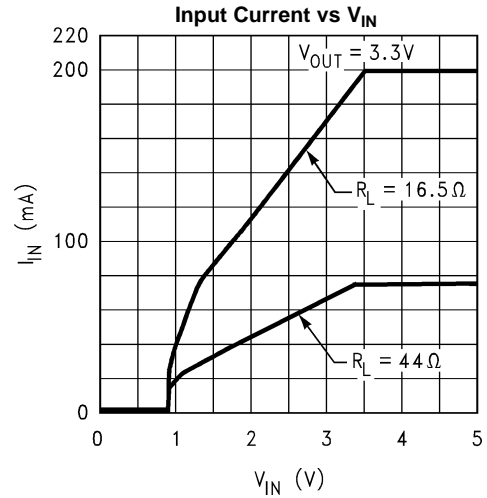

Figure 11.

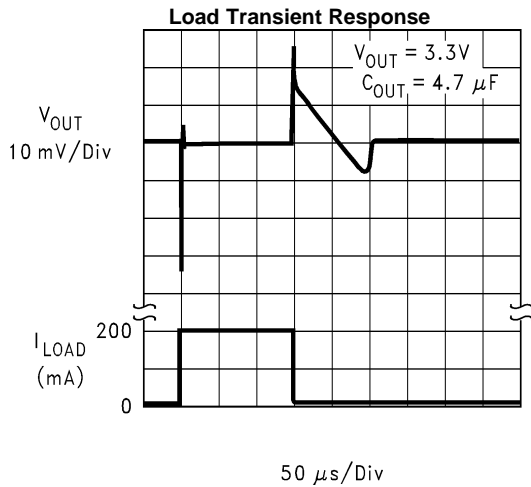

Figure 12.

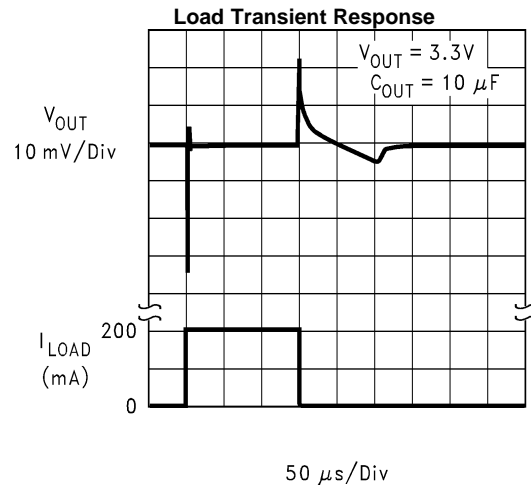

Figure 13.

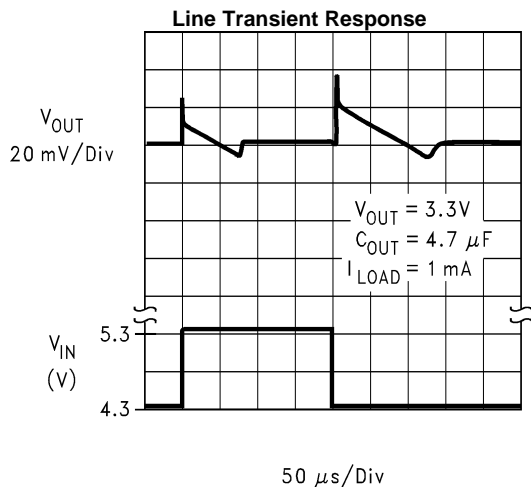

Figure 14.

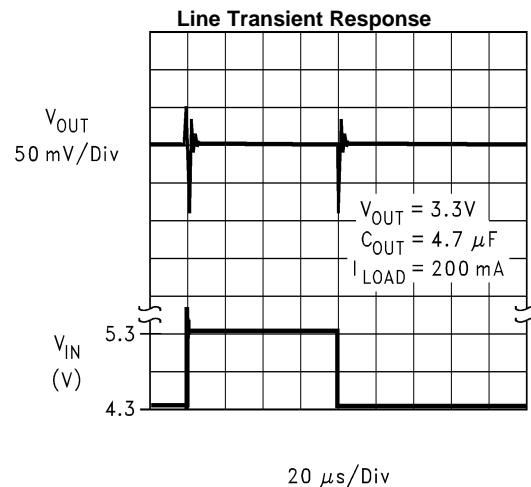
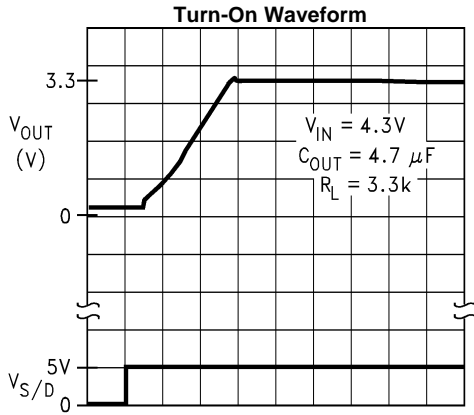

Figure 15.

Typical Performance Characteristics (continued)

Unless otherwise specified: $T_A = 25^\circ\text{C}$, $C_{OUT} = 4.7 \mu\text{F}$, $C_{IN} = 2.2 \mu\text{F}$, S/D is tied to V_{IN} , $V_{IN} = V_{O(NOM)} + 1\text{V}$, $I_L = 1 \text{ mA}$.



20 $\mu\text{s}/\text{Div}$
Figure 16.

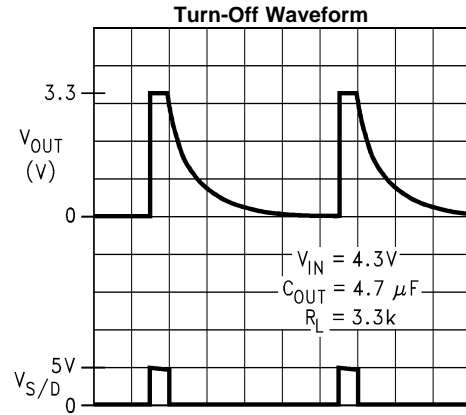

20 ms/Div
Figure 17.

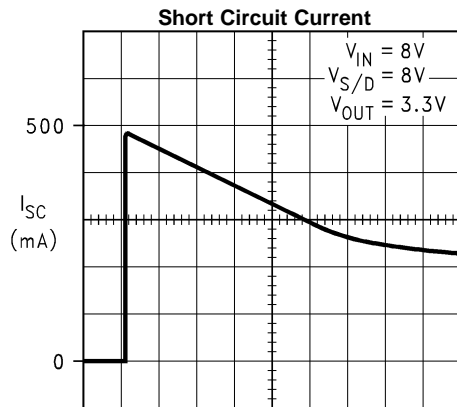

500 ms/Div
Figure 18.

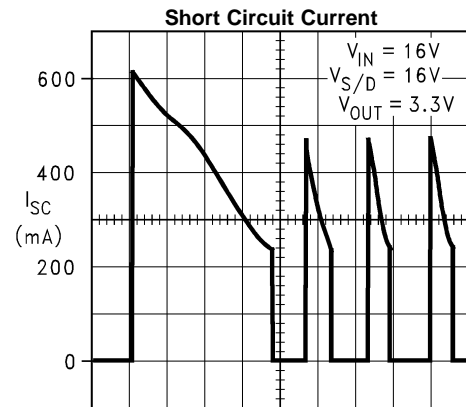

200 ms/Div
Figure 19.

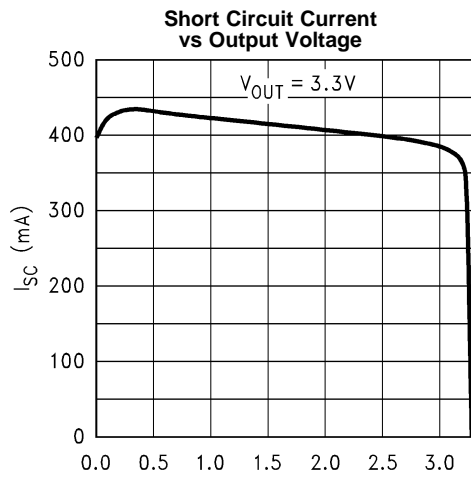

Figure 20.

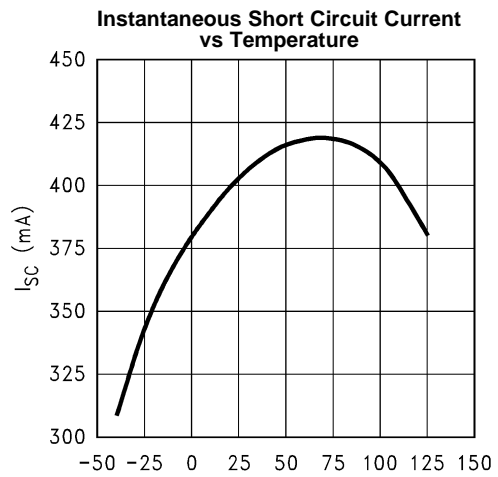
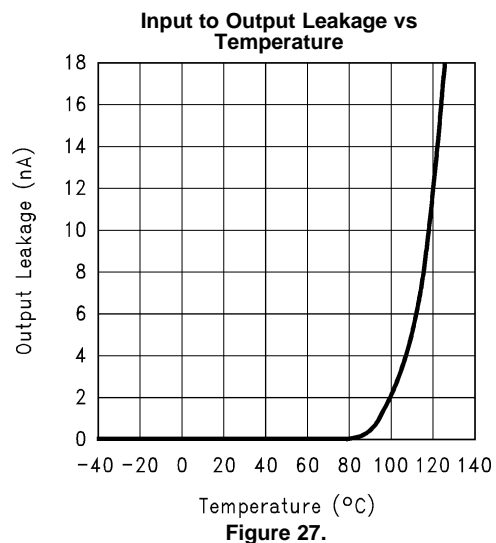
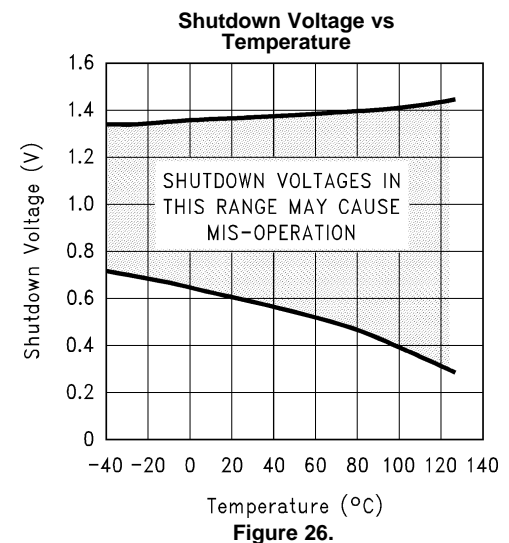
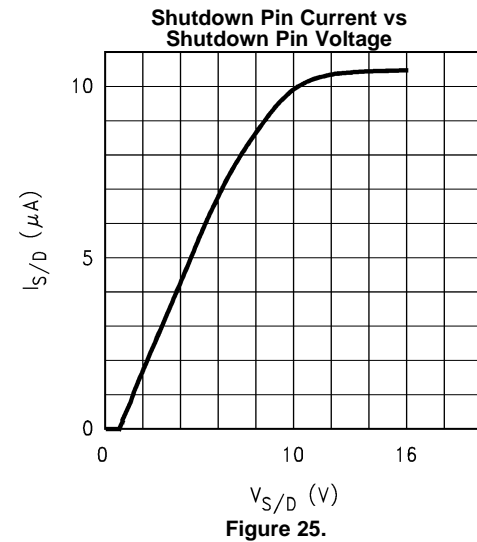
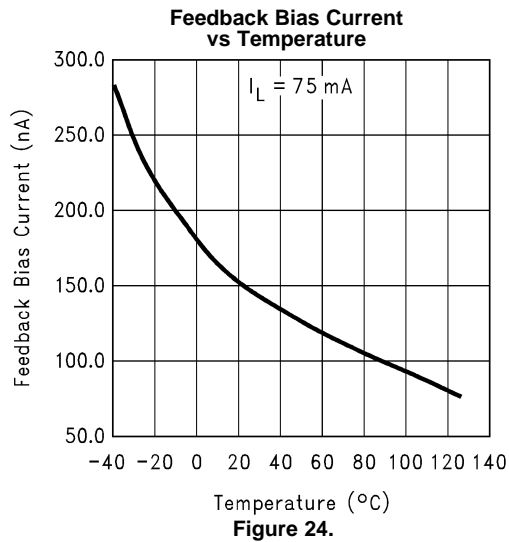
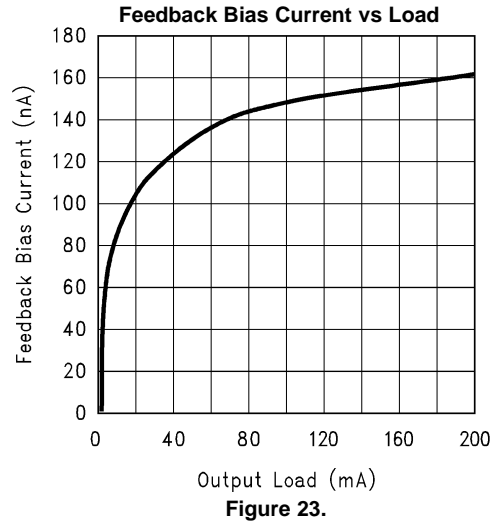
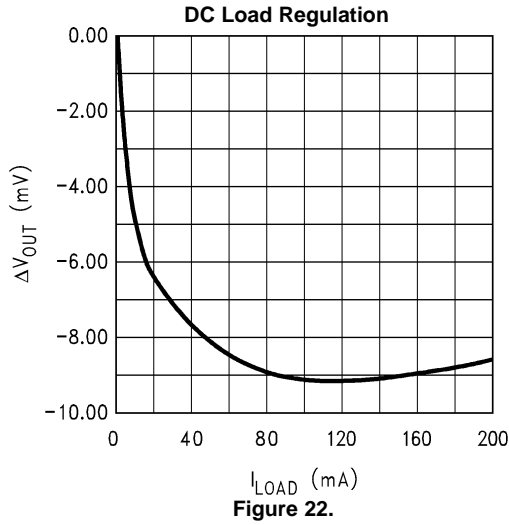

Figure 21.

Typical Performance Characteristics (continued)

Unless otherwise specified: $T_A = 25^\circ\text{C}$, $C_{OUT} = 4.7 \mu\text{F}$, $C_{IN} = 2.2 \mu\text{F}$, S/D is tied to V_{IN} , $V_{IN} = V_O(\text{NOM}) + 1\text{V}$, $I_L = 1 \text{ mA}$.



Typical Performance Characteristics (continued)

Unless otherwise specified: $T_A = 25^\circ\text{C}$, $C_{OUT} = 4.7 \mu\text{F}$, $C_{IN} = 2.2 \mu\text{F}$, S/D is tied to V_{IN} , $V_{IN} = V_O(\text{NOM}) + 1\text{V}$, $I_L = 1 \text{ mA}$.

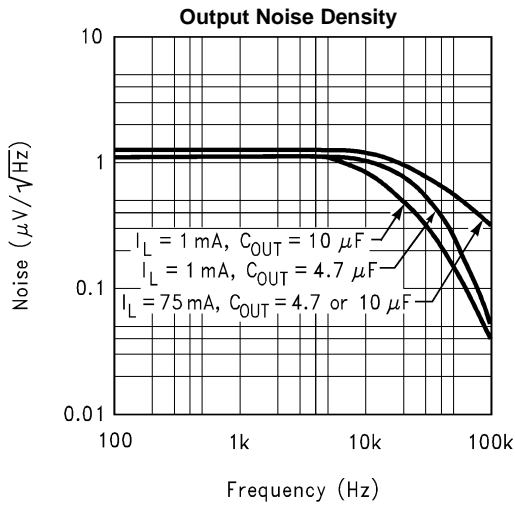

Figure 28.

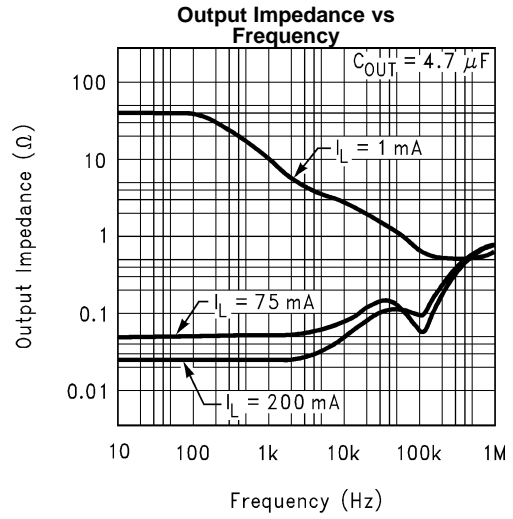

Figure 29.

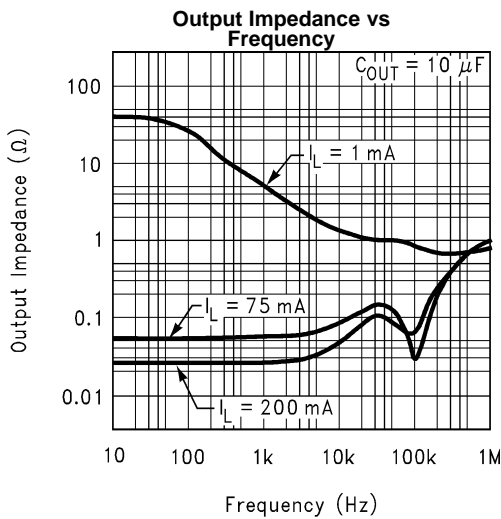

Figure 30.

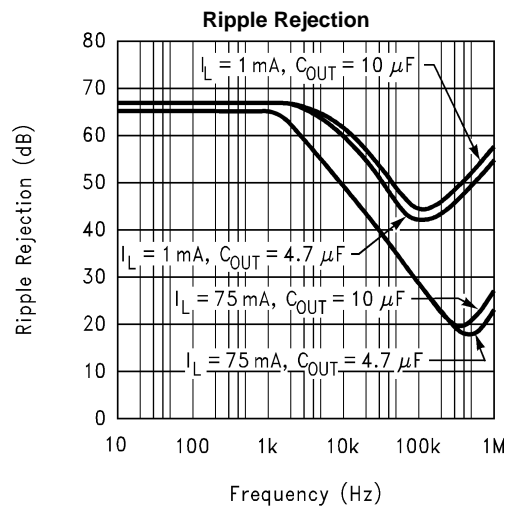
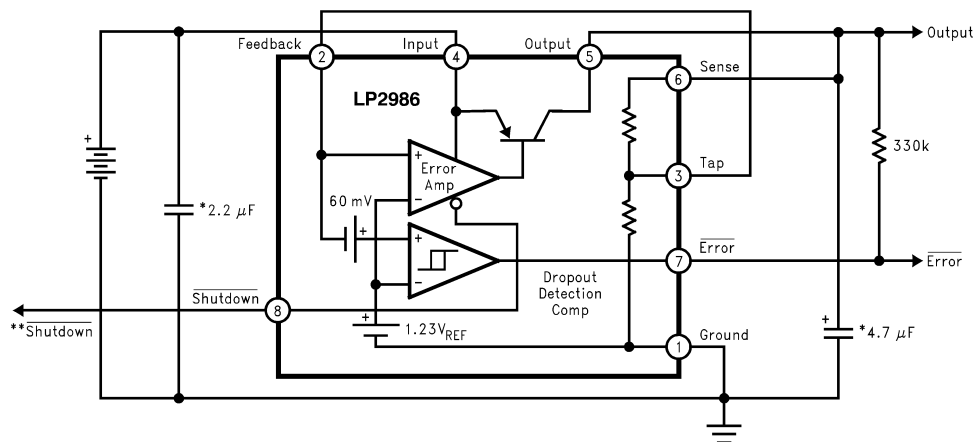

Figure 31.

Basic Application Circuits



* Minimum capacitance shown to assure stability, but may be increased without limit. Larger output capacitor provides improved dynamic response.

** Shutdown input must be actively terminated. Tie to V_{IN} if not used.

Figure 32. Application Using Internal Resistive Divider

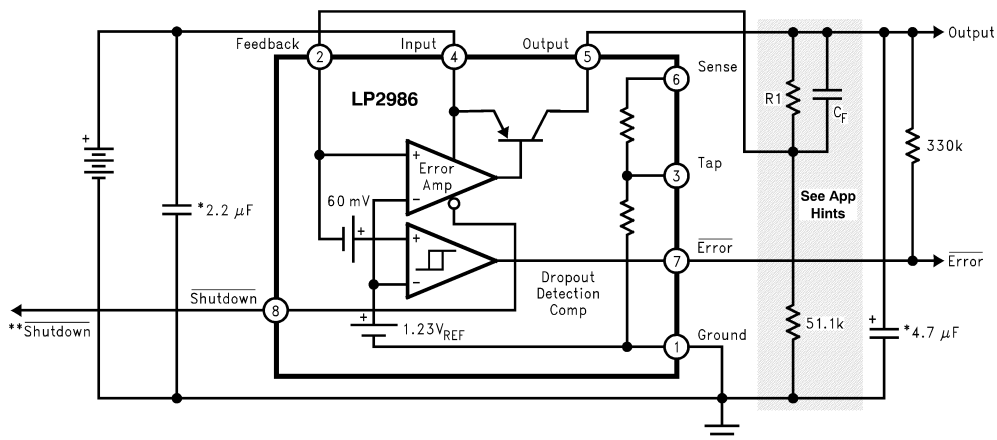

* Minimum capacitance shown to assure stability, but may be increased without limit. Larger output capacitor provides improved dynamic response.

** Shutdown input must be actively terminated. Tie to V_{IN} if not used.

Figure 33. Application Using External Divider

APPLICATION HINTS

WSON PACKAGE DEVICES

The LP2986 is offered in the 8 lead WSON surface mount package to allow for increased power dissipation compared to the SOIC-8 and VSSOP-8. For details on WSON thermal performance as well as mounting and soldering specifications, refer to the [WSON MOUNTING](#) section.

EXTERNAL CAPACITORS

Like any low-dropout regulator, external capacitors are required to assure stability. These capacitors must be correctly selected for proper performance.

INPUT CAPACITOR: An input capacitor ($\geq 2.2 \mu\text{F}$) is required between the LP2986 input and ground (amount of capacitance may be increased without limit).

This capacitor must be located a distance of not more than 0.5" from the input pin and returned to a clean analog ground. Any good quality ceramic or tantalum may be used for this capacitor.

OUTPUT CAPACITOR: The output capacitor must meet the requirement for minimum amount of capacitance and also have an appropriate E.S.R. (equivalent series resistance) value.

Curves are provided which show the allowable ESR range as a function of load current for various output voltages and capacitor values (see ESR curves below).

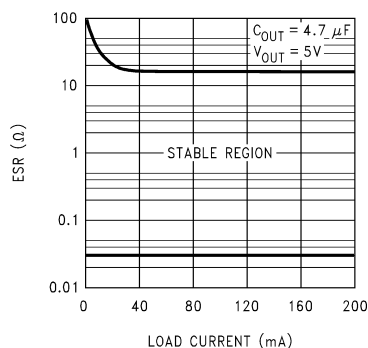

Figure 34. ESR Curves For 5V Output

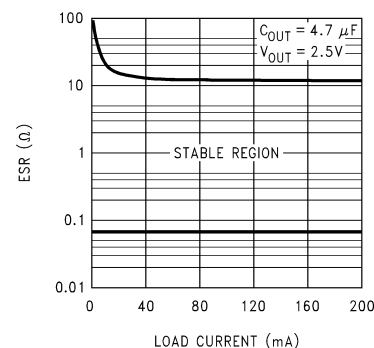

Figure 35. ESR Curves For 2.5V Output

IMPORTANT: The output capacitor must maintain its ESR in the stable region over the full operating temperature range of the application to assure stability.

The minimum required amount of output capacitance is $4.7 \mu\text{F}$. Output capacitor size can be increased without limit.

It is important to remember that capacitor tolerance and variation with temperature must be taken into consideration when selecting an output capacitor so that the minimum required amount of output capacitance is provided over the full operating temperature range. A good Tantalum capacitor will show very little variation with temperature, but a ceramic may not be as good (see next section).

CAPACITOR CHARACTERISTICS

TANTALUM: The best choice for size, cost, and performance are solid tantalum capacitors. Available from many sources, their typical ESR is very close to the ideal value required on the output of many LDO regulators.

Tantalums also have good temperature stability: a $4.7 \mu\text{F}$ was tested and showed only a 10% decline in capacitance as the temperature was decreased from $+125^\circ\text{C}$ to -40°C . The ESR increased only about 2:1 over the same range of temperature.

However, it should be noted that the increasing ESR at lower temperatures present in all tantalums can cause oscillations when marginal quality capacitors are used (where the ESR of the capacitor is near the upper limit of the stability range at room temperature).

CERAMIC: For a given amount of a capacitance, ceramics are usually larger and more costly than tantalums.

Be warned that the ESR of a ceramic capacitor can be low enough to cause instability: a 2.2 μF ceramic was measured and found to have an ESR of about 15 $\text{m}\Omega$.

If a ceramic capacitor is to be used on the LP2986 output, a 1 Ω resistor should be placed in series with the capacitor to provide a minimum ESR for the regulator.

Another disadvantage of ceramic capacitors is that their capacitance varies a lot with temperature:

Large ceramic capacitors are typically manufactured with the Z5U temperature characteristic, which results in the capacitance dropping by a 50% as the temperature goes from 25°C to 80°C.

This means you have to buy a capacitor with twice the minimum C_{OUT} to assure stable operation up to 80°C.

ALUMINUM: The large physical size of aluminum electrolytics makes them unattractive for use with the LP2986. Their ESR characteristics are also not well suited to the requirements of LDO regulators.

The ESR of an aluminum electrolytic is higher than a tantalum, and it also varies greatly with temperature.

A typical aluminum electrolytic can exhibit an ESR increase of 50X when going from 20°C to –40°C. Also, some aluminum electrolytics can not be used below –25°C because the electrolyte will freeze.

USING AN EXTERNAL RESISTIVE DIVIDER

The LP2986 output voltage can be programmed using an external resistive divider (see [Basic Application Circuits](#)).

The resistor connected between the Feedback pin and ground should be 51.1k. The value for the other resistor (R_1) connected between the Feedback pin and the regulated output is found using the formula:

$$V_{\text{OUT}} = V_{\text{FB}} \times (1 + (R_1 / 51.1\text{k})) \quad (1)$$

It should be noted that the 25 μA of current flowing through the external divider is approximately equal to the current saved by not connecting the internal divider, which means the quiescent current is not increased by using external resistors.

A lead compensation capacitor (C_F) must also be used to place a zero in the loop response at about 50 kHz. The value for C_F can be found using:

$$C_F = 1/(2\pi \times R_1 \times 50\text{k}) \quad (2)$$

A good quality capacitor must be used for C_F to ensure that the value is accurate and does not change significantly over temperature. Mica or ceramic capacitors can be used, assuming a tolerance of $\pm 20\%$ or better is selected.

If a ceramic is used, select one with a temperature coefficient of NPO, COG, Y5P, or X7R. Capacitor types Z5U, Y5V, and Z4V can not be used because their value varies more than 50% over the –25°C to +85°C temperature range.

SHUTDOWN INPUT OPERATION

The LP2986 is shut off by driving the Shutdown input low, and turned on by pulling it high. If this feature is not to be used, the Shutdown input should be tied to V_{IN} to keep the regulator output on at all times.

To assure proper operation, the signal source used to drive the Shutdown input must be able to swing above and below the specified turn-on/turn-off voltage thresholds listed as V_H and V_L , respectively (see [Electrical Characteristics](#)).

Since the Shutdown input comparator does not have hysteresis, It is also important that the turn-on (and turn-off) voltage signals applied to the Shutdown input have a slew rate which is not less than 40 $\text{mV}/\mu\text{s}$ when moving between the V_H and V_L thresholds.

CAUTION: The regulator output state (either On or Off) can not be specified if a slow-moving AC (or DC) signal is applied that is in the range between V_H and V_L .

WSON MOUNTING

The LDC08A (Pullback) 8-Lead WSON package requires specific mounting techniques which are detailed in Application Note [AN-1187](#). Referring to the section **PCB Design Recommendations** in [AN-1187](#) (Page 5), it should be noted that the pad style which should be used with this WSON package is the NSMD (non-solder mask defined) type. Additionally, for optimal reliability, there is a recommended 1:1 ratio between the package pad and the PCB pad for the Pullback WSON.

The thermal dissipation of the WSON package is directly related to the printed circuit board construction and the amount of additional copper area connected to the DAP.

The DAP (exposed pad) on the bottom of the WSON package is connected to the die substrate with a conductive die attach adhesive. The DAP has no direct electrical (wire) connection to any of the eight pins. There is a parasitic PN junction between the die substrate and the device ground. As such, it is strongly recommend that the DAP be connected directly to the ground at device lead 1 (i.e. GROUND). Alternately, but not recommended, the DAP may be left floating (i.e. no electrical connection). The DAP must not be connected to any potential other than ground.

For the LP2986 in the NGN0008A 8-Lead WSON package, the junction-to-case thermal rating (θ_{JC}) is 7.2°C/W, where the 'case' is on the bottom of the package at the center of the DAP.

The junction-to-ambient thermal performance for the LP2986 in the NGN0008A 8-Lead WSON package, using the JEDEC JESD51 standards is summarized in the following table:

Board Type	Thermal Vias	θ_{JC}	θ_{JA}
JEDEC 2-Layer JESD 51-3	None	7.2°C/W	184°C/W
JEDEC 4-Layer JESD 51-7	1	7.2°C/W	64°C/W
	2	7.2°C/W	55°C/W
	4	7.2°C/W	46°C/W
	6	7.2°C/W	43°C/W

REVERSE INPUT-OUTPUT VOLTAGE

The PNP power transistor used as the pass element in the LP2986 has an inherent diode connected between the regulator output and input.

During normal operation (where the input voltage is higher than the output) this diode is reverse-biased.

However, if the output voltage is pulled above the input, or the input voltage is pulled below the output, this diode will turn ON and current will flow into the regulator output pin.

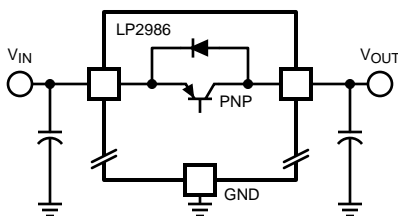

In such cases, a parasitic SCR can latch which will allow a high current to flow into V_{IN} (and out the ground pin), which can damage the part.

In any application where the output voltage may be higher than the input, an external Schottky diode must be connected from V_{IN} to V_{OUT} (cathode on V_{IN} , anode on V_{OUT}), to limit the reverse voltage across the LP2986 to 0.3V (see the [Absolute Maximum Ratings](#) section).

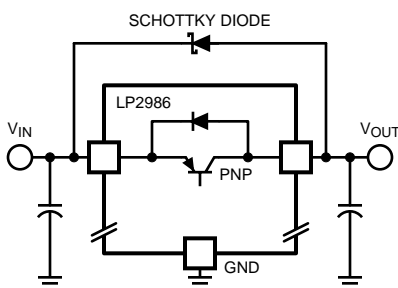

REVISION HISTORY

Changes from Revision G (April 2013) to Revision H	Page
• Changed layout of National Data Sheet to TI format	15

PACKAGING INFORMATION

Orderable Device	Status (1)	Package Type	Package Drawing	Pins	Package Qty	Eco Plan (2)	Lead/Ball Finish (6)	MSL Peak Temp (3)	Op Temp (°C)	Device Marking (4/5)	Samples
LP2986AILD-3.3	NRND	WSO	NGN	8	1000	TBD	Call TI	Call TI	-40 to 125	L005A	
LP2986AILD-3.3/NOPB	ACTIVE	WSO	NGN	8	1000	Green (RoHS & no Sb/Br)	SN	Level-3-260C-168 HR	-40 to 125	L005A	Samples
LP2986AILD-3.3/NOPB	ACTIVE	WSO	NGN	8	4500	Green (RoHS & no Sb/Br)	SN	Level-3-260C-168 HR	-40 to 125	L005A	Samples
LP2986AIM-3.0/NOPB	ACTIVE	SOIC	D	8	95	Green (RoHS & no Sb/Br)	SN CU SN	Level-1-260C-UNLIM	-40 to 125	2986A IM3.0	Samples
LP2986AIM-3.3	NRND	SOIC	D	8	95	TBD	Call TI	Call TI	-40 to 125	2986A IM3.3	
LP2986AIM-3.3/NOPB	ACTIVE	SOIC	D	8	95	Green (RoHS & no Sb/Br)	SN CU SN	Level-1-260C-UNLIM	-40 to 125	2986A IM3.3	Samples
LP2986AIM-5.0	NRND	SOIC	D	8	95	TBD	Call TI	Call TI	-40 to 125	2986A IM5.0	
LP2986AIM-5.0/NOPB	ACTIVE	SOIC	D	8	95	Green (RoHS & no Sb/Br)	CU SN	Level-1-260C-UNLIM	-40 to 125	2986A IM5.0	Samples
LP2986AIMM-3.0/NOPB	ACTIVE	VSSOP	DGK	8	1000	Green (RoHS & no Sb/Br)	CU SN	Level-1-260C-UNLIM	-40 to 125	L39A	Samples
LP2986AIMM-3.3/NOPB	ACTIVE	VSSOP	DGK	8	1000	Green (RoHS & no Sb/Br)	CU SN	Level-1-260C-UNLIM	-40 to 125	L40A	Samples
LP2986AIMM-5.0/NOPB	ACTIVE	VSSOP	DGK	8	1000	Green (RoHS & no Sb/Br)	CU SN	Level-1-260C-UNLIM	-40 to 125	L41A	Samples
LP2986AIMMX-3.0/NOPB	ACTIVE	VSSOP	DGK	8	3500	Green (RoHS & no Sb/Br)	CU SN	Level-1-260C-UNLIM	-40 to 125	L39A	Samples
LP2986AIMMX-3.3/NOPB	ACTIVE	VSSOP	DGK	8	3500	Green (RoHS & no Sb/Br)	CU SN	Level-1-260C-UNLIM	-40 to 125	L40A	Samples
LP2986AIMMX-5.0/NOPB	ACTIVE	VSSOP	DGK	8	3500	Green (RoHS & no Sb/Br)	CU SN	Level-1-260C-UNLIM	-40 to 125	L41A	Samples
LP2986AIMX-3.0/NOPB	ACTIVE	SOIC	D	8	2500	Green (RoHS & no Sb/Br)	CU SN	Level-1-260C-UNLIM	-40 to 125	2986A IM3.0	Samples
LP2986AIMX-3.3/NOPB	ACTIVE	SOIC	D	8	2500	Green (RoHS & no Sb/Br)	SN CU SN	Level-1-260C-UNLIM	-40 to 125	2986A IM3.3	Samples
LP2986AIMX-5.0	NRND	SOIC	D	8	2500	TBD	Call TI	Call TI	-40 to 125	2986A IM5.0	

Orderable Device	Status (1)	Package Type	Package Drawing	Pins	Package Qty	Eco Plan (2)	Lead/Ball Finish (6)	MSL Peak Temp (3)	Op Temp (°C)	Device Marking (4/5)	Samples
LP2986AIMX-5.0/NOPB	ACTIVE	SOIC	D	8	2500	Green (RoHS & no Sb/Br)	CU SN	Level-1-260C-UNLIM	-40 to 125	2986A IM5.0	Samples
LP2986ILD-3.3/NOPB	ACTIVE	WSO8	NGN	8	1000	Green (RoHS & no Sb/Br)	SN	Level-3-260C-168 HR	-40 to 125	L005A B	Samples
LP2986ILD-3.3/NOPB	ACTIVE	WSO8	NGN	8	4500	Green (RoHS & no Sb/Br)	SN	Level-3-260C-168 HR	-40 to 125	L005A B	Samples
LP2986IM-3.0	NRND	SOIC	D	8	95	TBD	Call TI	Call TI	-40 to 125	2986I M3.0	
LP2986IM-3.0/NOPB	ACTIVE	SOIC	D	8	95	Green (RoHS & no Sb/Br)	CU SN	Level-1-260C-UNLIM	-40 to 125	2986I M3.0	Samples
LP2986IM-3.3	NRND	SOIC	D	8	95	TBD	Call TI	Call TI	-40 to 125	2986I M3.3	
LP2986IM-3.3/NOPB	ACTIVE	SOIC	D	8	95	Green (RoHS & no Sb/Br)	CU SN	Level-1-260C-UNLIM	-40 to 125	2986I M3.3	Samples
LP2986IM-5.0	NRND	SOIC	D	8	95	TBD	Call TI	Call TI	-40 to 125	2986I M5.0	
LP2986IM-5.0/NOPB	ACTIVE	SOIC	D	8	95	Green (RoHS & no Sb/Br)	SN CU SN	Level-1-260C-UNLIM	-40 to 125	2986I M5.0	Samples
LP2986IMM-3.0/NOPB	ACTIVE	VSSOP	DGK	8	1000	Green (RoHS & no Sb/Br)	CU SN	Level-1-260C-UNLIM	-40 to 125	L39B	Samples
LP2986IMM-3.3	NRND	VSSOP	DGK	8	1000	TBD	Call TI	Call TI	-40 to 125	L40B	
LP2986IMM-3.3/NOPB	ACTIVE	VSSOP	DGK	8	1000	Green (RoHS & no Sb/Br)	CU SN	Level-1-260C-UNLIM	-40 to 125	L40B	Samples
LP2986IMM-5.0/NOPB	ACTIVE	VSSOP	DGK	8	1000	Green (RoHS & no Sb/Br)	CU SN	Level-1-260C-UNLIM	-40 to 125	L41B	Samples
LP2986IMMX-3.0/NOPB	ACTIVE	VSSOP	DGK	8	3500	Green (RoHS & no Sb/Br)	CU SN	Level-1-260C-UNLIM	-40 to 125	L39B	Samples
LP2986IMMX-3.3/NOPB	ACTIVE	VSSOP	DGK	8	3500	Green (RoHS & no Sb/Br)	CU SN	Level-1-260C-UNLIM	-40 to 125	L40B	Samples
LP2986IMMX-5.0/NOPB	ACTIVE	VSSOP	DGK	8	3500	Green (RoHS & no Sb/Br)	CU SN	Level-1-260C-UNLIM	-40 to 125	L41B	Samples
LP2986IMX-3.0/NOPB	ACTIVE	SOIC	D	8	2500	Green (RoHS & no Sb/Br)	CU SN	Level-1-260C-UNLIM	-40 to 125	2986I M3.0	Samples
LP2986IMX-3.3/NOPB	ACTIVE	SOIC	D	8	2500	Green (RoHS & no Sb/Br)	CU SN	Level-1-260C-UNLIM	-40 to 125	2986I M3.3	Samples
LP2986IMX-5.0	NRND	SOIC	D	8	2500	TBD	Call TI	Call TI	-40 to 125	2986I	

Orderable Device	Status (1)	Package Type	Package Drawing	Pins	Package Qty	Eco Plan (2)	Lead/Ball Finish (6)	MSL Peak Temp (3)	Op Temp (°C)	Device Marking (4/5)	Samples
										M5.0	
LP2986IMX-5.0/NOPB	ACTIVE	SOIC	D	8	2500	Green (RoHS & no Sb/Br)	CU SN	Level-1-260C-UNLIM	-40 to 125	2986I M5.0	Samples

(1) The marketing status values are defined as follows:

ACTIVE: Product device recommended for new designs.

LIFEBUY: TI has announced that the device will be discontinued, and a lifetime-buy period is in effect.

NRND: Not recommended for new designs. Device is in production to support existing customers, but TI does not recommend using this part in a new design.

PREVIEW: Device has been announced but is not in production. Samples may or may not be available.

OBSELETE: TI has discontinued the production of the device.

(2) Eco Plan - The planned eco-friendly classification: Pb-Free (RoHS), Pb-Free (RoHS Exempt), or Green (RoHS & no Sb/Br) - please check <http://www.ti.com/productcontent> for the latest availability information and additional product content details.

TBD: The Pb-Free/Green conversion plan has not been defined.

Pb-Free (RoHS): TI's terms "Lead-Free" or "Pb-Free" mean semiconductor products that are compatible with the current RoHS requirements for all 6 substances, including the requirement that lead not exceed 0.1% by weight in homogeneous materials. Where designed to be soldered at high temperatures, TI Pb-Free products are suitable for use in specified lead-free processes.

Pb-Free (RoHS Exempt): This component has a RoHS exemption for either 1) lead-based flip-chip solder bumps used between the die and package, or 2) lead-based die adhesive used between the die and leadframe. The component is otherwise considered Pb-Free (RoHS compatible) as defined above.

Green (RoHS & no Sb/Br): TI defines "Green" to mean Pb-Free (RoHS compatible), and free of Bromine (Br) and Antimony (Sb) based flame retardants (Br or Sb do not exceed 0.1% by weight in homogeneous material)

(3) MSL, Peak Temp. - The Moisture Sensitivity Level rating according to the JEDEC industry standard classifications, and peak solder temperature.

(4) There may be additional marking, which relates to the logo, the lot trace code information, or the environmental category on the device.

(5) Multiple Device Markings will be inside parentheses. Only one Device Marking contained in parentheses and separated by a "-" will appear on a device. If a line is indented then it is a continuation of the previous line and the two combined represent the entire Device Marking for that device.

(6) Lead/Ball Finish - Orderable Devices may have multiple material finish options. Finish options are separated by a vertical ruled line. Lead/Ball Finish values may wrap to two lines if the finish value exceeds the maximum column width.

Important Information and Disclaimer: The information provided on this page represents TI's knowledge and belief as of the date that it is provided. TI bases its knowledge and belief on information provided by third parties, and makes no representation or warranty as to the accuracy of such information. Efforts are underway to better integrate information from third parties. TI has taken and continues to take reasonable steps to provide representative and accurate information but may not have conducted destructive testing or chemical analysis on incoming materials and chemicals. TI and TI suppliers consider certain information to be proprietary, and thus CAS numbers and other limited information may not be available for release.

In no event shall TI's liability arising out of such information exceed the total purchase price of the TI part(s) at issue in this document sold by TI to Customer on an annual basis.

TAPE AND REEL INFORMATION

QUADRANT ASSIGNMENTS FOR PIN 1 ORIENTATION IN TAPE

*All dimensions are nominal

Device	Package Type	Package Drawing	Pins	SPQ	Reel Diameter (mm)	Reel Width W1 (mm)	A0 (mm)	B0 (mm)	K0 (mm)	P1 (mm)	W (mm)	Pin1 Quadrant
LP2986AILD-3.3	WSON	NGN	8	1000	178.0	12.4	4.3	4.3	1.3	8.0	12.0	Q1
LP2986AILD-3.3/NOPB	WSON	NGN	8	1000	178.0	12.4	4.3	4.3	1.3	8.0	12.0	Q1
LP2986AILD-3.3/NOPB	WSON	NGN	8	4500	330.0	12.4	4.3	4.3	1.3	8.0	12.0	Q1
LP2986AIMM-3.0/NOPB	VSSOP	DGK	8	1000	178.0	12.4	5.3	3.4	1.4	8.0	12.0	Q1
LP2986AIMM-3.3/NOPB	VSSOP	DGK	8	1000	178.0	12.4	5.3	3.4	1.4	8.0	12.0	Q1
LP2986AIMM-5.0/NOPB	VSSOP	DGK	8	1000	178.0	12.4	5.3	3.4	1.4	8.0	12.0	Q1
LP2986AIMMX-3.0/NOPB	VSSOP	DGK	8	3500	330.0	12.4	5.3	3.4	1.4	8.0	12.0	Q1
LP2986AIMMX-3.3/NOPB	VSSOP	DGK	8	3500	330.0	12.4	5.3	3.4	1.4	8.0	12.0	Q1
LP2986AIMMX-5.0/NOPB	VSSOP	DGK	8	3500	330.0	12.4	5.3	3.4	1.4	8.0	12.0	Q1
LP2986AIMX-3.0/NOPB	SOIC	D	8	2500	330.0	12.4	6.5	5.4	2.0	8.0	12.0	Q1
LP2986AIMX-3.3/NOPB	SOIC	D	8	2500	330.0	12.4	6.5	5.4	2.0	8.0	12.0	Q1
LP2986AIMX-5.0	SOIC	D	8	2500	330.0	12.4	6.5	5.4	2.0	8.0	12.0	Q1
LP2986AIMX-5.0/NOPB	SOIC	D	8	2500	330.0	12.4	6.5	5.4	2.0	8.0	12.0	Q1
LP2986ILD-3.3/NOPB	WSON	NGN	8	1000	178.0	12.4	4.3	4.3	1.3	8.0	12.0	Q1
LP2986ILD-3.3/NOPB	WSON	NGN	8	4500	330.0	12.4	4.3	4.3	1.3	8.0	12.0	Q1
LP2986IMM-3.0/NOPB	VSSOP	DGK	8	1000	178.0	12.4	5.3	3.4	1.4	8.0	12.0	Q1
LP2986IMM-3.3	VSSOP	DGK	8	1000	178.0	12.4	5.3	3.4	1.4	8.0	12.0	Q1
LP2986IMM-3.3/NOPB	VSSOP	DGK	8	1000	178.0	12.4	5.3	3.4	1.4	8.0	12.0	Q1

Device	Package Type	Package Drawing	Pins	SPQ	Reel Diameter (mm)	Reel Width W1 (mm)	A0 (mm)	B0 (mm)	K0 (mm)	P1 (mm)	W (mm)	Pin1 Quadrant
LP2986IMM-5.0/NOPB	VSSOP	DGK	8	1000	178.0	12.4	5.3	3.4	1.4	8.0	12.0	Q1
LP2986IMMX-3.0/NOPB	VSSOP	DGK	8	3500	330.0	12.4	5.3	3.4	1.4	8.0	12.0	Q1
LP2986IMMX-3.3/NOPB	VSSOP	DGK	8	3500	330.0	12.4	5.3	3.4	1.4	8.0	12.0	Q1
LP2986IMMX-5.0/NOPB	VSSOP	DGK	8	3500	330.0	12.4	5.3	3.4	1.4	8.0	12.0	Q1
LP2986IMX-3.0/NOPB	SOIC	D	8	2500	330.0	12.4	6.5	5.4	2.0	8.0	12.0	Q1
LP2986IMX-3.3/NOPB	SOIC	D	8	2500	330.0	12.4	6.5	5.4	2.0	8.0 <td 12.0	Q1	
LP2986IMX-5.0	SOIC	D	8	2500	330.0	12.4	6.5	5.4	2.0	8.0	12.0	Q1
LP2986IMX-5.0/NOPB	SOIC	D	8	2500	330.0	12.4	6.5	5.4	2.0	8.0	12.0	Q1

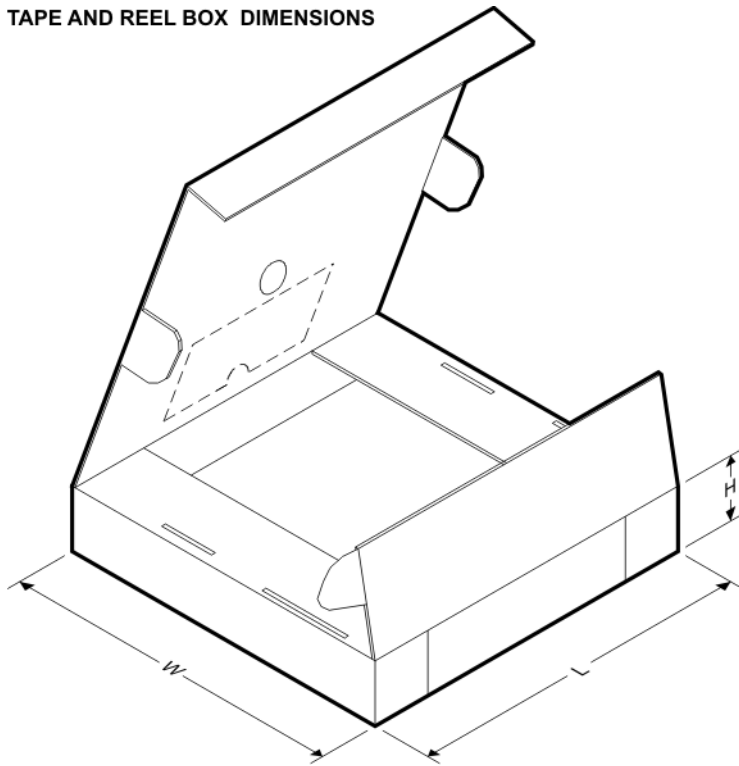
TAPE AND REEL BOX DIMENSIONS

*All dimensions are nominal

Device	Package Type	Package Drawing	Pins	SPQ	Length (mm)	Width (mm)	Height (mm)
LP2986AILD-3.3	WSON	NGN	8	1000	210.0	185.0	35.0
LP2986AILD-3.3/NOPB	WSON	NGN	8	1000	213.0	191.0	55.0
LP2986AILD-3.3/NOPB	WSON	NGN	8	4500	367.0	367.0	35.0
LP2986AIMM-3.0/NOPB	VSSOP	DGK	8	1000	210.0	185.0	35.0
LP2986AIMM-3.3/NOPB	VSSOP	DGK	8	1000	210.0	185.0	35.0
LP2986AIMM-5.0/NOPB	VSSOP	DGK	8	1000	210.0	185.0	35.0
LP2986AIMMX-3.0/NOPB	VSSOP	DGK	8	3500	367.0	367.0	35.0
LP2986AIMMX-3.3/NOPB	VSSOP	DGK	8	3500	367.0	367.0	35.0
LP2986AIMMX-5.0/NOPB	VSSOP	DGK	8	3500	367.0	367.0	35.0

Device	Package Type	Package Drawing	Pins	SPQ	Length (mm)	Width (mm)	Height (mm)
LP2986AIMX-3.0/NOPB	SOIC	D	8	2500	367.0	367.0	35.0
LP2986AIMX-3.3/NOPB	SOIC	D	8	2500	367.0	367.0	35.0
LP2986AIMX-5.0	SOIC	D	8	2500	367.0	367.0	35.0
LP2986AIMX-5.0/NOPB	SOIC	D	8	2500	367.0	367.0	35.0
LP2986ILD-3.3/NOPB	WSON	NGN	8	1000	213.0	191.0	55.0
LP2986ILD-3.3/NOPB	WSON	NGN	8	4500	367.0	367.0	35.0
LP2986IMM-3.0/NOPB	VSSOP	DGK	8	1000	210.0	185.0	35.0
LP2986IMM-3.3	VSSOP	DGK	8	1000	210.0	185.0	35.0
LP2986IMM-3.3/NOPB	VSSOP	DGK	8	1000	210.0	185.0	35.0
LP2986IMM-5.0/NOPB	VSSOP	DGK	8	1000	210.0	185.0	35.0
LP2986IMMX-3.0/NOPB	VSSOP	DGK	8	3500	367.0	367.0	35.0
LP2986IMMX-3.3/NOPB	VSSOP	DGK	8	3500	367.0	367.0	35.0
LP2986IMMX-5.0/NOPB	VSSOP	DGK	8	3500	367.0	367.0	35.0
LP2986IMX-3.0/NOPB	SOIC	D	8	2500	367.0	367.0	35.0
LP2986IMX-3.3/NOPB	SOIC	D	8	2500	367.0	367.0	35.0
LP2986IMX-5.0	SOIC	D	8	2500	367.0	367.0	35.0
LP2986IMX-5.0/NOPB	SOIC	D	8	2500	367.0	367.0	35.0

DGK (S-PDSO-G8)

PLASTIC SMALL-OUTLINE PACKAGE

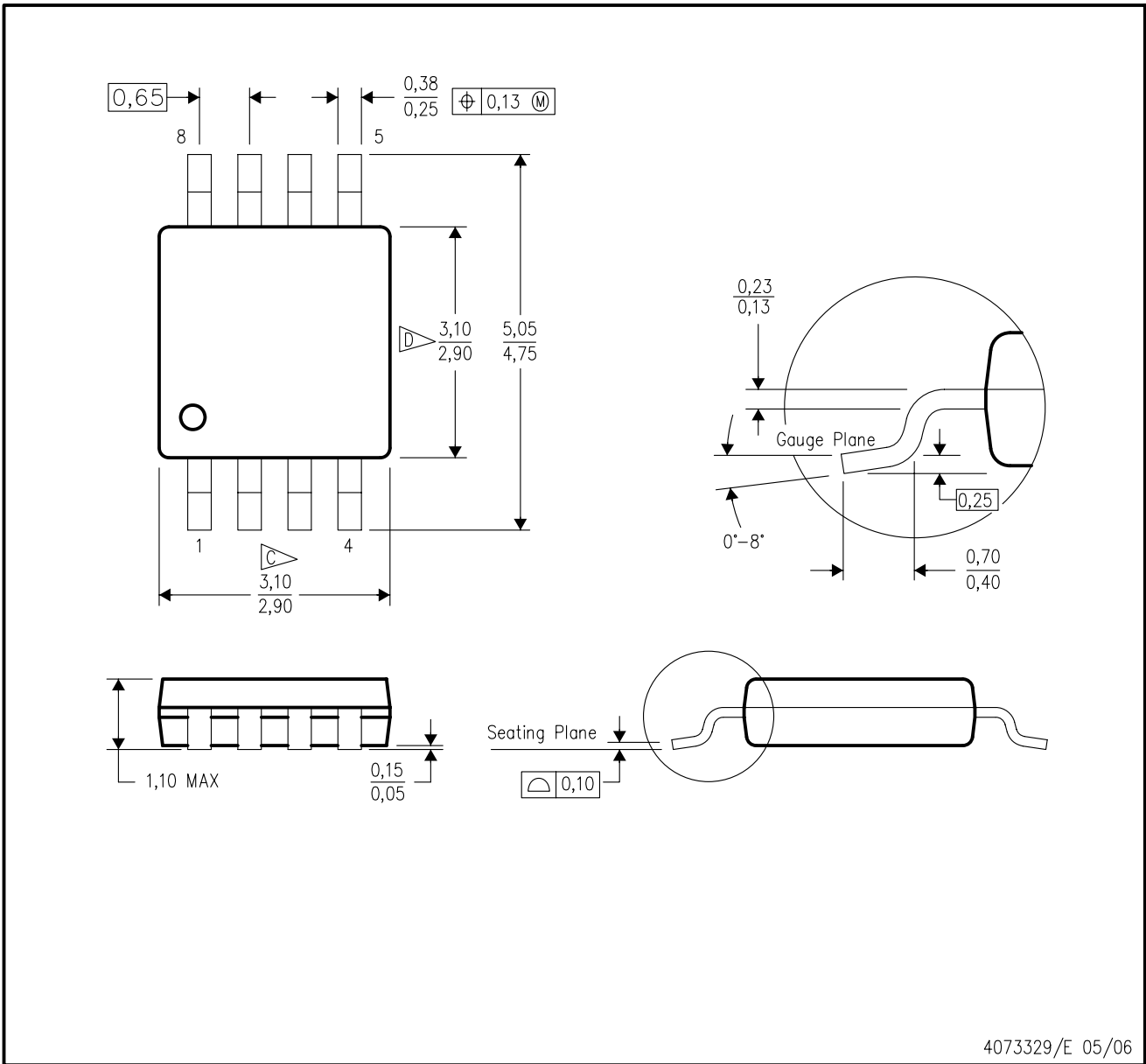

- NOTES:
- A. All linear dimensions are in millimeters.
 - B. This drawing is subject to change without notice.
 - C. Body length does not include mold flash, protrusions, or gate burrs. Mold flash, protrusions, or gate burrs shall not exceed 0.15 per end.
 - D. Body width does not include interlead flash. Interlead flash shall not exceed 0.50 per side.
 - E. Falls within JEDEC MO-187 variation AA, except interlead flash.

NGN0008A

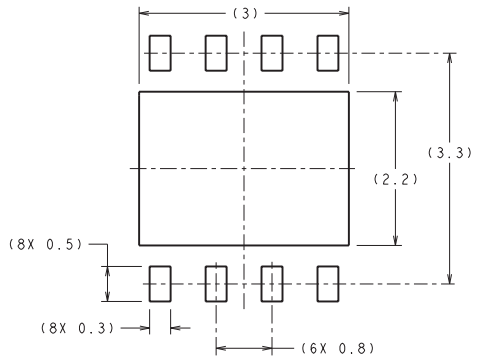

RECOMMENDED LAND PATTERN
 1:1 RATION WITH PKG SOLDER PADS

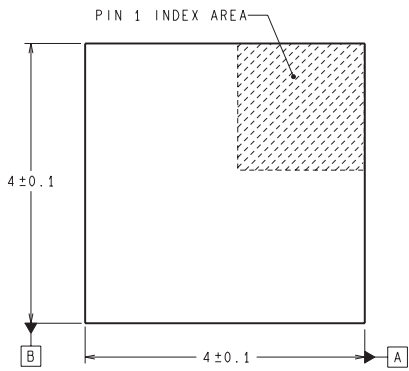

DIMENSIONS ARE IN MILLIMETERS
 DIMENSIONS IN () FOR REFERENCE ONLY

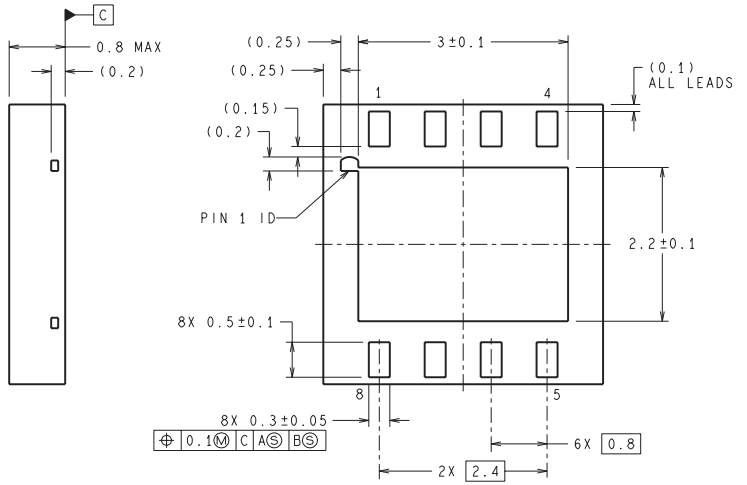

LDC08A (Rev B)

D (R-PDSO-G8)

PLASTIC SMALL OUTLINE



NOTES: A. All linear dimensions are in inches (millimeters).
 B. This drawing is subject to change without notice.
 C. Body length does not include mold flash, protrusions, or gate burrs. Mold flash, protrusions, or gate burrs shall not exceed 0.006 (0,15) each side.
 D. Body width does not include interlead flash. Interlead flash shall not exceed 0.017 (0,43) each side.
 E. Reference JEDEC MS-012 variation AA.

IMPORTANT NOTICE

Texas Instruments Incorporated and its subsidiaries (TI) reserve the right to make corrections, enhancements, improvements and other changes to its semiconductor products and services per JESD46, latest issue, and to discontinue any product or service per JESD48, latest issue. Buyers should obtain the latest relevant information before placing orders and should verify that such information is current and complete. All semiconductor products (also referred to herein as "components") are sold subject to TI's terms and conditions of sale supplied at the time of order acknowledgment.

TI warrants performance of its components to the specifications applicable at the time of sale, in accordance with the warranty in TI's terms and conditions of sale of semiconductor products. Testing and other quality control techniques are used to the extent TI deems necessary to support this warranty. Except where mandated by applicable law, testing of all parameters of each component is not necessarily performed.

TI assumes no liability for applications assistance or the design of Buyers' products. Buyers are responsible for their products and applications using TI components. To minimize the risks associated with Buyers' products and applications, Buyers should provide adequate design and operating safeguards.

TI does not warrant or represent that any license, either express or implied, is granted under any patent right, copyright, mask work right, or other intellectual property right relating to any combination, machine, or process in which TI components or services are used. Information published by TI regarding third-party products or services does not constitute a license to use such products or services or a warranty or endorsement thereof. Use of such information may require a license from a third party under the patents or other intellectual property of the third party, or a license from TI under the patents or other intellectual property of TI.

Reproduction of significant portions of TI information in TI data books or data sheets is permissible only if reproduction is without alteration and is accompanied by all associated warranties, conditions, limitations, and notices. TI is not responsible or liable for such altered documentation. Information of third parties may be subject to additional restrictions.

Resale of TI components or services with statements different from or beyond the parameters stated by TI for that component or service voids all express and any implied warranties for the associated TI component or service and is an unfair and deceptive business practice. TI is not responsible or liable for any such statements.

Buyer acknowledges and agrees that it is solely responsible for compliance with all legal, regulatory and safety-related requirements concerning its products, and any use of TI components in its applications, notwithstanding any applications-related information or support that may be provided by TI. Buyer represents and agrees that it has all the necessary expertise to create and implement safeguards which anticipate dangerous consequences of failures, monitor failures and their consequences, lessen the likelihood of failures that might cause harm and take appropriate remedial actions. Buyer will fully indemnify TI and its representatives against any damages arising out of the use of any TI components in safety-critical applications.

In some cases, TI components may be promoted specifically to facilitate safety-related applications. With such components, TI's goal is to help enable customers to design and create their own end-product solutions that meet applicable functional safety standards and requirements. Nonetheless, such components are subject to these terms.

No TI components are authorized for use in FDA Class III (or similar life-critical medical equipment) unless authorized officers of the parties have executed a special agreement specifically governing such use.

Only those TI components which TI has specifically designated as military grade or "enhanced plastic" are designed and intended for use in military/aerospace applications or environments. Buyer acknowledges and agrees that any military or aerospace use of TI components which have **not** been so designated is solely at the Buyer's risk, and that Buyer is solely responsible for compliance with all legal and regulatory requirements in connection with such use.

TI has specifically designated certain components as meeting ISO/TS16949 requirements, mainly for automotive use. In any case of use of non-designated products, TI will not be responsible for any failure to meet ISO/TS16949.

Products

Audio	www.ti.com/audio
Amplifiers	amplifier.ti.com
Data Converters	dataconverter.ti.com
DLP® Products	www.dlp.com
DSP	dsp.ti.com
Clocks and Timers	www.ti.com/clocks
Interface	interface.ti.com
Logic	logic.ti.com
Power Mgmt	power.ti.com
Microcontrollers	microcontroller.ti.com
RFID	www.ti-rfid.com
OMAP Applications Processors	www.ti.com/omap
Wireless Connectivity	www.ti.com/wirelessconnectivity

Applications

Automotive and Transportation	www.ti.com/automotive
Communications and Telecom	www.ti.com/communications
Computers and Peripherals	www.ti.com/computers
Consumer Electronics	www.ti.com/consumer-apps
Energy and Lighting	www.ti.com/energy
Industrial	www.ti.com/industrial
Medical	www.ti.com/medical
Security	www.ti.com/security
Space, Avionics and Defense	www.ti.com/space-avionics-defense
Video and Imaging	www.ti.com/video

TI E2E Community

e2e.ti.com