

# High Power 2 Way-90° Power Splitter

QCH-652+

50Ω 2 Way-90° Up to 60W\* 1000 to 6500 MHz

## The Big Deal

- High power handling up to 60W
- Ultra wide bandwidth
- Good Amplitude Unbalance, 0.80 dB
- Good Phase Unbalance, ±5 deg



CASE STYLE: PQ2181

## Product Overview

Mini-Circuits' new 2-way 90° power splitter, QCH-652+ capable of handling up to 60W with amplitude unbalance of 0.80 dB typ and phase unbalance of ±5 deg. typ. Operating over a frequency range of 1000 to 6500 MHz, the good phase and amplitude unbalance make this component a versatile building block for use in a variety of systems and sub-system designs from balanced amplifiers and antenna feeds to military applications and more. The splitter is fabricated using laminated PCB process (1.8 x 0.4 x 0.19") and includes wrap-around terminations for good solderability and easy visual inspection.

## Key Features

Feature	Advantages
Ultra wide bandwidth	The QCH-652+ wide band width (1000 - 6500 MHz) makes it suitable for a wide range of applications.
High power handling: 60W @ +85°C 40W @ +105°C	Usable in many systems with high-power requirements such as antenna feeds, power amplifiers, and others that require balanced high power outputs.
Good Phase and Amplitude Unbalance: • 0.80 dB Amplitude Unbalance • ±5° Phase Unbalance	QCH-652+ produces nearly equal signals with 90° phase shift - ideal for I/Q systems, balanced amplifiers, antenna feeds, phase shifters, and many more applications.

\*See power derating on page 2



# High Power Power Splitter/Combiner

## QCH-652+

50Ω 2 Way-90° Up to 60W\* 1000 to 6500 MHz



CASE STYLE: PQ2181

### Maximum Ratings

Operating Temperature, case**	-55°C to 105°C
Storage Temperature	-55°C to 105°C
Power Input*	60W @ +85°C, case

\*Derate to 50W at +95°C and 40W at +105°C case temperature  
 \*\*Case temperature is defined as temperature on base plate.  
 Permanent damage may occur if any of these limits are exceeded.

### Pad Connections\*\*\*

SUM	1
ISOLATION	2
PORT 1 (0°)	3
PORT 2 (+90°)	4
GROUND	5

\*\*\*Model is symmetrical and all ports are interchangeable, see port configuration table.

### Features

- high power, up to 60W
- ultra wide bandwidth
- good amplitude unbalance, 0.80 dB Typ
- good phase unbalance, ±5 deg Typ

### Applications

- Balanced amplifiers
- I&Q Modulators
- Defense and military

### +RoHS Compliant

The +Suffix identifies RoHS Compliance. See our web site for RoHS Compliance methodologies and qualifications

### Outline Drawing

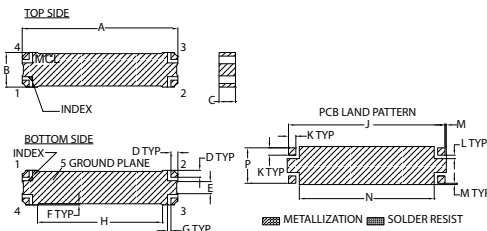

Base material: Printed wiring laminate.  
 Termination Finish: 2-5 µinch (0.05-0.13 microns) Immersion Gold

### Outline Dimensions (inch/mm)

A	B	C	D	E	F	G	
1.800	.400	.190	.080	.140	.013	.040	
45.72	10.16	4.83	2.03	3.56	0.33	1.02	
H	J	K	L	M	N	P	wt.
1.446	1.810	.085	.040	.015	1.560	.410	grams
36.73	45.97	2.16	1.02	0.38	39.62	10.41	1.0

### Demo Board MCL P/N: TB-998+ Suggested PCB Layout (PL-539)

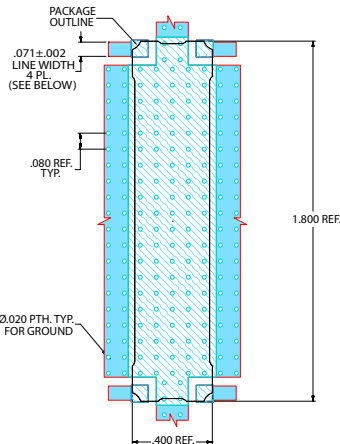

- NOTES:
1. TRACE WIDTH IS SHOWN FOR ROGERS RO4003C WITH DIELECTRIC THICKNESS. 0.032"±.003". COPPER: 1 OZ. EACH SIDE. FOR OTHER MATERIALS TRACE WIDTH MAY NEED TO BE MODIFIED.
  2. BOTTOM SIDE OF THE PCB IS CONTINUOUS GROUND PLANE.
- DENOTES PCB COPPER LAYOUT WITH SMOBC (SOLDER MASK OVER BARE COPPER)
- DENOTES COPPER LAND PATTERN FREE OF SOLDERMASK

### Electrical Specifications @ +25°C

Parameter	Condition (MHz)	Min.	Typ.	Max.	Units
Frequency Range		1000		6500	MHz
Insertion Loss (Avg. of Coupled outputs less 3 dB)	1000 - 6500	—	0.60	1.20	dB
Isolation	1000 - 6500	13.5	19	—	dB
Phase Unbalance	1000 - 6500	—	±5	—	deg
Amplitude Unbalance (Peak-to-Peak)	1000 - 6400	—	0.80	1.60	dB
	6400 - 6500	—	1.10	1.80	
VSWR	1000 - 6500	—	1.20	1.60	:1
Input RF Power	@+85°C, case	1000 - 6500	—	60	W
	@+95°C, case	1000 - 6500	—	50	
	@+105°C, case	1000 - 6500	—	40	
Thermal Resistance	1000 - 6500	—	1	—	°C/W

### Electrical Schematic

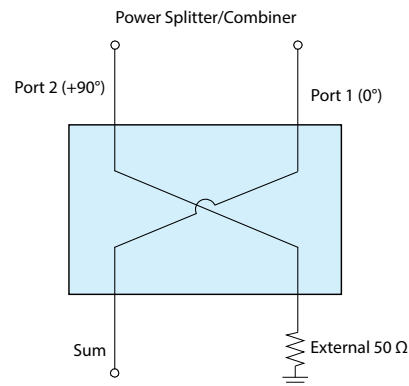

### Port Function Configurations

Config.	Sum	Isolation	Port 1 (0°)	Port 2 (90°)
A	1	2	3	4
B	2	1	4	3
C	3	4	1	2
D	4	3	2	1

## Typical Performance Data <sup>1</sup>

Frequency (MHz)	Total Loss <sup>2</sup> (dB) Sum to Port 1			Total Loss <sup>2</sup> (dB) Sum to Port 2			Amplitude Unbalance (dB) Peak-Peak	Phase Unbalance (deg) Relative to 90°	Isolation (dB) Sum to Isolation			VSWR (:1) Sum Port 1 Port 2 Iso			
	-55°C	+25°C	+105°C	-55°C	+25°C	+105°C			-55°C	+25°C	+105°C	Sum	Port 1	Port 2	Iso
	1000	2.77	2.74	2.72	3.52	3.56			3.58	0.82	0.33	30.90	31.16	33.87	1.04
1300	3.42	3.38	3.36	2.88	2.92	2.94	0.47	0.44	31.39	33.16	32.64	1.05	1.03	1.05	1.05
1600	3.79	3.76	3.73	2.62	2.67	2.68	1.09	0.59	27.31	26.99	25.77	1.11	1.08	1.11	1.08
1900	3.93	3.90	3.85	2.60	2.65	2.66	1.25	0.81	22.79	22.62	22.21	1.17	1.14	1.15	1.12
2200	3.88	3.84	3.79	2.72	2.77	2.78	1.07	0.61	19.93	19.81	19.87	1.19	1.18	1.17	1.17
2500	3.79	3.77	3.72	2.89	2.94	2.93	0.83	-0.91	18.17	18.30	18.59	1.22	1.22	1.22	1.24
2800	3.79	3.78	3.71	3.01	3.04	3.05	0.75	-1.99	17.50	17.73	18.12	1.27	1.26	1.25	1.29
3100	3.74	3.73	3.65	3.04	3.13	3.13	0.60	-1.35	17.93	18.01	18.41	1.31	1.27	1.27	1.30
3400	3.51	3.53	3.47	3.20	3.31	3.31	0.22	-0.15	19.85	19.14	19.35	1.28	1.21	1.23	1.26
3600	3.35	3.35	3.31	3.36	3.45	3.45	0.09	-0.04	21.46	20.43	20.51	1.23	1.14	1.19	1.21
3800	3.20	3.17	3.15	3.51	3.57	3.59	0.40	-0.46	23.83	22.64	22.48	1.17	1.07	1.14	1.16
4000	3.08	3.08	3.03	3.62	3.65	3.67	0.56	-1.11	28.32	26.32	25.68	1.11	1.05	1.10	1.11
4300	3.04	3.04	3.00	3.71	3.70	3.74	0.66	-1.65	34.36	41.12	37.32	1.03	1.09	1.15	1.04
4600	3.17	3.16	3.11	3.67	3.66	3.72	0.50	-2.15	25.12	26.85	27.83	1.04	1.20	1.26	1.14
4900	3.52	3.47	3.44	3.44	3.55	3.58	0.08	-2.45	21.95	21.13	21.47	1.14	1.34	1.32	1.27
5200	3.95	3.93	3.91	3.28	3.41	3.42	0.52	-2.37	19.23	18.04	18.13	1.29	1.42	1.37	1.37
5500	4.31	4.27	4.31	3.33	3.31	3.29	0.95	-1.24	16.96	16.35	16.21	1.46	1.40	1.43	1.43
5800	4.36	4.29	4.29	3.32	3.32	3.34	0.98	-0.18	15.53	15.34	15.43	1.55	1.28	1.41	1.41
6100	4.05	3.92	3.95	3.51	3.50	3.54	0.43	-0.53	14.71	15.01	15.37	1.52	1.14	1.30	1.38
6400	3.47	3.37	3.37	4.15	4.11	4.17	0.76	-2.02	14.46	14.86	15.20	1.43	1.11	1.17	1.34
6500	3.21	3.14	3.16	4.50	4.42	4.53	1.29	-2.71	14.41	14.94	15.00	1.39	1.14	1.17	1.31

1. Data corresponds to Configuration A at +25°C unless specified otherwise.  
 2. Total loss is the loss from Sum to each coupled port including the 3dB theoretical split.

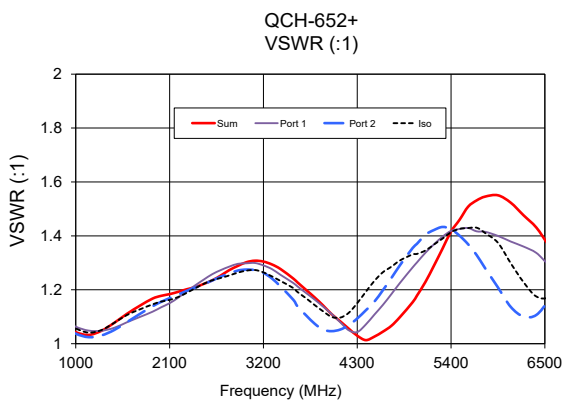
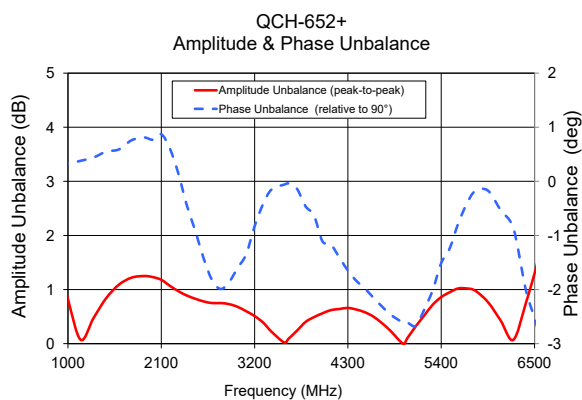
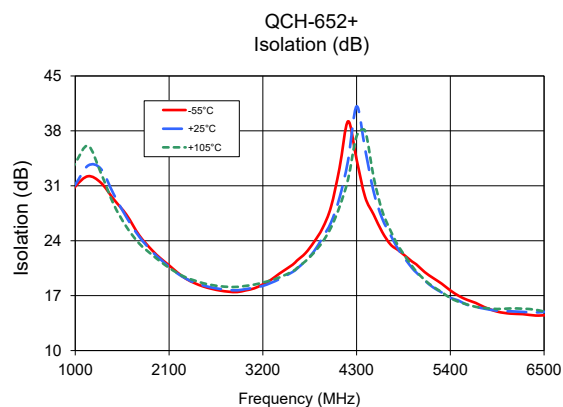
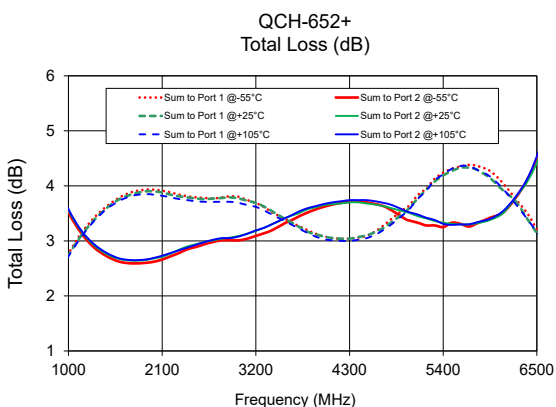

### Additional Notes

- A. Performance and quality attributes and conditions not expressly stated in this specification document are intended to be excluded and do not form a part of this specification document.
- B. Electrical specifications and performance data contained in this specification document are based on Mini-Circuit's applicable established test performance criteria and measurement instructions.
- C. The parts covered by this specification document are subject to Mini-Circuits standard limited warranty and terms and conditions (collectively, "Standard Terms"); Purchasers of this part are entitled to the rights and benefits contained therein. For a full statement of the Standard Terms and the exclusive rights and remedies thereunder, please visit Mini-Circuits' website at [www.minicircuits.com/MCLStore/terms.jsp](http://www.minicircuits.com/MCLStore/terms.jsp)