



Spec. No.	PS-0805-007
Rev.	A

PRODUCT SPECIFICATION

Model No : CSHV-NL60SWA4-A2

Descriptions:
<ul style="list-style-type: none"> • LED Type : High Power VEGA • LED Package : Focusing • Emitting Color : White • Viewing Angle : 60° • Silicone LENS



CUSTOMER APPROVED SIGNATURES	APPROVED BY	CHECKED BY	PREPARED BY

CHINA SEMICONDUCTOR CORPORATION
Address:2FL. NO.909,Chung-Cheng Road,
Chung-Ho City Taipei Hsien,Taiwan.

Tel:886-2-2223-9696
Fax:886-2-2223-9377

OPTO PLUS TECHNOLOGIES CO.,LTD
Address:696 Shun jiang Rd.,Ji Shan St.Shaoxing,
ZheJiang,China

Tel:86-0575-88623888
Fax:86-0575-88623112



Spec. No.	PS-0805-007
Rev.	A

Model No : CSHV-NL60SWA4-A2

Features -

1. High Luminous Output : 80 lm
2. Silicone Encapsulation
3. RoHs Compliant
4. Compatible Lead-Free Reflow Solder
5. ESD>8KV(HBM)
6. Standard Collimator Compatible
7. Low thermal resistance (junction to Case) : 10 °C/W

Device Selection Guide -

Part No.	Chip		LED Lens
	Material	Emitted Color	
CSHV-NL60SWA4-A2	InGaN	White	Water Transparent

Package Outline Dimensions -

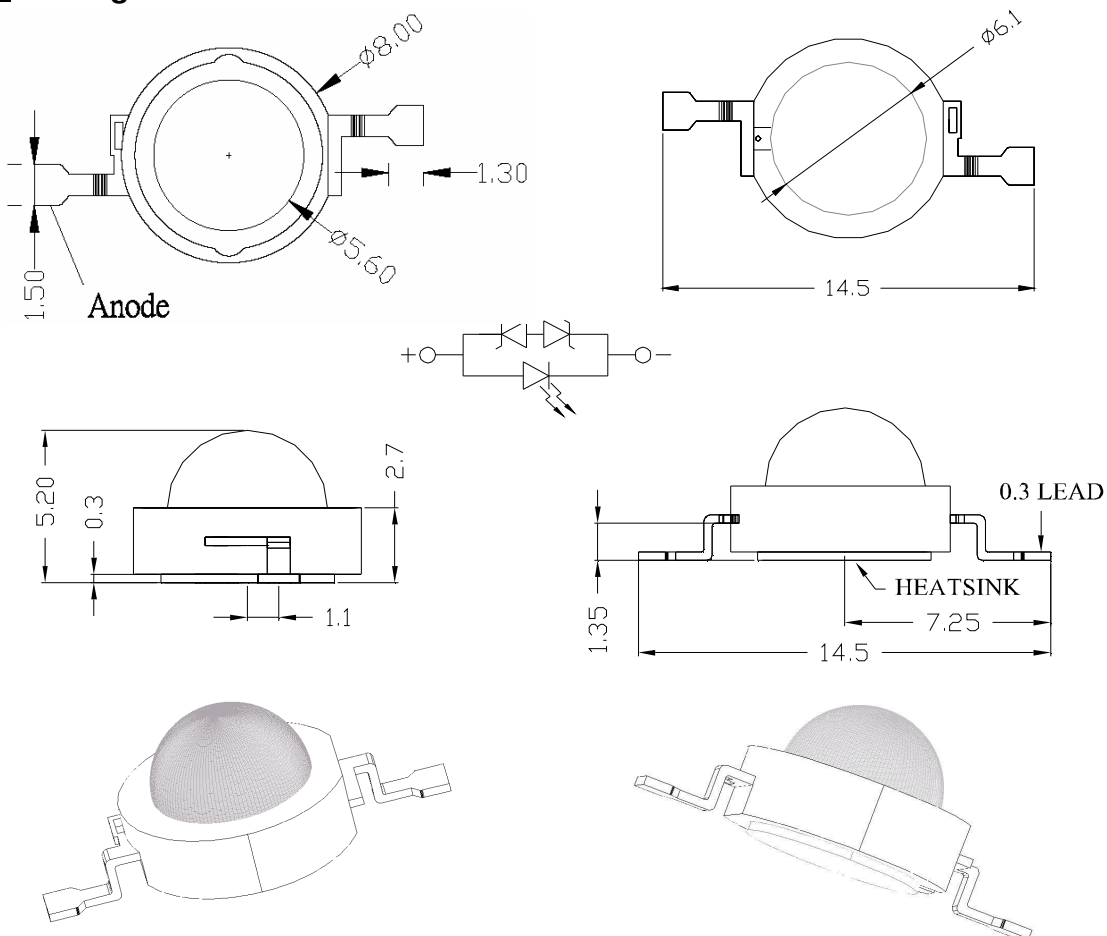

Notes: Tolerance of measurement of Dimension: $\pm 0.25\text{mm}$



Model No : CSHV-NL60SWA4-A2

■ Absolute Maximum Rating -

(Ta=25°C)

Parameter	Symbol	Rating	Unit
Power Dissipation	Pd	2	W
Forward Current (DC)	IF	500	mA
Peak Forward Current *	IFP	750	mA
Reverse Voltage	VR	5	V
Operating Temp.	Topr	-40 ~ +85	°C
Storage Temp.	Tstg	-40 ~ +100	°C

* Pulse width \leq 0.1 msec. duty \leq 1/10

■ Electro-optical Characteristics -

(Ta=25°C)

Parameter	Symbol	Min.	Typ.	Max.	Unit	Condition
Forward Voltage	VF	-----	3.4	4	V	IF=350mA
Luminous Flux	Φv	70	80	-----	lm	
Viewing Angle	2θ 1/2	-----	60	-----	deg	
Reverse Current	IR	-----	-----	50	μA	VR=5V



Model No : CSHV-NL60SWA4-A2

■ Luminous Flux Rank Limits ($I_f = 350\text{mA}$)

unit : lm

Part No.	CSHV-NL60SWA4-A2	
Code	min.	max.
L	70	80
M	80	90
N	90	100
P	100	120

■ Color Rank Limits ($I_f = 350\text{mA}$)

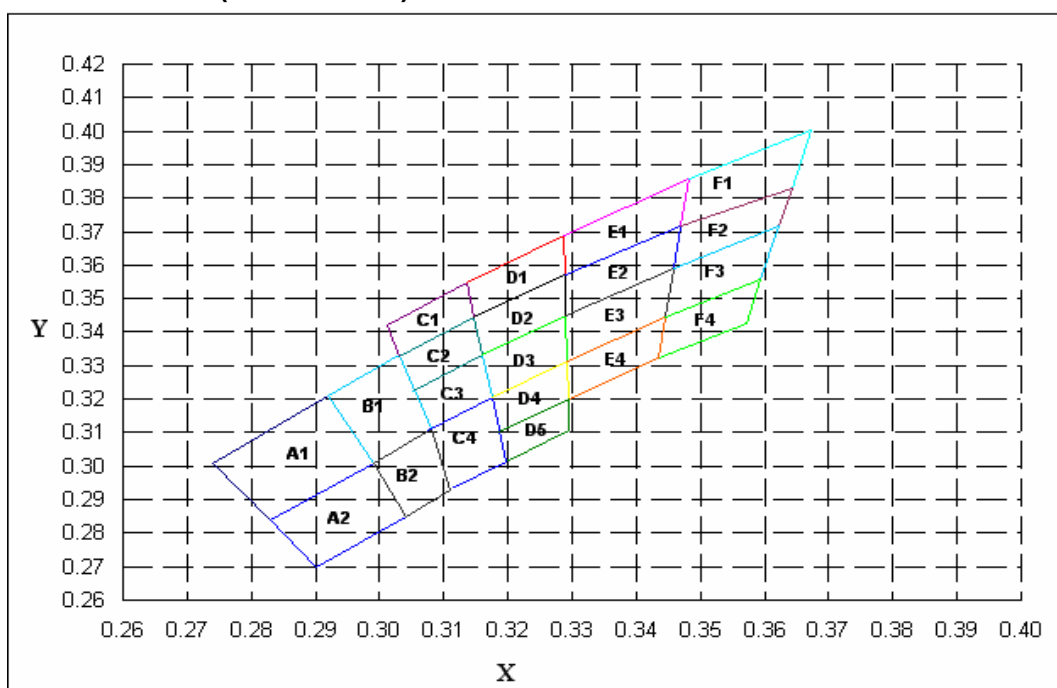

Rank A Color Temperature:8000~10000K									
A1					A2				
X	0.2920	0.2740	0.2830	0.2990	X	0.3040	0.2900	0.2830	0.2990
Y	0.3210	0.3010	0.2840	0.3010	Y	0.2850	0.2700	0.2840	0.3010

Rank B Color Temperature:6700~8000K									
B1					B2				
X	0.2990	0.2920	0.3030	0.3080	X	0.3040	0.2990	0.3080	0.3110
Y	0.3010	0.3210	0.3330	0.3110	Y	0.2850	0.3010	0.3110	0.2930

Rank C Color Temperature:6000~6700K									
C1					C3				
X	0.3011	0.3136	0.3148	0.3031	X	0.3052	0.3160	0.3175	0.3076
Y	0.3422	0.3550	0.3444	0.3327	Y	0.3224	0.3332	0.3204	0.3108
C2					C4				
X	0.3031	0.3148	0.3160	0.3052	X	0.3076	0.3175	0.3196	0.3112
Y	0.3327	0.3444	0.3332	0.3224	Y	0.3108	0.3204	0.3013	0.2932



Model No : CSHV-NL60SWA4-A2

Color Rank Limits (I_F = 350mA)

Rank D Color Temperature:5300~6000K									
D1					D4				
X	0.3136	0.3286	0.3288	0.3148	X	0.3175	0.3292	0.3294	0.3186
Y	0.3560	0.3690	0.3569	0.3444	Y	0.3204	0.3313	0.3202	0.3102
D2					D5				
X	0.3148	0.3288	0.3290	0.3160	X	0.3186	0.3294	0.3295	0.3196
Y	0.3444	0.3569	0.3451	0.3332	Y	0.3102	0.3202	0.3105	0.3013
D3									
X	0.3160	0.3290	0.3292	0.3175					
Y	0.3332	0.3451	0.3313	0.3204					

Rank E Color Temperature:4750~5300K									
E1					E3				
X	0.3286	0.3481	0.3469	0.3288	X	0.3290	0.3458	0.3444	0.3292
Y	0.3690	0.3856	0.3717	0.3569	Y	0.3451	0.3592	0.3442	0.3313
E2					E4				
X	0.3288	0.3469	0.3458	0.3290	X	0.3292	0.3444	0.3434	0.3294
Y	0.3569	0.3717	0.3592	0.3451	Y	0.3313	0.3442	0.3320	0.3202

Rank F Color Temperature:4300~4750K									
F1					F3				
X	0.3481	0.3673	0.3642	0.3469	X	0.3458	0.3622	0.3594	0.3444
Y	0.3856	0.4003	0.3829	0.3717	Y	0.3592	0.3716	0.3557	0.3442
F2					F4				
X	0.3469	0.3642	0.3622	0.3458	X	0.3444	0.3594	0.3571	0.3434
Y	0.3717	0.3829	0.3716	0.3592	Y	0.3442	0.3557	0.3426	0.3320

Notes:

1. Tolerance of measurement of luminous Flux ±10%
2. Tolerance of measurement of Color Coordinates ±0.01
3. All data are measured by CSC's test equipment.
4. Please confirm with CSC salesman, if your request different from standard specification.



Model No : CSHV-NL60SWA4-A2

Typical Electrical / Optical Characteristics Curves -

(Ta = 25°C Unless Otherwise Noted)

Fig 1. Relative Luminous Flux vs. Forward Current

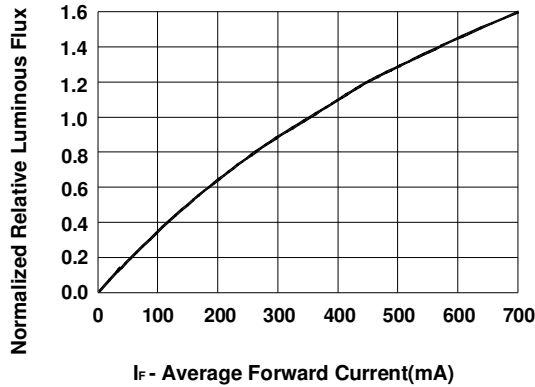

Fig 2. Forward Current vs. Forward Voltage

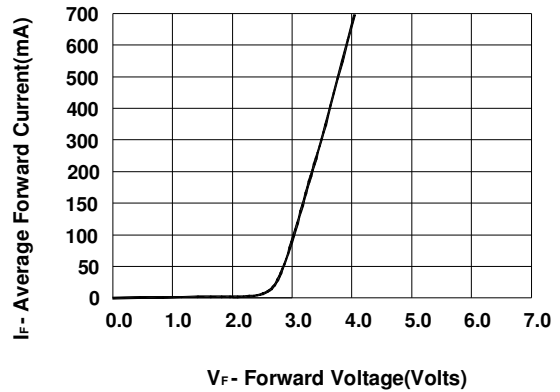

Fig 3. Maximum Forward Current vs. Ambient Temperature. Derating based on T_{JMAX} = 120°C

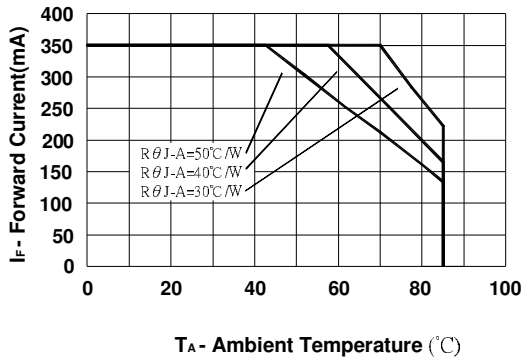

Fig 4. Relative Light Output vs. Junction Temperature

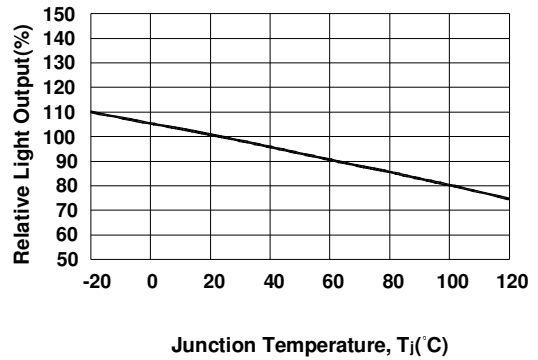

Fig 5. Relative Spectral Power Distribution vs. Wavelength

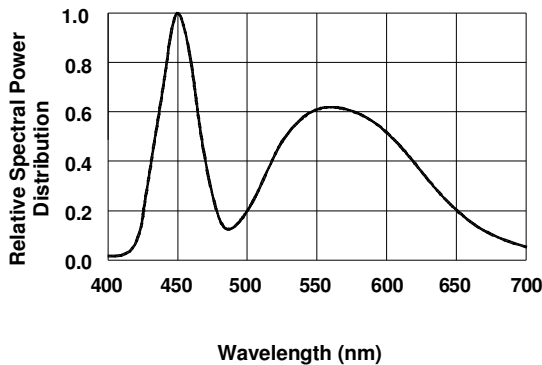
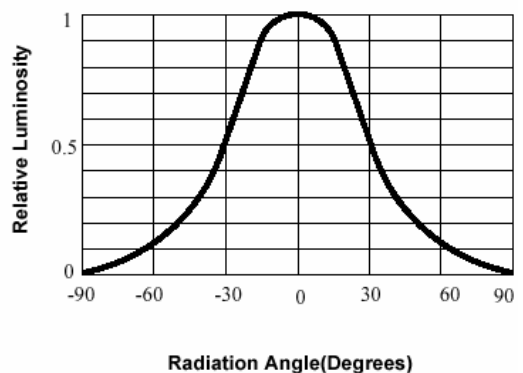

Fig 6. Relative Power vs. Radiation Angle





Model No : CSHV-NL60SWA4-A2

Reflow Soldering Characteristics

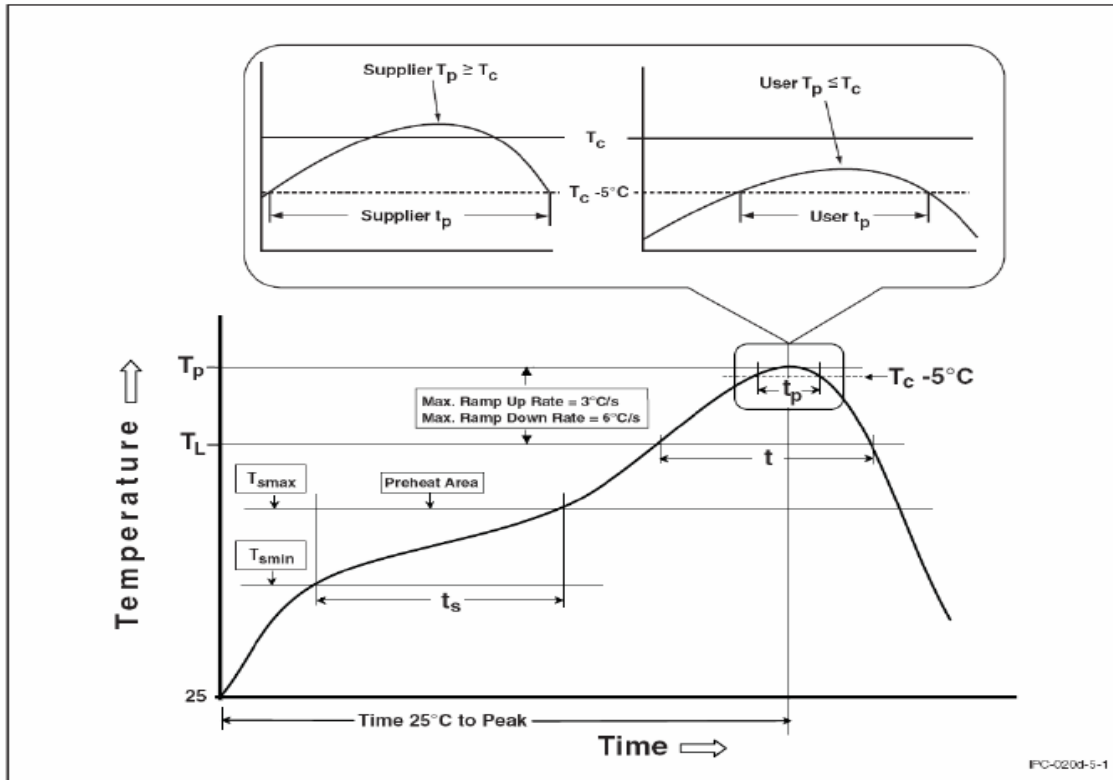

Profile Feature	Sn-Pb Eutectic Assembly	Pb-Free Assembly
Preheat & Soak		
Temperature min (T_{smin})	100 °C	150 °C
Temperature max (T_{smax})	150 °C	200 °C
Time (T_{smin} to T_{smax}) (t_s)	60-120 seconds	60-120 seconds
Average ramp-up rate (T_{smax} to T_p)	3 °C/second max.	3 °C/second max.
Liquidous temperature (T_L)	183 °C	217 °C
Time at liquidous (t_L)	60-150 seconds	60-150 seconds
Peak package body temperature (T_p)*	See classification temp in Table 4.1	See classification temp in Table 4.2
Time (t_p)** within 5 °C of the specified classification temperature (T_c)	20** seconds	30** seconds
Average ramp-down rate (T_p to T_{smax})	6 °C/second max.	6 °C/second max.
Time 25 °C to peak temperature	6 minutes max.	8 minutes max.

* Tolerance for peak profile temperature (T_p) is defined as a supplier minimum and a user maximum.
 ** Tolerance for time at peak profile temperature (t_p) is defined as a supplier minimum and a user maximum.

Hand Soldering Characteristics

Soldering temperature	260 °C
Soldering time	5 sec

Notes: All temperatures refer to Solder Pad



Spec. No.	PS-0805-007
Rev.	A

Model No : CSHV-NL60SWA4-A2

Package

- 1. Tube: 50pcs/tube
- CSC P/N: CSC Production number
- Flux: intensity grade
- Hue: wavelength grade
- Qty: quantity

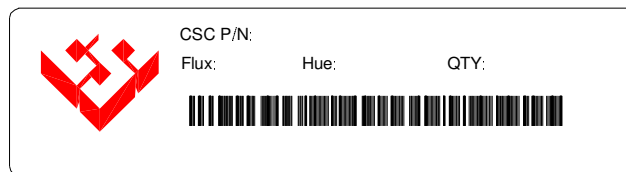
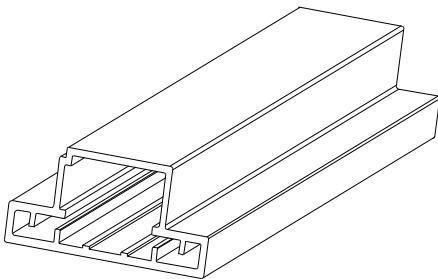

on tube

- 2. anti-electrostatic bag: 10 tubes/ bag
- Product type: Vega Power
- CSC P/N: CSC Production number
- Flux: intensity grade
- Hue: wavelength grade
- Date code: production time
- Customer P/N: customer production number
- Qty: quantity

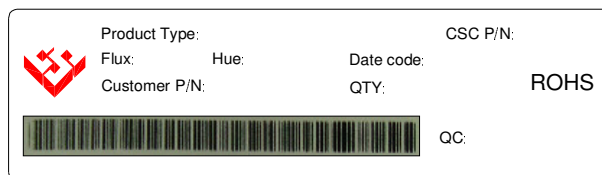
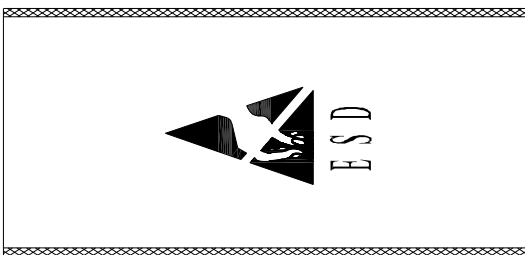

on anti-electrostatic bag

- 3. carton: 2 anti-electrostatic bags/carton
- P/N: production number
- Qty: quantity
- Date code: production time

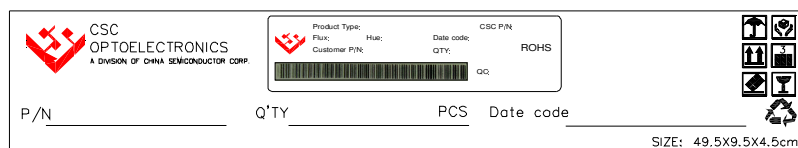
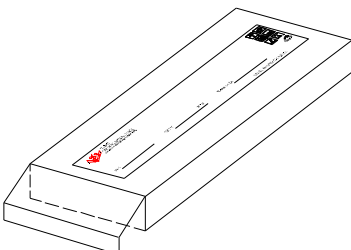

on carton



Model No : CSHV-NL60SWA4-A2

■ Precautions for use

1. Please use LEDES refer to JEDEC 2a(Industry Best Moisture Sensitivity Level) as below:

Floor life		standard		accelerated Environment	
time	conditions	time	conditions	time	conditions
4	≤ 30°C/60%RH	(hours)	30°C/60%RH	(hours)	60°C/60%RH
weeks		696 [±] 5/-0		120+1/-0	

Notes: The standard soak time includes a default value of 24 hours for semiconductor exposure time between bake and bag and includes the maximum time allowed out of bag at the distributor's facility.

2. Please confirm the moisture card in the anti-electrostatic bag after opening package.

If it shows 50%RH, LEDs should be performed baking treatment before used.

(bake condition: At 125°C +5/-0 for 24 hours)

3. Any mechanical force or any excess vibration on LENS should be avoided during operating.

4. LED should be stored below 60%RH after opening package.

5. Please refer to fig3 of page4 to choose current drive to use. Ambient temperature will affect current.

Note: The specifications are subject to change without notice. Please contact us for updated information.