

# ELM85xxxxA CMOS 800mA LDO voltage regulator

## ■ General description

ELM85xxxxA is CMOS voltage regulator which is characterized with high current and low dropout (55mV at  $I_{out}=100\text{mA}$ ). There are 2 types of CE selection of ELM85 series: non-chip enable function and “H” active. The standard output voltages are 3.0V, 3.3V, 5.0V; ELM85 series can also be made as semi-custom IC within the range of 0.8V~5.0V by 0.1V step. This series also includes short circuit current limiter and thermal shutdown circuit. Ceramic capacitors with low ESR can be used as input and output ones.

## ■ Features

- Output voltage range : 0.8V~5.0V (by 0.1V)
- Maximum output current : 800mA
- Current consumption : Typ.40 $\mu\text{A}$
- Input stability : Typ.0.02%/V
- Load stability : Typ.20mV ( $1\text{mA} \leq I_{out} \leq 300\text{mA}$ )
- Accuracy of output voltage :  $\pm 2.0\%$
- Input-output voltage difference : Typ.55mV ( $V_{out}=3.0\text{V}$ ,  $I_{out}=100\text{mA}$ )
- Short circuit current limiter : Typ.70mA ( $V_{out}=0\text{V}$ )
- Package : SOT-223 (0.8V~5.0V)  
SOT-89 (1.2V~4.0V)  
SOT-89-5 (1.2V~4.0V)  
(0.8V~1.1V, 4.1V~5.0V are available in SOT-223 package only.)

## ■ Application

- Battery operated devices
- Portable AV equipments

## ■ Maximum absolute ratings

Parameter	Symbol	Limit	Unit
Input voltage	$V_{in}$	$V_{SS}-0.3 \sim 7.0$	V
Output voltage	$V_{out}$	$V_{SS}-0.3 \sim V_{in}+0.3$	V
Output current	$I_{out}$	1000	mA
Power dissipation	$P_d$	300 (SOT-89) 500 (SOT-89-5) 625 (SOT-223)	mW
Thermal resistance junction to ambient	$R\theta_{ja}$	160 (SOT-223 ) 200 (SOT-89) 200 (SOT-89-5)	$^{\circ}\text{C}/\text{W}$
Operating temperature	$T_{op}$	-40~+85	$^{\circ}\text{C}$
Storage temperature	$T_{stg}$	-55~+125	$^{\circ}\text{C}$

## ■ Selection guide

### ELM85xxxxA-x

Symbol		
a,b	Output voltage	e.g. : 30: Vout=3.0V 33: Vout=3.3V 50: Vout=5.0V
c	CE selection	1 : NO CE 3 : CE="H" active
d	Package	H : SOT-223 A : SOT-89, SOT-89-5
e	Product version	A
f	Taping direction	S : SOT-223, SOT-89, SOT-89-5 N : SOT-89, SOT-89-5 Refer to PKG file

ELM85 x x x x A - x  
 ↑ ↑ ↑ ↑ ↑ ↑  
 a b c d e f

## ■ Pin configuration

SOT-223 (TOP VIEW)

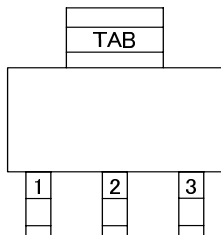

ELM85xx1HA

Pin No.	Pin name
1	VSS
2/TAB	VIN
3	VOUT

SOT-89 (TOP VIEW)

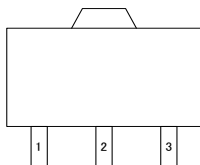

ELM85xx1AA

Pin No.	Pin name
1	VSS
2	VIN
3	VOUT

SOT-89-5 (TOP VIEW)

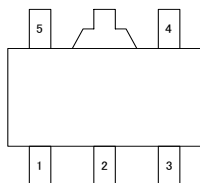

ELM85xx3AA

Pin No.	Pin name
1	VSS
2	VIN
3	VOUT
4	NC
5	CE

# ELM85xxxxA CMOS 800mA LDO voltage regulator

## Standard circuit

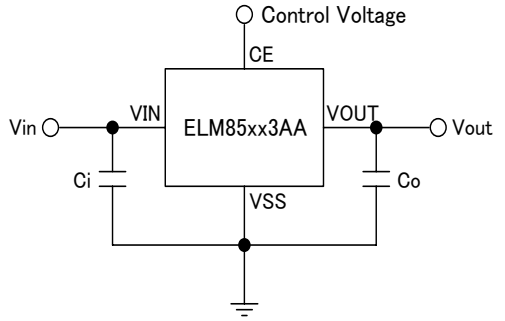
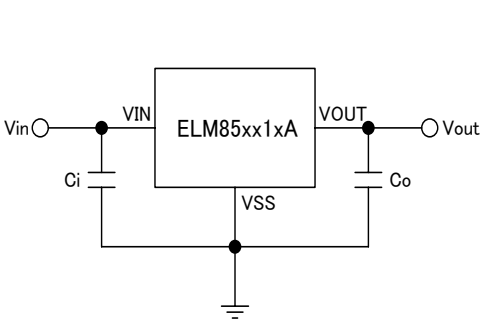

## Block diagram

ELM85xx1xA

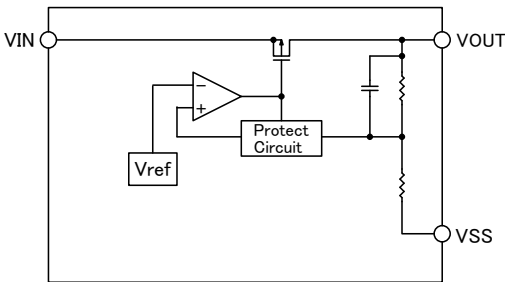

ELM85xx3AA

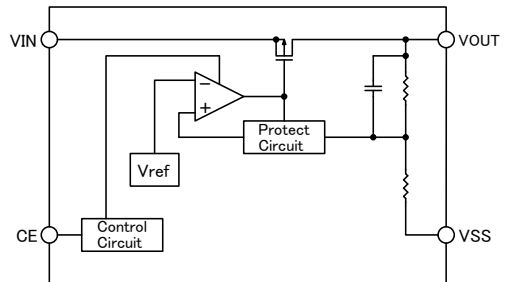

## Electrical characteristics (ELM85xx1xA)

$V_{out}=3.0V$  (ELM85301xA), No CE pin

$C_i=1.0\mu F$ ,  $C_o=4.7\mu F$ ,  $T_{op}=25^\circ C$

Parameter	Symbol	Condition	Min.	Typ.	Max.	Unit
Output voltage	$V_{out}$	$V_{in}=4.0V$ , $I_{out}=40mA$	2.940	3.000	3.060	V
Output current	$I_{out}$	$V_{in}=4.0V$	800			mA
Input stability	$\Delta V_{out}/\Delta V_{in}$	$3.5V \leq V_{in} \leq 6.0V$ , $I_{out}=100mA$		0.02	0.20	%/V
Load stability	$\Delta V_{out}/\Delta I_{out}$	$V_{in}=4.0V$ , $1mA \leq I_{out} \leq 300mA$		20	60	mV
Input-Output voltage differential	$V_{dif}$	$I_{out}=100mA$		55	90	mV
Current consumption	$I_{ss}$	$V_{in}=4.0V$		40	100	$\mu A$
Input voltage	$V_{in}$		1.4		6.0	V
Output voltage temperature coefficient	$\Delta V_{out}/\Delta T_{op}$	$-40^\circ C \leq T_{op} \leq +85^\circ C$ , $V_{in}=4.0V$ , $I_{out}=40mA$		$\pm 100$		ppm/ $^\circ C$
Short circuit current	$I_{lim}$	$V_{out}=0V$		70		mA
Ripple rejection ratio	RR	$f=1kHz$ , $I_{out}=40mA$		60		dB
Thermal shutdown temperature	$T_{sd}$			165		$^\circ C$
Output noise	$V_{no}$	$BW=10Hz \sim 100kHz$		30		$\mu V_{rms}$

# ELM85xxxxA CMOS 800mA LDO voltage regulator

Vout=3.3V (ELM85331xA), No CE pin

Ci=1.0  $\mu$ F, Co=4.7  $\mu$ F, Top=25°C

Parameter	Symbol	Condition	Min.	Typ.	Max.	Unit
Output voltage	Vout	Vin=4.3V, Iout=40mA	3.234	3.300	3.366	V
Output current	Iout	Vin=4.3V	800			mA
Input stability	$\Delta V_{out}/\Delta V_{in}$	$3.8V \leq V_{in} \leq 6.0V$ , Iout=100mA		0.02	0.20	%/V
Load stability	$\Delta V_{out}/\Delta I_{out}$	Vin=4.3V, $1mA \leq I_{out} \leq 300mA$		20	60	mV
Input-Output voltage differential	Vdif	Iout=100mA		55	90	mV
Current consumption	I <sub>ss</sub>	Vin=4.3V		40	100	$\mu$ A
Input voltage	Vin		1.4		6.0	V
Output voltage temperature coefficient	$\Delta V_{out}/\Delta T_{op}$	$-40^{\circ}C \leq T_{op} \leq +85^{\circ}C$ , Vin=4.3V, Iout=40mA		$\pm 100$		ppm/°C
Short circuit current	I <sub>lim</sub>	Vout=0V		70		mA
Ripple rejection ratio	RR	f=1kHz, Iout=40mA		60		dB
Thermal shutdown temperature	Tsd			165		°C
Output noise	Vno	BW=10Hz ~ 100kHz		30		$\mu$ Vrms

Vout=5.0V (ELM85501HA), No CE pin

Ci=1.0  $\mu$ F, Co=4.7  $\mu$ F, Top=25°C

Parameter	Symbol	Condition	Min.	Typ.	Max.	Unit
Output voltage	Vout	Vin=6.0V, Iout=40mA	4.900	5.000	5.100	V
Output current	Iout	Vin=6.0V	800			mA
Input stability	$\Delta V_{out}/\Delta V_{in}$	$5.5V \leq V_{in} \leq 6.0V$ , Iout=100mA		0.02	0.20	%/V
Load stability	$\Delta V_{out}/\Delta I_{out}$	Vin=6.0V, $1mA \leq I_{out} \leq 300mA$		20	60	mV
Input-Output voltage differential	Vdif	Iout=100mA		52	85	mV
Current consumption	I <sub>ss</sub>	Vin=6.0V		40	100	$\mu$ A
Input voltage	Vin		1.4		6.0	V
Output voltage temperature coefficient	$\Delta V_{out}/\Delta T_{op}$	$-40^{\circ}C \leq T_{op} \leq +85^{\circ}C$ , Vin=6.0V, Iout=40mA		$\pm 100$		ppm/°C
Short circuit current	I <sub>lim</sub>	Vout=0V		70		mA
Ripple rejection ratio	RR	f=1kHz, Iout=40mA		60		dB
Thermal shutdown temperature	Tsd			165		°C
Output noise	Vno	BW=10Hz ~ 100kHz		30		$\mu$ Vrms

\* ELM8550 is available in only SOT-223 package.

# ELM85xxxxA CMOS 800mA LDO voltage regulator

## ■ Electrical characteristics (ELM85xx3AA)

Vout=3.0V (ELM85303AA), CE="H" active

Ci=1.0 μF, Co=4.7 μF, Top=25°C

Parameter	Symbol	Condition	Min.	Typ.	Max.	Unit
Output voltage	Vout	Vin=4.0V, Iout=40mA	2.940	3.000	3.060	V
Output current	Iout	Vin=4.0V	800			mA
Input stability	$\Delta V_{out}/\Delta V_{in}$	$3.5V \leq V_{in} \leq 6.0V$ , Iout=100mA		0.02	0.20	%/V
Load stability	$\Delta V_{out}/\Delta I_{out}$	Vin=4.0V, 1mA ≤ Iout ≤ 300mA		20	60	mV
Input-Output voltage differential	Vdif	Iout=100mA		55	90	mV
Current consumption	Iss	Vin=4.0V		40	100	μA
Standby current consumption	Istandby	Vin=4.0V, Vce=0V			0.5	μA
Input voltage	Vin		1.4		6.0	V
CE input voltage High	Vceh	Vin=6.0V	1.8		Vin	V
CE input voltage Low	Vcel	Vin=1.4V	0.0		0.2	V
CE input current High	Iceh	Vce=Vin=6.0V	-0.2		0.2	μA
CE input current Low	Icel	Vce=Vss, Vin=6.0V	-0.2		0.2	μA
Output voltage temperature coefficient	$\Delta V_{out}/\Delta T_{top}$	-40°C ≤ Top ≤ +85°C, Vin=4.0V, Iout=40mA		± 100		ppm/°C
Short circuit current	Ilim	Vout=0V		70		mA
Ripple rejection ratio	RR	f=1kHz, Iout=40mA		60		dB
Thermal shutdown temperature	Tsd			165		°C
Output noise	Vno	BW=10Hz ~ 100kHz		30		μVrms

Vout=3.3V (ELM85333AA), CE="H" active

Ci=1.0 μF, Co=4.7 μF, Top=25°C

Parameter	Symbol	Condition	Min.	Typ.	Max.	Unit
Output voltage	Vout	Vin=4.3V, Iout=40mA	3.234	3.300	3.366	V
Output current	Iout	Vin=4.3V	800			mA
Input stability	$\Delta V_{out}/\Delta V_{in}$	$3.8V \leq V_{in} \leq 6.0V$ , Iout=100mA		0.02	0.20	%/V
Load stability	$\Delta V_{out}/\Delta I_{out}$	Vin=4.3V, 1mA ≤ Iout ≤ 300mA		20	60	mV
Input-Output voltage differential	Vdif	Iout=100mA		55	90	mV
Current consumption	Iss	Vin=4.3V		40	100	μA
Standby current consumption	Istandby	Vin=4.3V, Vce=0V			0.5	μA
Input voltage	Vin		1.4		6.0	V
CE input voltage High	Vceh	Vin=6.0V	1.8		Vin	V
CE input voltage Low	Vcel	Vin=1.4V	0.0		0.2	V
CE input current High	Iceh	Vce=Vin=6.0V	-0.2		0.2	μA
CE input current Low	Icel	Vce=Vss, Vin=6.0V	-0.2		0.2	μA
Output voltage temperature coefficient	$\Delta V_{out}/\Delta T_{top}$	-40°C ≤ Top ≤ +85°C, Vin=4.3V, Iout=40mA		± 100		ppm/°C
Short circuit current	Ilim	Vout=0V		70		mA
Ripple rejection ratio	RR	f=1kHz, Iout=40mA		60		dB
Thermal shutdown temperature	Tsd			165		°C
Output noise	Vno	BW=10Hz ~ 100kHz		30		μVrms

# ELM85xxxxA CMOS 800mA LDO voltage regulator

## ■ Marking

- SOT-223 package : ELM85xx1HA

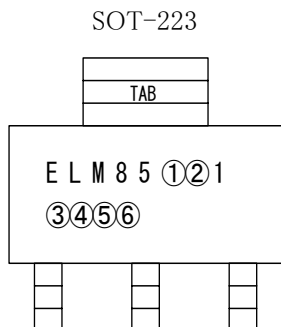

No. ① , ② : Output voltage. e.g. : 33 (Vout=3.3V)  
③ : Product version  
④~⑥ : Assembly lot No.  
A~Z (I, O, X excepted) and 0~9

- SOT-89 package : ELM85xx1AA

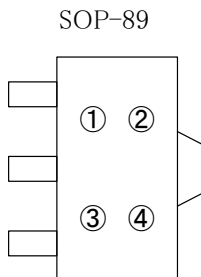

No. ①~④ : Assembly lot No.  
A~Z (I, O, X excepted) and 0~9

- SOT-89-5 package : ELM85xx3AA with CE

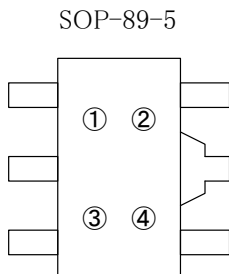

No. ①~④ : Assembly lot No.  
A~Z (I, O, X excepted) and 0~9

## ■ Typical characteristics

- 3.0V  $V_{out}$  unit (ELM8530xxA)

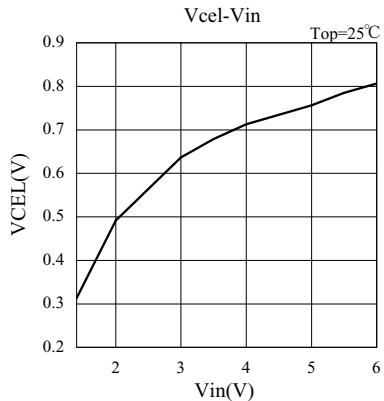
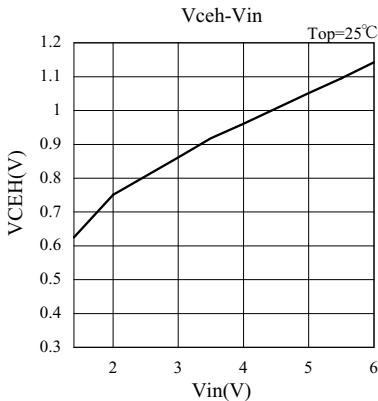
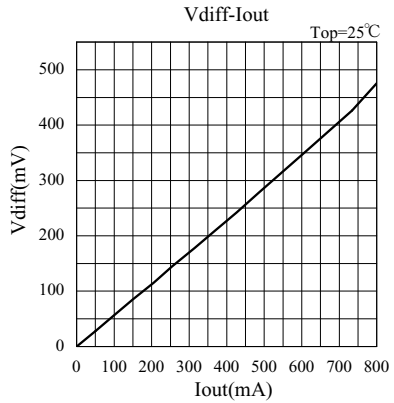
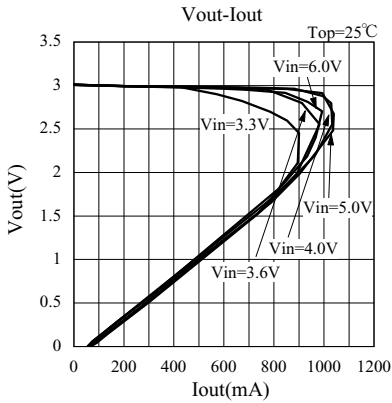
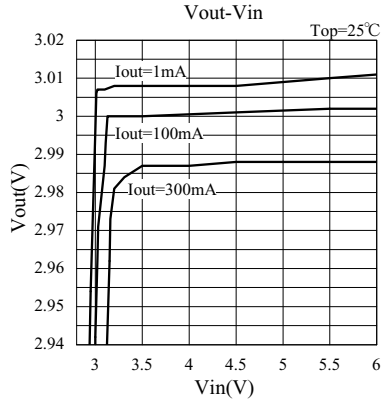
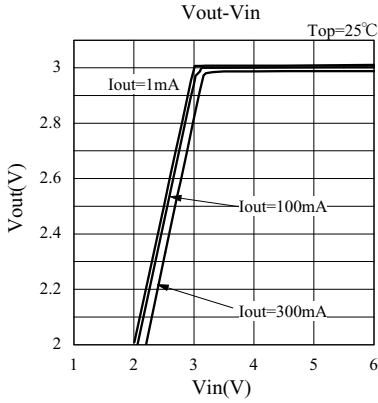

# ELM85xxxxA CMOS 800mA LDO voltage regulator

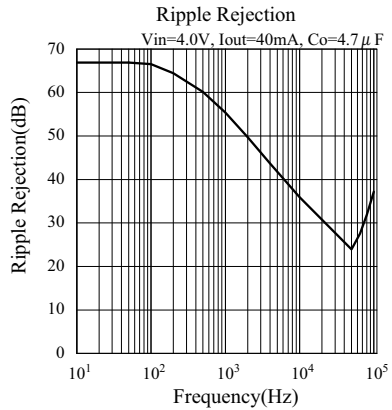
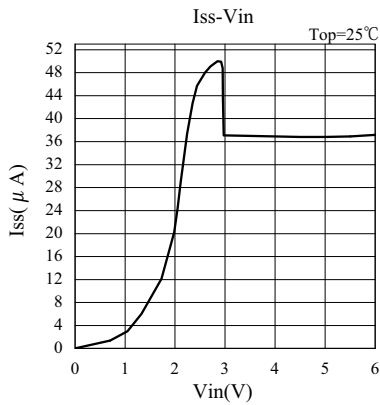
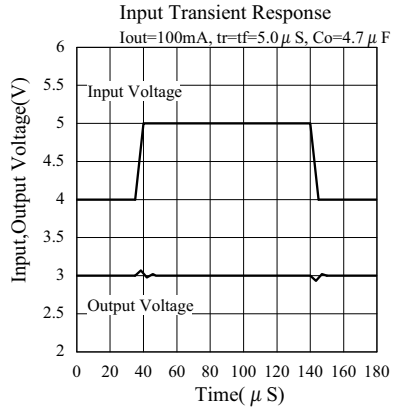
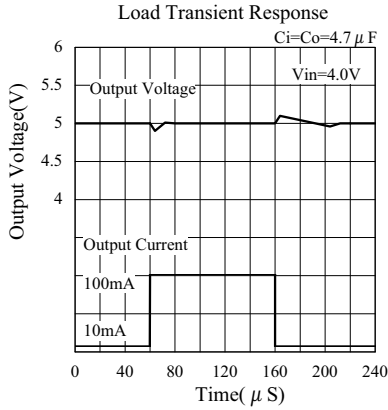



- 3.3V Vout unit (ELM8533xxA)

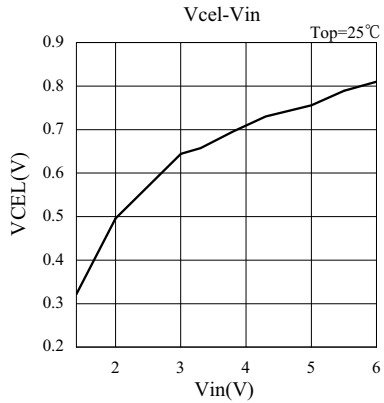
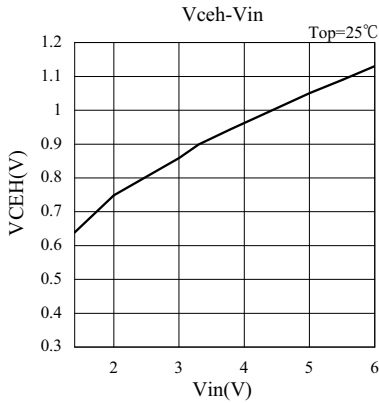
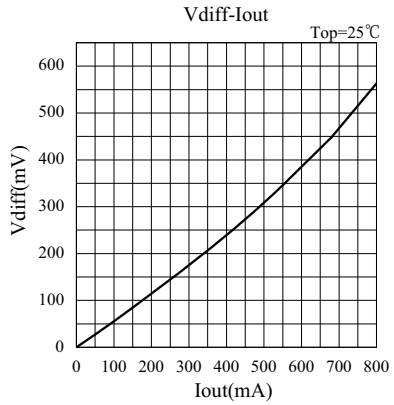
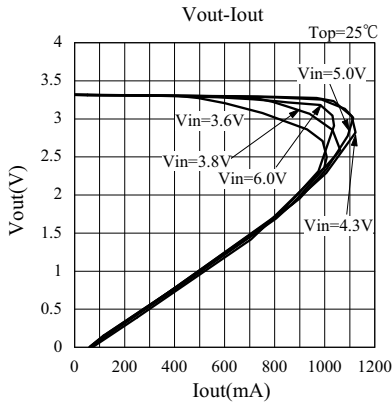
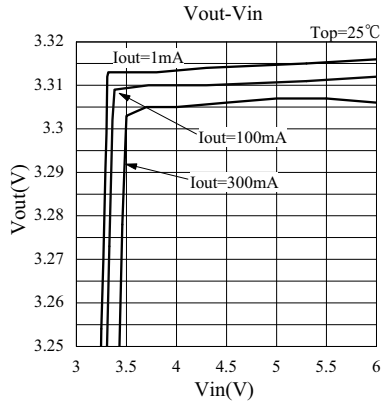
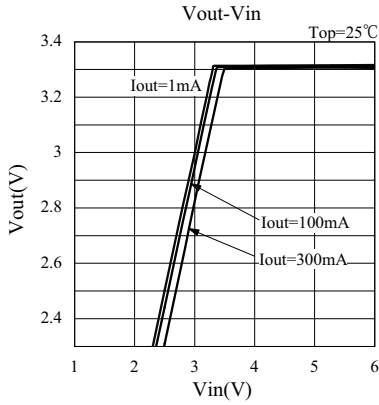

# ELM85xxxxA CMOS 800mA LDO voltage regulator

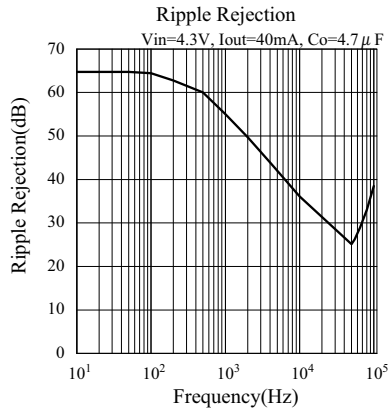
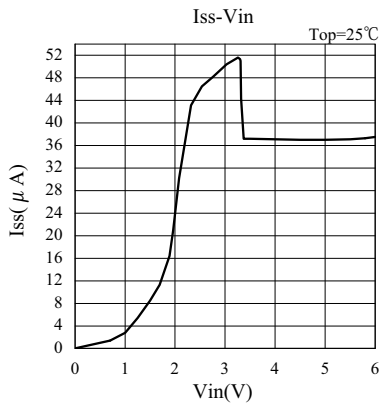
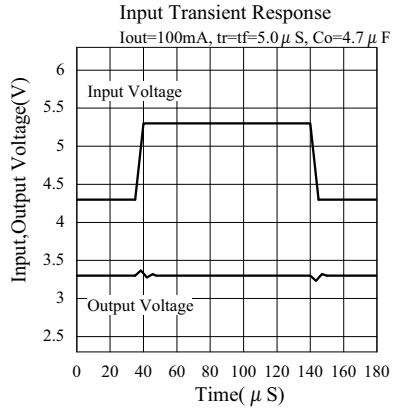
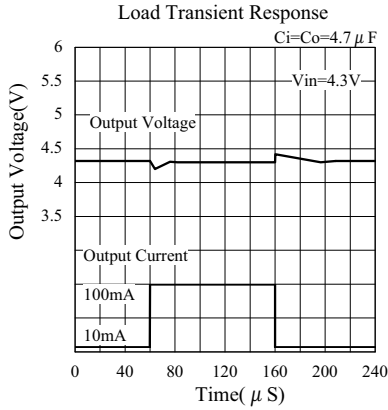

- 5.0V Vout unit (ELM85501HA)

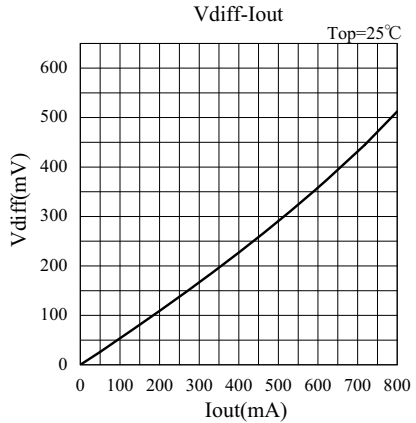
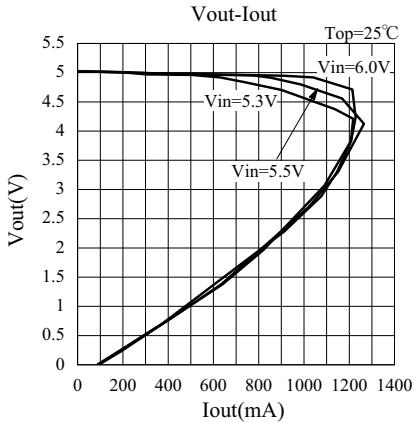
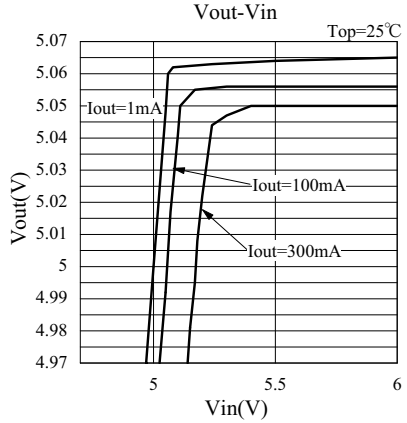
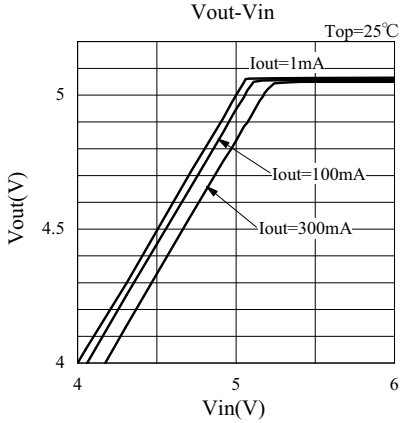

# ELM85xxxxA CMOS 800mA LDO voltage regulator

