

## PWM Off-Line Switching Regulator ICs

### Features and Benefits

- Current mode PWM control
- Brown-In and Brown-Out function: auto-restart, prevents excess input current and heat rise at low input voltage
- Auto Standby function: improves efficiency by Burst mode operation in light load
  - Normal load operation: PWM mode
  - Light load operation: Burst mode
- No load power consumption < 25 mW
- Operating frequency,  $f_{OSC(AVG)}(typ) = 67\text{ kHz}$
- Random Switching function: reduces EMI noise, and simplifies EMI filters
- Slope Compensation function: avoids subharmonic oscillation
- Leading Edge Blanking function

Continued on the next page...

Package: DIP8



Not to scale

### Description

The STR-A6051M, STR-A6052M, STR-A6053M, and STR-A6079M are power ICs for switching power supplies, incorporating a power MOSFET and a current mode PWM controller IC in one package.

To achieve low power consumption, these products include a startup circuit and a standby function in the controller. The switching modes are automatically changed according to load conditions: in normal operation, PWM mode, and in light load conditions, burst mode. The rich set of protection features helps to realize low component counts, and high performance-to-cost power supply.

### Applications:

Switching power supplies for electronic devices such as:

- Battery charger
- Standby power supply
- Small switch-mode power supply (SMPS)
- Auxiliary power supply for controller

### Typical Application Circuit

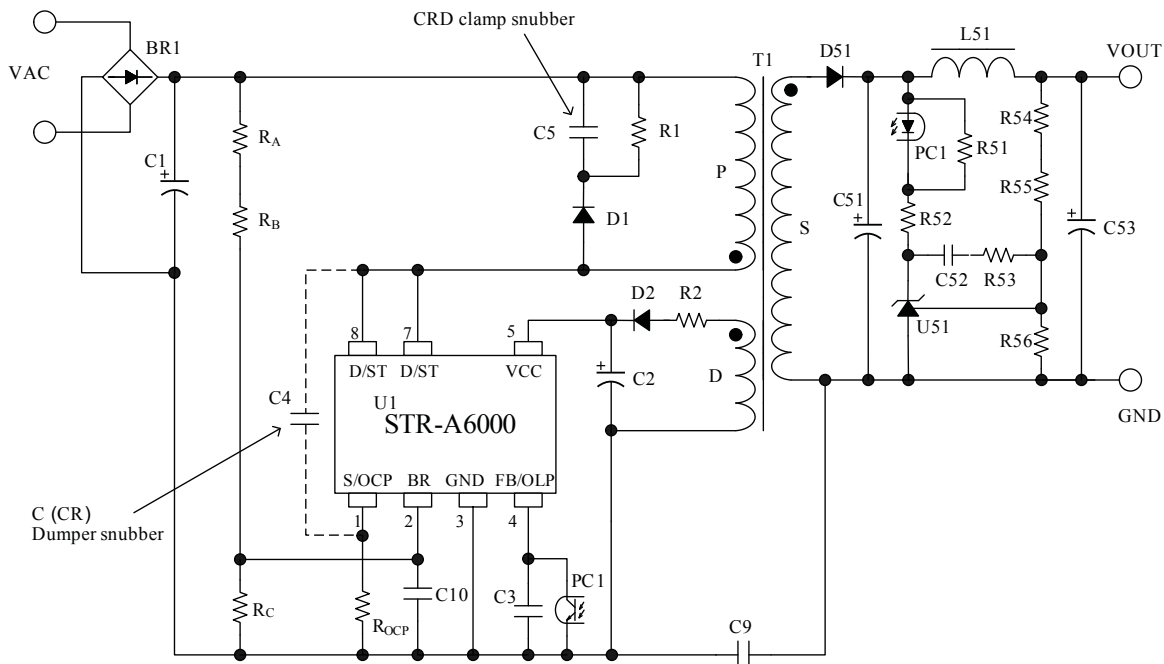

**Features and Benefits (continued)**

- Audible Noise Suppression function during Standby mode
- Protection features
  - Overcurrent protection (OCP): pulse-by-pulse, with input compensation function
  - Overvoltage protection (OVP): latched shutdown
  - Overload protection (OLP): auto-restart, with timer
  - Thermal shutdown protection (TSD): latched shutdown

**Selection Guide**

Part Number	Power MOSFET		Output Power*, P <sub>OUT</sub> (W)			
	V <sub>DSS(min)</sub> (V)	R <sub>DS(ON)(max)</sub> (Ω)	Open Frame		Adaptor	
			230 VAC	85 to 265 VAC	230 VAC	85 to 265 VAC
STR-A6051M	650	3.95	30	21	20	16
STR-A6052M	650	2.8	35	25	23	19
STR-A6053M	650	1.9	41	29	26	22
STR-A6079M	800	19.2	13	9	8	6

\*The listed output power is based on the thermal ratings, and the peak output power can be 120% to 140% of the value stated here. At low output voltage and short duty cycle, the output power may be less than the value stated here.

The polarity value for current specifies a sink as "+," and a source as "–," referencing the IC.

**Absolute Maximum Ratings** Unless otherwise specified, T<sub>A</sub> = 25°C

Characteristic	Symbol	Notes	Pins	Rating	Unit		
Drain Peak Current <sup>1</sup>	I <sub>DPEAK</sub>	STR-A6051M	Single pulse	8 – 1	2.5	A	
		STR-A6052M			3.0	A	
		STR-A6053M			4.0	A	
		STR-A6079M			1.2	A	
Avalanche Energy <sup>2</sup>	E <sub>AS</sub>	STR-A6051M	Single pulse, V <sub>DD</sub> = 99 V, L = 20 mH, I <sub>LPEAK</sub> = 2 A	8 – 1	47	mJ	
		STR-A6052M			Single pulse, V <sub>DD</sub> = 99 V, L = 20 mH, I <sub>LPEAK</sub> = 2.3 A	62	mJ
		STR-A6053M			Single pulse, V <sub>DD</sub> = 99 V, L = 20 mH, I <sub>LPEAK</sub> = 2.7 A	86	mJ
		STR-A6079M			Single pulse, V <sub>DD</sub> = 99 V, L = 20 mH, I <sub>LPEAK</sub> = 1.2 A	7	mJ
S/OCP Pin Voltage	V <sub>OCP</sub>		1 – 3	–2 to 6	V		
Control Part Input Voltage	V <sub>CC</sub>		5 – 3	32	V		
FB/OLP Pin Voltage	V <sub>FB</sub>		4 – 3	–0.3 to 14	V		
FB/OLP Pin Sink Current	I <sub>FB</sub>		4 – 3	1.0	mA		
BR Pin Voltage	V <sub>BR</sub>		2 – 3	–0.3 to 7	V		
BR Pin Sink Current	I <sub>BR</sub>		2 – 3	1.0	mA		
Power Dissipation of MOSFET <sup>3</sup>	P <sub>D1</sub>	Mounted on 15 mm × 15 mm printed circuit board	8 – 1	1.35	W		
Power Dissipation of Control Part	P <sub>D2</sub>		5 – 3	1.2	W		
Operating Ambient Temperature <sup>4</sup>	T <sub>OP</sub>		–	–20 to 125	°C		
Storage Temperature	T <sub>stg</sub>		–	–40 to 125	°C		
Channel Temperature	T <sub>ch</sub>		–	150	°C		

<sup>1</sup>Refer to MOSFET Safe Operating Area Curve.

<sup>2</sup>Refer to MOSFET Avalanche Energy Derating Coefficient Curve.

<sup>3</sup>Refer to MOSFET Temperature versus Power Dissipation Curve.

<sup>4</sup>The recommended internal frame temperature, T<sub>F</sub>, is 115°C (max).

**Electrical Characteristics of Control Part** Unless otherwise specified,  $T_A = 25^\circ\text{C}$ ,  $V_{CC} = 18\text{ V}$

Characteristic	Symbol	Test Conditions	Pins	Min.	Typ.	Max.	Unit
Operation Start Voltage	$V_{CC(ON)}$		5 - 3	13.8	15.3	16.8	V
Operation Stop Voltage <sup>1</sup>	$V_{CC(OFF)}$		5 - 3	7.3	8.1	8.9	V
Circuit Current in Operation	$I_{CC(ON)}$	$V_{CC} = 12\text{ V}$	5 - 3	–	–	2.5	mA
Minimum Start Voltage	$V_{ST(ON)}$		5 - 3	–	38	–	V
Startup Current	$I_{STARTUP}$	$V_{CC} = 13.5\text{ V}$	5 - 3	-3.7	-2.5	-1.5	mA
Startup Current Threshold Biasing Voltage <sup>1</sup>	$V_{CC(BIAS)}$	$I_{CC} = -100\ \mu\text{A}$	5 - 3	8.5	9.5	10.5	V
Average Operation Frequency	$f_{OSC(AVG)}$		8 - 3	60	67	74	kHz
Frequency Modulation Deviation	$\Delta f$		8 - 3	–	5	–	kHz
Maximum Duty Cycle	$D_{MAX}$		8 - 3	77	83	89	%
Minimum On-Time	$t_{ON(MIN)}$		–	–	540	–	ns
Leading Edge Blanking Time	$t_{BW}$		–	–	340	–	ns
OCP Compensation Coefficient	DPC		–	–	20	–	mV/ $\mu\text{s}$
OCP Compensation Duty Cycle Limit	$D_{DPC}$		–	–	36	–	%
OCP Threshold Voltage at Zero Duty Cycle	$V_{OCP(L)}$		1 - 3	0.70	0.78	0.86	V
OCP Threshold Voltage at 36% Duty Cycle	$V_{OCP(H)}$	$V_{CC} = 32\text{ V}$	1 - 3	0.81	0.9	0.99	V
Maximum Feedback Current	$I_{FB(MAX)}$	$V_{CC} = 12\text{ V}$	4 - 3	-340	-230	-150	$\mu\text{A}$
Minimum Feedback Current	$I_{FB(MIN)}$		4 - 3	-30	-15	-7	$\mu\text{A}$
FB/OLP Pin Oscillation Stop Threshold Voltage	$V_{FB(STB)}$		4 - 3	0.85	0.95	1.05	V
OLP Threshold Voltage	$V_{FB(OLP)}$		4 - 3	7.3	8.1	8.9	V
OLP Delay Time	$t_{OLP}$		4 - 3	54	68	82	ms
OLP Operation Current	$I_{CC(OLP)}$	$V_{CC} = 12\text{ V}$	5 - 3	–	300	600	$\mu\text{A}$
FB/OLP Pin Clamp Voltage	$V_{FB(CLAMP)}$		4 - 3	11	12.8	14	V
Brown-In Threshold Voltage	$V_{BR(IN)}$	$V_{CC} = 32\text{ V}$	2 - 3	5.2	5.6	6	V
Brown-Out Threshold Voltage	$V_{BR(OUT)}$	$V_{CC} = 32\text{ V}$	2 - 3	4.45	4.8	5.15	V
BR Pin Clamp Voltage	$V_{BR(CLAMP)}$	$V_{CC} = 32\text{ V}$	2 - 3	6	6.4	7	V
BR Function Disabling Threshold Voltage	$V_{BR(DIS)}$	$V_{CC} = 32\text{ V}$	2 - 3	0.3	0.48	0.7	V
VCC Pin OVP Threshold Voltage	$V_{CC(OVP)}$		5 - 3	26	29	32	V
Latch Circuits Holding Current <sup>2</sup>	$I_{CC(LATCH)}$	$V_{CC} = 9.5\text{ V}$	5 - 3	–	700	–	$\mu\text{A}$
Thermal Shutdown Temperature	$T_{J(TSD)}$		–	135	–	–	$^\circ\text{C}$

<sup>1</sup> $V_{CC(BIAS)} > V_{CC(OFF)}$  always.

<sup>2</sup>A latch circuit is a circuit operated with Overvoltage Protection (OVP) and/or Thermal Shutdown Protection (TSD) in operation.

**Electrical Characteristics of MOSFET** Unless otherwise specified,  $T_A$  is 25°C

Characteristic	Symbol	Test Conditions	Pins	Min.	Typ.	Max.	Unit
Drain-to-Source Breakdown Voltage	$V_{DSS}$	STR-A6051M	8 – 1	650	–	–	V
		STR-A6052M					
		STR-A6053M		800	–	–	V
		STR-A6079M					
Drain Leakage Current	$I_{DSS}$		8 – 1	–	–	300	$\mu$ A
On-Resistance	$R_{DS(ON)}$	STR-A6051M	8 – 1	–	–	3.95	$\Omega$
		STR-A6052M		–	–	2.8	$\Omega$
		STR-A6053M		–	–	1.9	$\Omega$
		STR-A6079M		–	–	19.2	$\Omega$
Switching Time	$t_f$	STR-A6051M	8 – 1	–	–	250	ns
		STR-A6052M					
		STR-A6053M		–	–	400	ns
		STR-A6079M					
Thermal Resistance	$R_{\theta ch-C}$	The thermal resistance between the channels of the MOSFET and the case. Case temperature, $T_C$ , is measured at the center of the case top surface.	–	–	–	22	$^{\circ}$ C/W

**Characteristic Performance  
STR-A6051M**

**S. O. A. Temperature Derating Coefficient Curve**

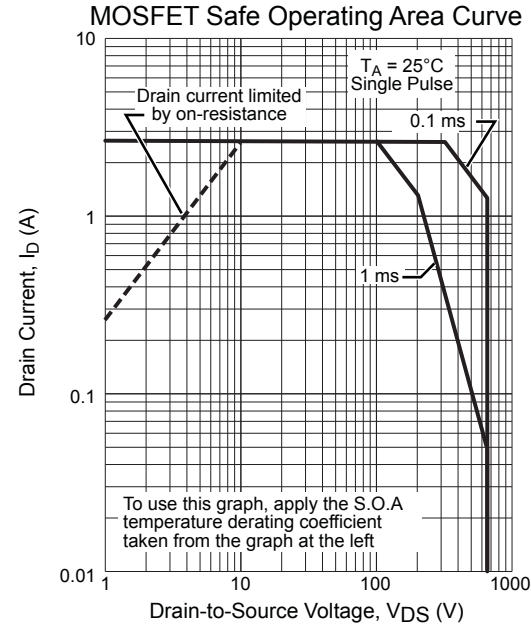
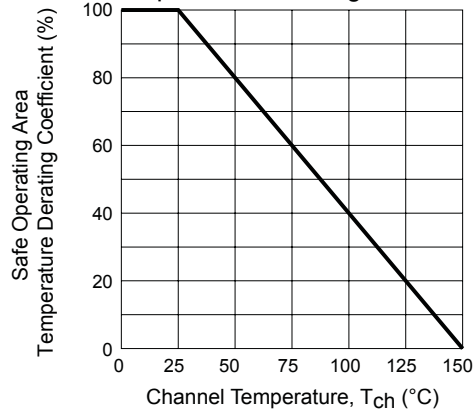

**MOSFET Avalanche Energy Derating Coefficient Curve**

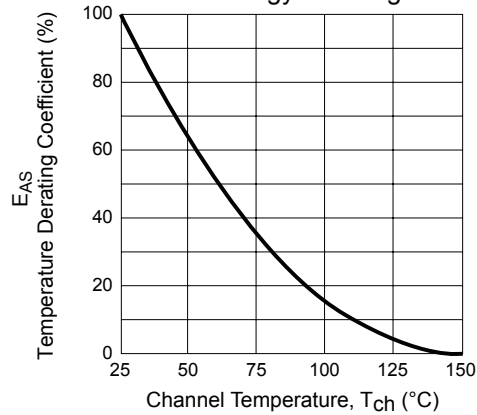

**MOSFET Temperature versus Power Dissipation Curve**

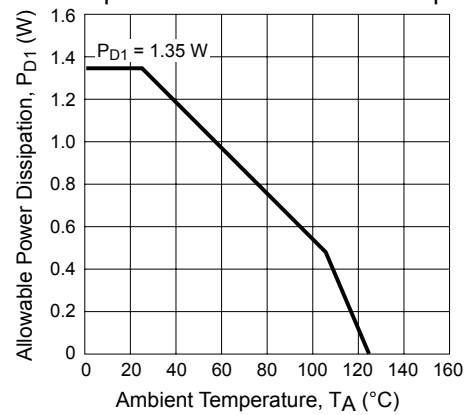

**Transient Thermal Resistance Curve**

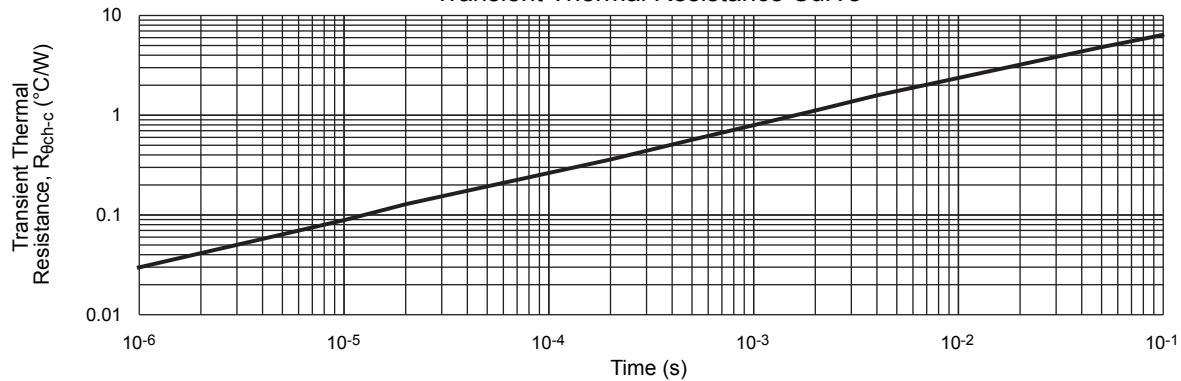

**Characteristic Performance  
STR-A6052M**

**S. O. A. Temperature Derating Coefficient Curve**

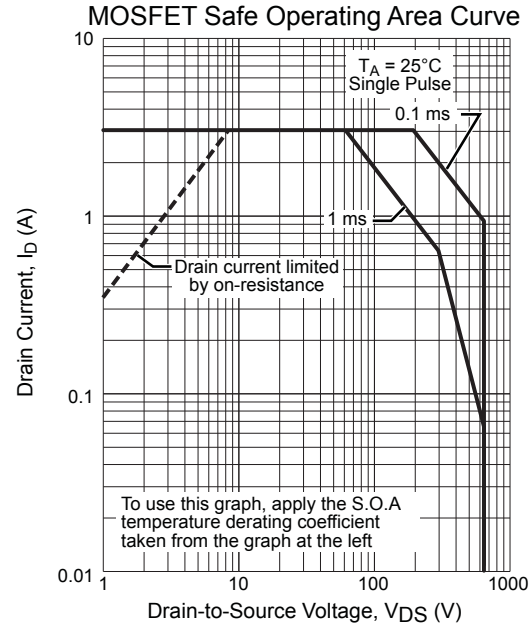
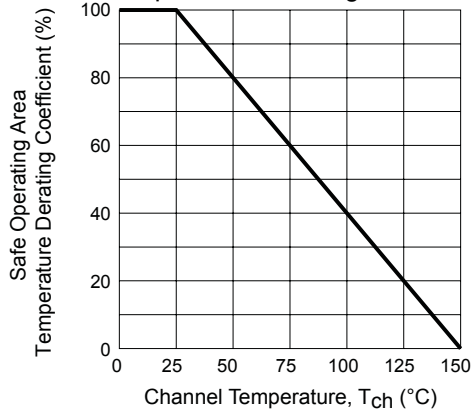

**MOSFET Avalanche Energy Derating Coefficient Curve**

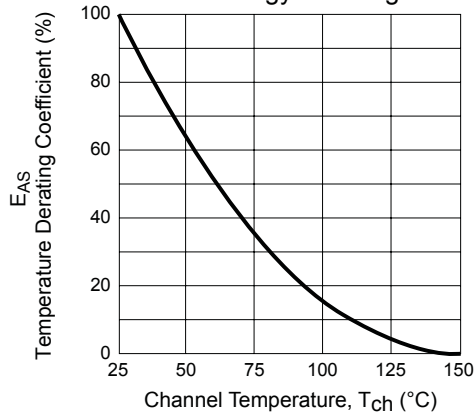

**MOSFET Temperature versus Power Dissipation Curve**

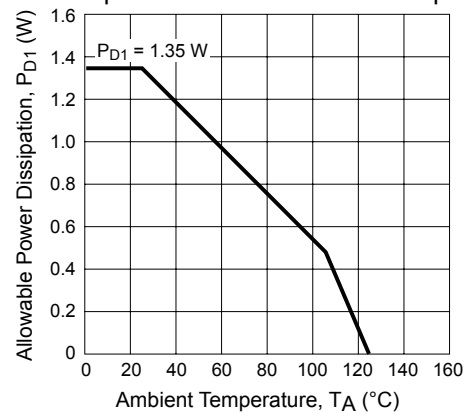

**Transient Thermal Resistance Curve**

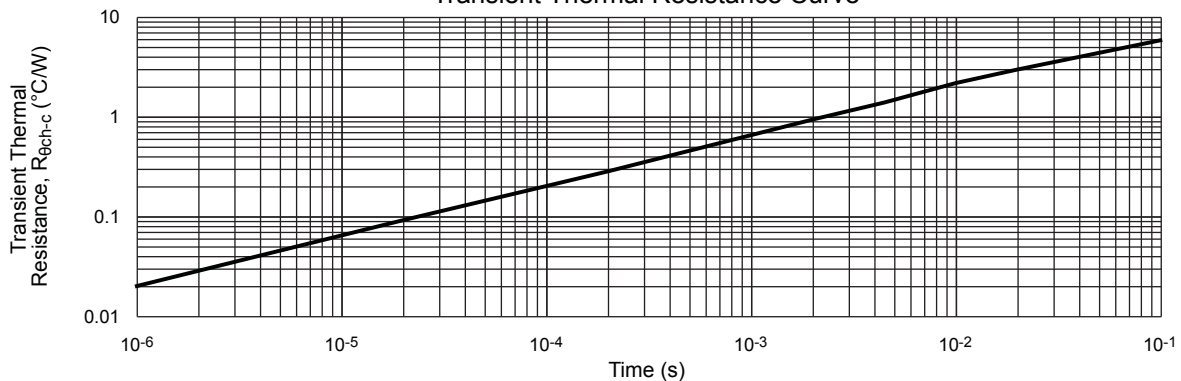

**Characteristic Performance  
STR-A6053M**

**S. O. A. Temperature Derating Coefficient Curve**

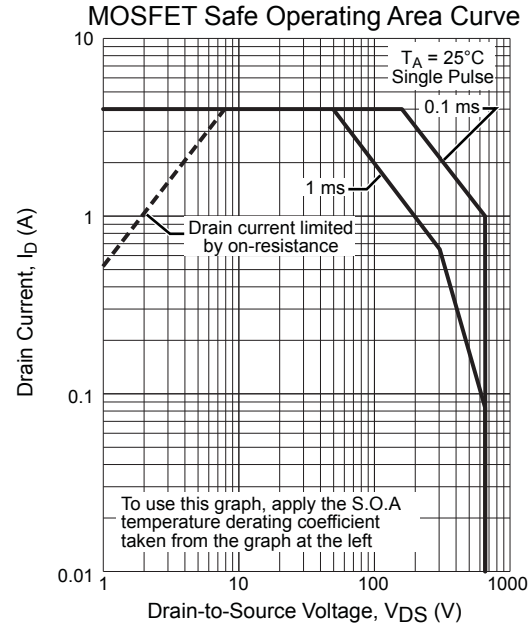
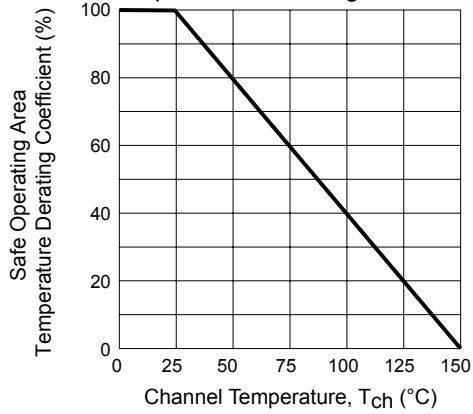

**MOSFET Avalanche Energy Derating Coefficient Curve**

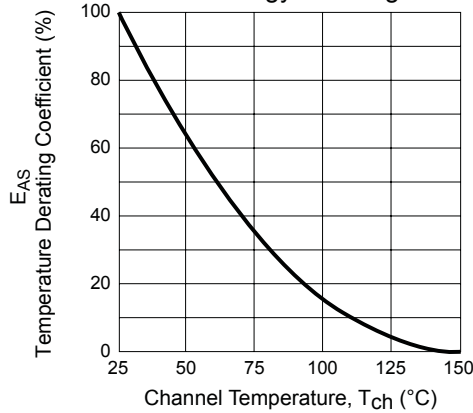

**MOSFET Temperature versus Power Dissipation Curve**

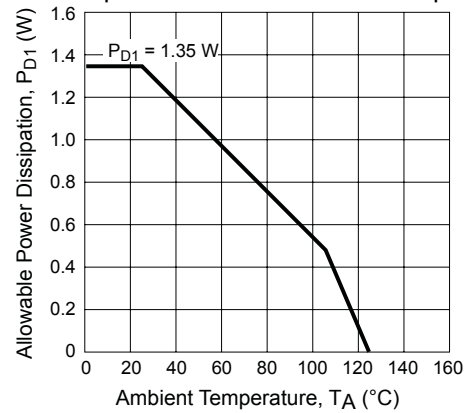

**Transient Thermal Resistance Curve**

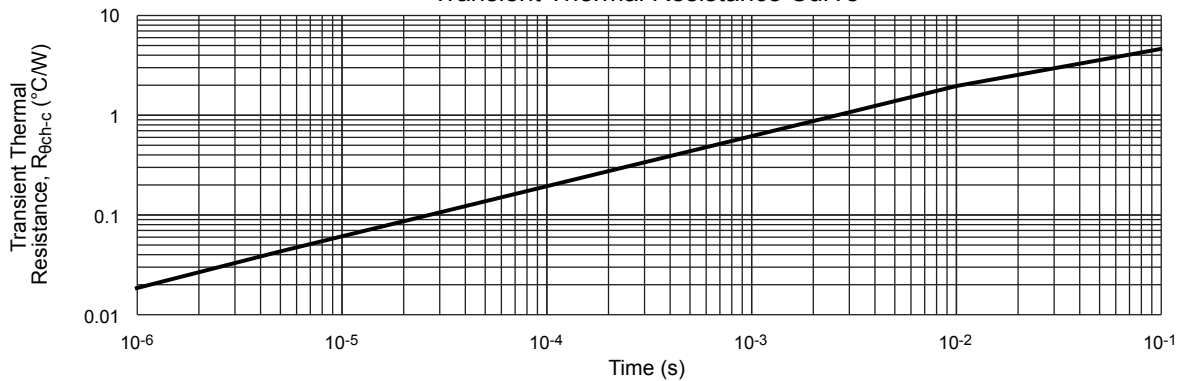

**Characteristic Performance  
STR-A6079M**

**S. O. A. Temperature Derating Coefficient Curve**

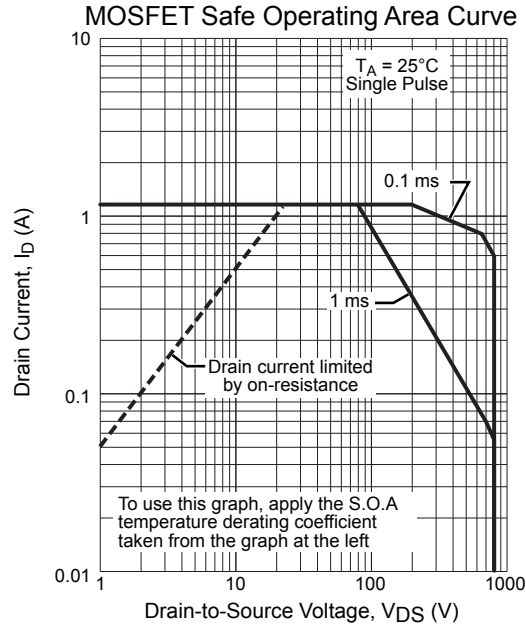
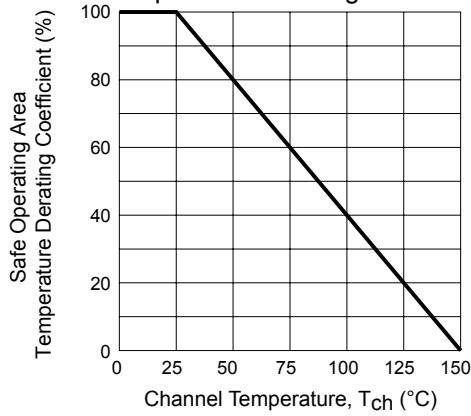

**MOSFET Avalanche Energy Derating Coefficient Curve**

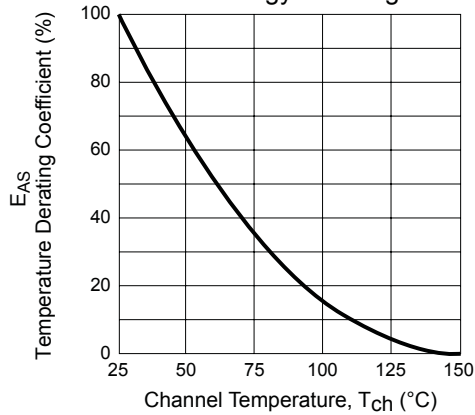

**MOSFET Temperature versus Power Dissipation Curve**

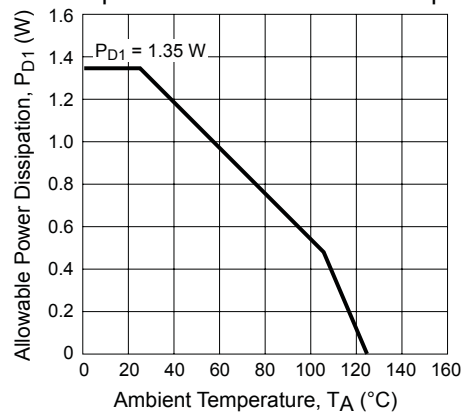

**Transient Thermal Resistance Curve**

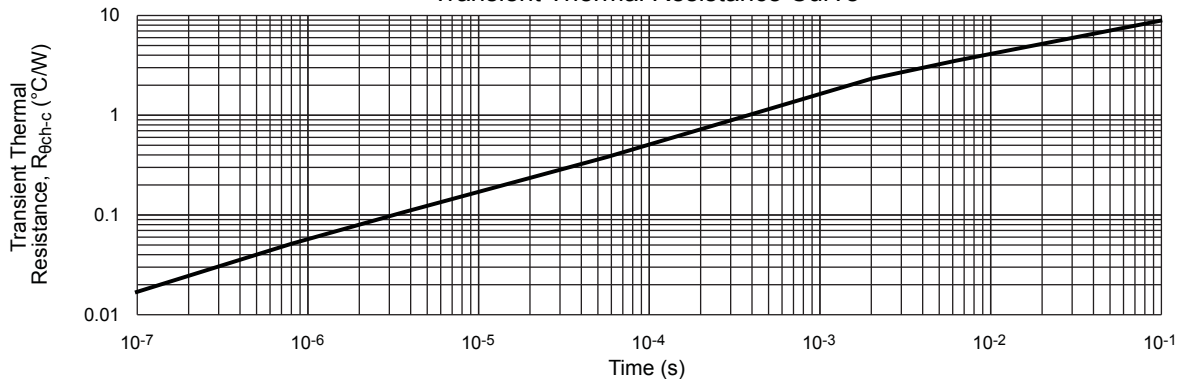



**Functional Block Diagram**

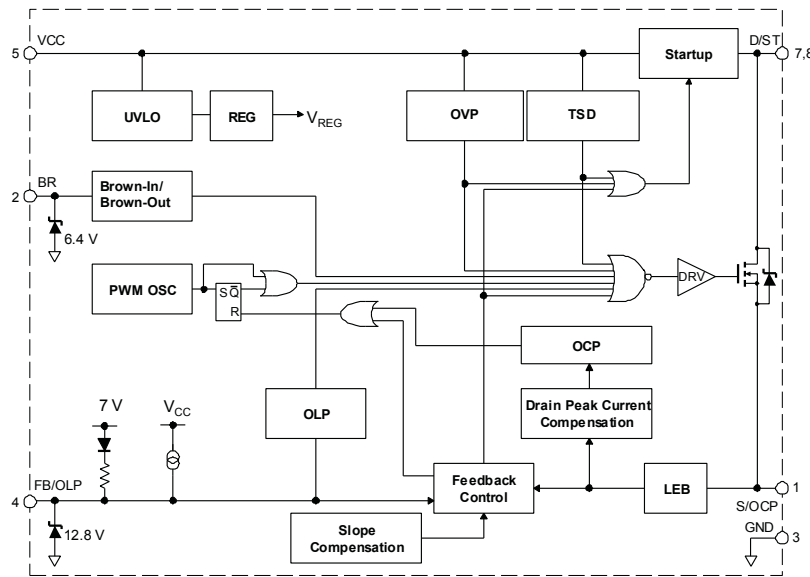

**Pin-out Diagram**

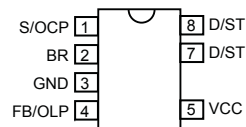

**Pin List Table**

Number	Name	Function
1	S/OCP	MOSFET source, and input for Overcurrent Protection (OCP) signal
2	BR	Input for Brown-In and Brown-Out detection voltage
3	GND	Ground
4	FB/OLP	Feedback signal input for constant voltage control signal, and input of Overload Protection (OLP) signal
5	VCC	Power supply voltage input for Control Part and input of Overvoltage Protection (OVP) signal
6	—	(Pin removed)
7, 8	D/ST	MOSFET drain, and input of the startup current



# STR-A6000M Series

# PWM Off-Line Switching Regulator ICs

## Package Diagram

- DIP8 package
- The following show a representative type of DIP8.
- The pin 6 is removed to provide greater creepage and clearance isolation between the high voltage pins (pins 7 and 8: D/ST) and the low voltage pin (pin 5: VCC).

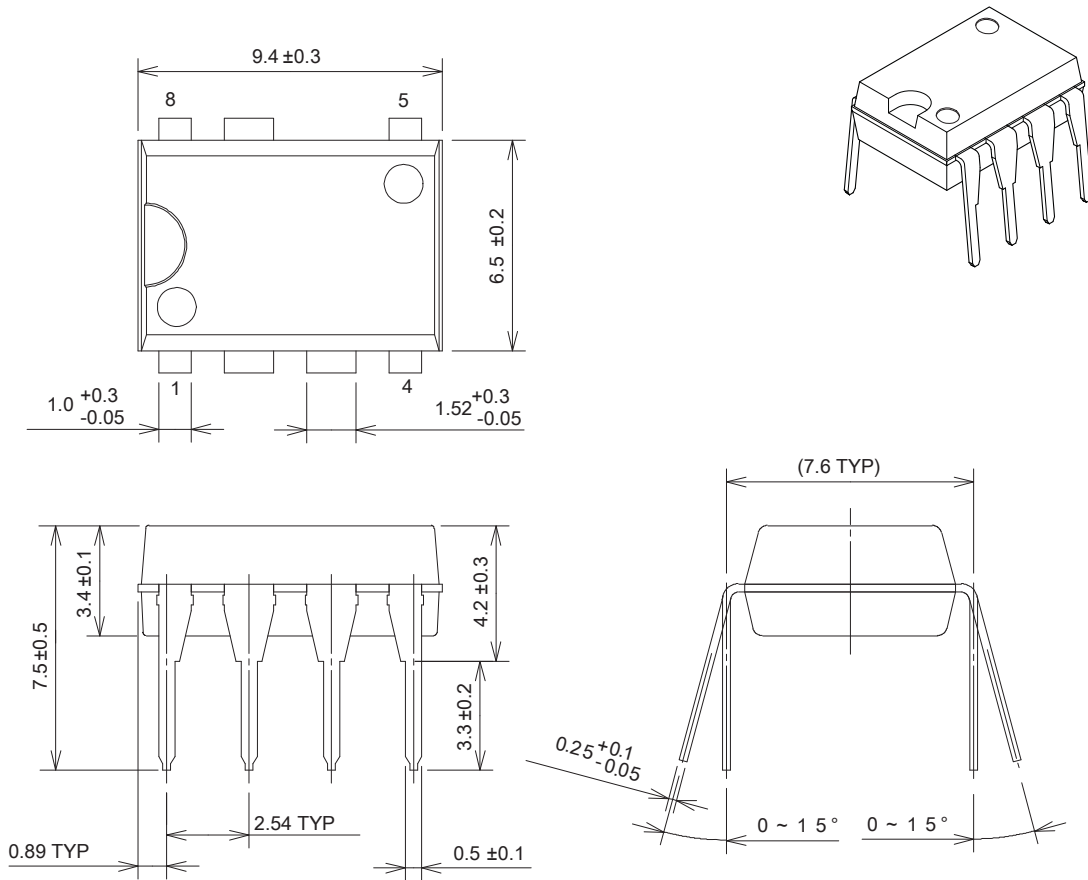

Unit: mm

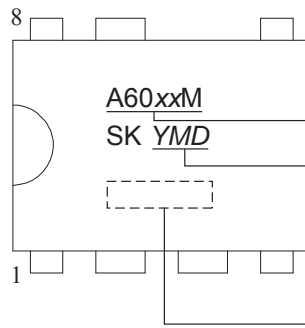

Part Number

Lot Number

Y is the last digit of the year (0 to 9)

M is the month (1 to 9, O, N, or D)

D is a period of days (1 to 3):

1 – 1<sup>st</sup> to 10<sup>th</sup>

2 – 11<sup>th</sup> to 20<sup>th</sup>

3 – 21<sup>st</sup> to 31<sup>st</sup>

Sanken Control Number



Device composition compliant with the RoHS directive.

**Operating Precautions**

In the case that you use Sanken products or design your products by using Sanken products, the reliability largely depends on the degree of derating to be made to the rated values. Derating may be interpreted as a case that an operation range is set by derating the load from each rated value or surge voltage or noise is considered for derating in order to assure or improve the reliability. In general, derating factors include electric stresses such as electric voltage, electric current, electric power etc., environmental stresses such as ambient temperature, humidity etc. and thermal stress caused due to self-heating of semiconductor products. For these stresses, instantaneous values, maximum values and minimum values must be taken into consideration. In addition, it should be noted that since power devices or IC's including power devices have large self-heating value, the degree of derating of junction temperature affects the reliability significantly.

Because reliability can be affected adversely by improper storage environments and handling methods, please observe the following cautions.

**Cautions for Storage**

- Ensure that storage conditions comply with the standard temperature (5 to 35°C) and the standard relative humidity (around 40 to 75%); avoid storage locations that experience extreme changes in temperature or humidity.
- Avoid locations where dust or harmful gases are present and avoid direct sunlight.
- Reinspect for rust on leads and solderability of the products that have been stored for a long time.

**Cautions for Testing and Handling**

When tests are carried out during inspection testing and other standard test periods, protect the products from power surges from the testing device, shorts between the product pins, and wrong connections. Ensure all test parameters are within the ratings specified by Sanken for the products.

**Remarks About Using Silicone Grease with a Heatsink**

- When silicone grease is used in mounting the products on a heatsink, it shall be applied evenly and thinly. If more silicone grease than required is applied, it may produce excess stress.

- Volatile-type silicone greases may crack after long periods of time, resulting in reduced heat radiation effect. Silicone greases with low consistency (hard grease) may cause cracks in the mold resin when screwing the products to a heatsink.

Our recommended silicone greases for heat radiation purposes, which will not cause any adverse effect on the product life, are indicated below:

Type	Suppliers
G746	Shin-Etsu Chemical Co., Ltd.
YG6260	Momentive Performance Materials Inc.
SC102	Dow Corning Toray Co., Ltd.

**Soldering**

- When soldering the products, please be sure to minimize the working time, within the following limits:

260 ± 5 °C      10 ± 1 s (Flow, 2 times)

380 ± 10 °C      3.5 ± 0.5 s (Soldering iron, 1 time)

- Soldering should be at a distance of at least 1.5 mm from the body of the products.

**Electrostatic Discharge**

- When handling the products, the operator must be grounded. Grounded wrist straps worn should have at least 1MΩ of resistance from the operator to ground to prevent shock hazard, and it should be placed near the operator.
- Workbenches where the products are handled should be grounded and be provided with conductive table and floor mats.
- When using measuring equipment such as a curve tracer, the equipment should be grounded.
- When soldering the products, the head of soldering irons or the solder bath must be grounded in order to prevent leak voltages generated by them from being applied to the products.
- The products should always be stored and transported in Sanken shipping containers or conductive containers, or be wrapped in aluminum foil.

IMPORTANT NOTES

- The contents in this document are subject to changes, for improvement and other purposes, without notice. Make sure that this is the latest revision of the document before use.
- Application and operation examples described in this document are quoted for the sole purpose of reference for the use of the products herein and Sanken can assume no responsibility for any infringement of industrial property rights, intellectual property rights or any other rights of Sanken or any third party which may result from its use. Unless otherwise agreed in writing by Sanken, Sanken makes no warranties of any kind, whether express or implied, as to the products, including product merchantability, and fitness for a particular purpose and special environment, and the information, including its accuracy, usefulness, and reliability, included in this document.
- Although Sanken undertakes to enhance the quality and reliability of its products, the occurrence of failure and defect of semiconductor products at a certain rate is inevitable. Users of Sanken products are requested to take, at their own risk, preventative measures including safety design of the equipment or systems against any possible injury, death, fires or damages to the society due to device failure or malfunction.
- Sanken products listed in this document are designed and intended for the use as components in general purpose electronic equipment or apparatus (home appliances, office equipment, telecommunication equipment, measuring equipment, etc.).

When considering the use of Sanken products in the applications where higher reliability is required (transportation equipment and its control systems, traffic signal control systems or equipment, fire/crime alarm systems, various safety devices, etc.), and whenever long life expectancy is required even in general purpose electronic equipment or apparatus, please contact your nearest Sanken sales representative to discuss, prior to the use of the products herein.

The use of Sanken products without the written consent of Sanken in the applications where extremely high reliability is required (aerospace equipment, nuclear power control systems, life support systems, etc.) is strictly prohibited.

- When using the products specified herein by either (i) combining other products or materials therewith or (ii) physically, chemically or otherwise processing or treating the products, please duly consider all possible risks that may result from all such uses in advance and proceed therewith at your own responsibility.
- Anti radioactive ray design is not considered for the products listed herein.
- Sanken assumes no responsibility for any troubles, such as dropping products caused during transportation out of Sanken's distribution network.
- The contents in this document must not be transcribed or copied without Sanken's written consent.