

Coaxial

# Voltage Controlled Oscillator

## ZX95-5150+

5V Tuning for PLL IC's 4920 to 5080 MHz

### Features

- linear tuning characteristics
- low phase noise
- low pushing
- low pulling
- protected by US patent 6,790,049

### Applications

- r & d
- lab
- instrumentation
- wireless communications
- satellite systems
- point-to-point radio
- radar



CASE STYLE: GB956

Connectors	Model
SMA	ZX95-5150-S+

### +RoHS Compliant

The +Suffix identifies RoHS Compliance. See our web site for RoHS Compliance methodologies and qualifications

### Electrical Specifications

MODEL NO.	FREQ. (MHz)		POWER OUTPUT (dBm)	PHASE NOISE dBc/Hz SSB at offset frequencies, kHz				TUNING					NON HARMONIC SPURIOUS (dBc)	HARMONICS (dBc)		PULLING pk-pk @ 12 dB (MHz)	PUSHING (MHz/V)	DC OPERATING POWER				
	Min.	Max.		Typ.	1	10	100	1000	VOLTAGE RANGE (V)		PORT SENSITIVITY (MHz/V)	CAP (pF)		3 dB MODULATION BANDWIDTH (MHz)	Typ.			Typ.	Typ.	Typ.	Vcc (volts)	Current (mA)
	Min.	Max.							Min.	Max.												
ZX95-5150+	4920	5080	+4	-69	-95	-116	-135	0.3	5	66-81	10	200	-90	-30	-19	2	2.5	5	55			

### Maximum Ratings

Operating Temperature	-55°C to 85°C
Storage Temperature	-55°C to 100°C
Absolute Max. Supply Voltage (Vcc)	6.0V
Absolute Max. Tuning Voltage (Vtune)	7.0V
All specifications	50 ohm system

Permanent damage may occur if any of these limits are exceeded.



NOTE: When soldering the DC connections, caution must be used to avoid overheating the DC terminals. See Application Note [AN-40-10](#).

### Outline Drawing

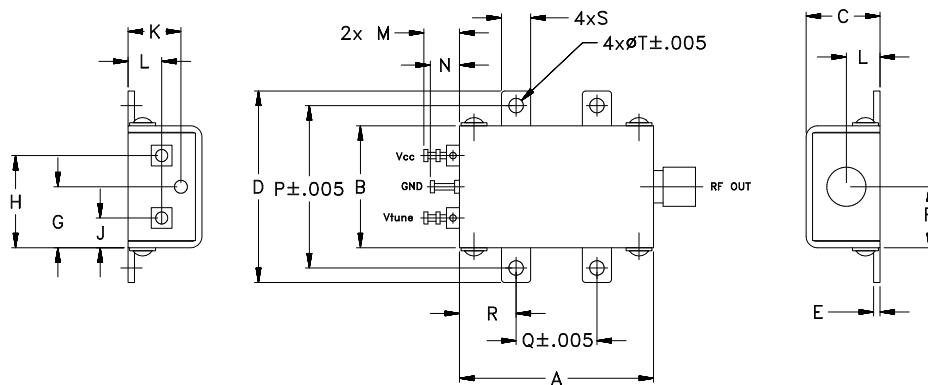

### Outline Dimensions (inch/mm)

A	B	C	D	E	F	G	H	J	K	L	M	N	P	Q	R	S	T	wt.
1.20	.75	.46	1.18	.04	.38	.38	.57	.18	.33	.21	.22	.18	1.00	.50	.35	.18	.106	grams
30.48	19.05	11.68	29.97	1.02	9.65	9.65	14.48	4.57	8.38	5.33	5.59	4.57	25.40	12.70	8.89	4.57	2.69	35.0

#### Notes

- A. Performance and quality attributes and conditions not expressly stated in this specification document are intended to be excluded and do not form a part of this specification document.  
 B. Electrical specifications and performance data contained in this specification document are based on Mini-Circuits' applicable established test performance criteria and measurement instructions.  
 C. The parts covered by this specification document are subject to Mini-Circuits standard limited warranty and terms and conditions (collectively, "Standard Terms"); Purchasers of this part are entitled to the rights and benefits contained therein. For a full statement of the Standard Terms and the exclusive rights and remedies thereunder, please visit Mini-Circuits' website at [www.minicircuits.com/MCLStore/terms.jsp](http://www.minicircuits.com/MCLStore/terms.jsp)



[www.minicircuits.com](http://www.minicircuits.com) P.O. Box 350166, Brooklyn, NY 11235-0003 (718) 934-4500 sales@minicircuits.com

REV. C  
 M163863  
 EDR-11327/2  
 ZX95-5150+  
 RAV  
 171017  
 Page 1 of 2

# Performance Data & Curves\*

# ZX95-5150+

V TUNE	TUNE SENS (MHz/V)	FREQUENCY (MHz)			POWER OUTPUT (dBm)			Icc (mA)	HARMONICS (dBc)			FREQ. PUSH (MHz/V)	FREQ. PULL (MHz)	PHASE NOISE (dBc/Hz) at offsets				FREQ OFFSET (kHz)	PHASE NOISE at 5000 MHz (dBc/Hz)
		-55°C	+25°C	+85°C	-55°C	+25°C	+85°C		F2	F3	F4			1kHz	10kHz	100kHz	1MHz		
0.00	113.01	4821.8	4786.1	4770.2	4.40	3.86	3.12	44.41	-34.7	-49.0	-47.6	2.97	0.17	-70.50	-95.1	-116.0	-136.2	1.0	-69.73
0.30	102.67	4853.5	4819.6	4803.9	4.21	3.82	3.37	44.43	-33.9	-48.4	-48.4	2.14	0.20	-70.67	-95.2	-116.2	-136.2	2.5	-81.19
0.50	93.84	4872.8	4840.6	4824.8	4.07	3.84	3.39	44.48	-33.9	-48.0	-47.5	1.65	0.21	-72.01	-96.4	-116.9	-136.7	4.2	-86.85
1.00	88.93	4916.7	4884.4	4871.4	4.31	3.77	3.24	44.57	-36.0	-50.1	-47.9	1.06	0.15	-71.61	-95.9	-116.9	-136.8	7.2	-92.54
1.25	86.32	4938.4	4906.6	4891.5	4.10	4.00	3.17	44.51	-36.1	-47.6	-48.7	0.99	0.14	-70.97	-95.6	-116.7	-136.5	8.7	-94.21
1.50	81.00	4958.3	4928.2	4912.7	3.83	3.90	3.36	44.50	-40.2	-47.0	-49.9	0.90	0.14	-70.25	-94.9	-115.8	-136.0	10.0	-95.18
1.75	72.28	4977.5	4948.4	4933.4	3.85	3.74	3.34	44.57	-35.9	-48.4	-47.3	0.69	0.14	-72.33	-95.7	-116.9	-136.9	23.9	-103.61
2.00	75.94	4997.1	4966.5	4953.0	4.01	3.66	3.12	44.60	-36.3	-46.9	-47.9	0.64	0.16	-71.86	-96.2	-117.2	-137.3	40.1	-108.35
2.25	73.78	5015.2	4985.5	4971.1	4.04	3.94	2.97	44.56	-35.4	-46.2	-50.5	0.58	0.17	-70.48	-95.3	-116.3	-136.5	66.1	-112.74
2.43	75.26	5028.6	4998.8	4984.6	3.97	3.99	3.01	44.54	-35.3	-46.8	-52.5	0.57	0.17	-69.73	-95.2	-116.2	-136.4	79.0	-114.40
2.75	72.63	5052.0	5022.9	5008.3	3.74	3.89	3.13	44.49	-33.8	-45.4	-52.6	0.57	0.17	-69.75	-94.6	-115.8	-135.9	100.0	-116.23
3.00	71.36	5069.5	5041.0	5026.2	3.49	3.63	3.09	44.48	-34.1	-43.5	-53.6	0.52	0.20	-70.87	-94.7	-115.8	-136.0	155.7	-120.32
3.25	67.38	5086.3	5058.9	5044.1	3.33	3.51	2.90	44.49	-31.9	-44.4	-57.1	0.47	0.23	-69.73	-95.2	-116.0	-136.2	182.8	-121.72
3.50	66.40	5104.0	5075.7	5061.8	3.40	3.50	2.68	44.49	-32.3	-43.2	-55.7	0.43	0.25	-69.75	-95.2	-116.0	-136.0	218.5	-123.43
3.75	69.23	5121.2	5092.3	5078.3	3.44	3.51	2.49	44.44	-30.5	-41.5	-55.5	0.42	0.25	-68.19	-94.2	-115.3	-134.5	306.7	-126.26
4.00	66.83	5137.8	5109.6	5094.5	3.36	3.56	2.32	44.38	-31.8	-42.7	-56.8	0.38	0.26	-68.46	-94.1	-115.1	-135.1	360.2	-127.72
4.25	64.87	5154.0	5126.3	5111.2	3.20	3.40	2.41	44.34	-29.5	-42.7	-57.2	0.35	0.28	-68.22	-93.9	-114.8	-135.0	505.5	-130.66
4.50	59.93	5169.7	5142.6	5127.4	2.95	3.18	2.40	44.31	-30.4	-41.8	-56.0	0.27	0.28	-68.90	-93.5	-114.7	-134.9	604.2	-132.08
4.75	59.98	5185.9	5157.5	5142.5	2.87	3.00	2.35	44.29	-28.9	-41.6	-56.0	0.19	0.27	-68.87	-94.0	-115.0	-135.0	995.8	-136.39
5.00	58.98	5200.9	5172.5	5157.5	2.74	2.85	2.19	44.23	-27.6	-41.7	-55.9	0.12	0.26	-67.39	-92.9	-113.7	-133.8	1000.0	-136.40

\*at 25°C unless mentioned otherwise

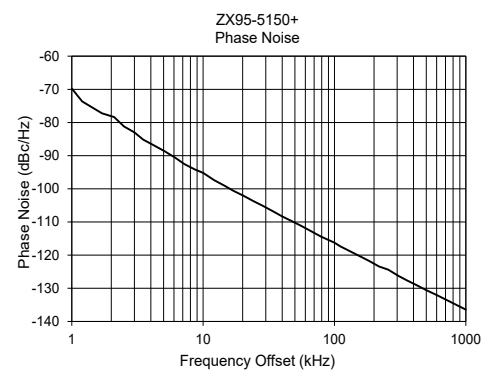
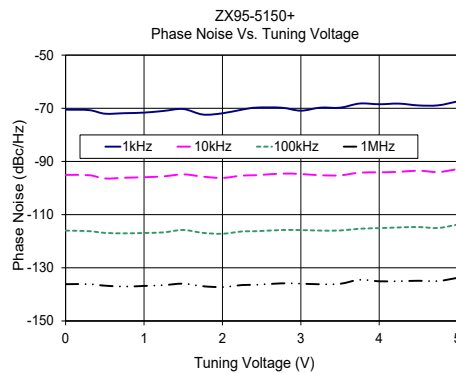
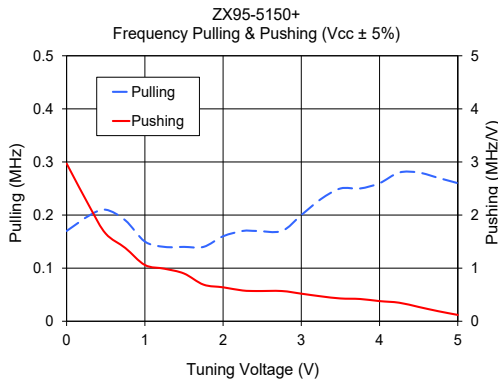
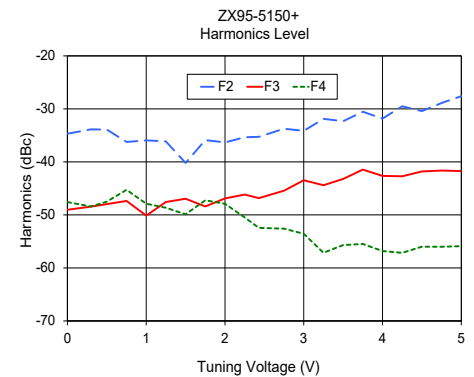
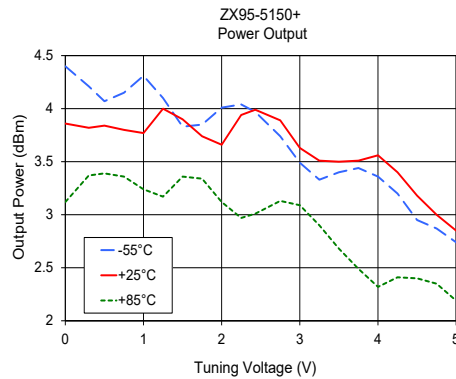
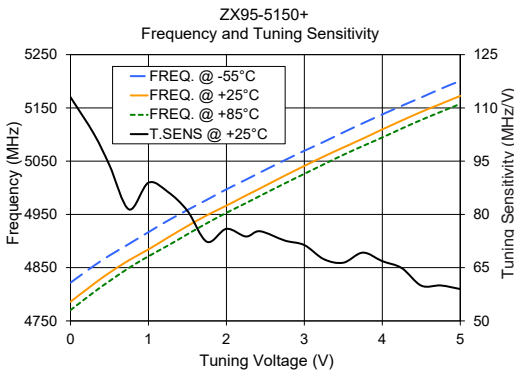

### Notes

- A. Performance and quality attributes and conditions not expressly stated in this specification document are intended to be excluded and do not form a part of this specification document.
- B. Electrical specifications and performance data contained in this specification document are based on Mini-Circuit's applicable established test performance criteria and measurement instructions.
- C. The parts covered by this specification document are subject to Mini-Circuits standard limited warranty and terms and conditions (collectively, "Standard Terms"); Purchasers of this part are entitled to the rights and benefits contained therein. For a full statement of the Standard Terms and the exclusive rights and remedies thereunder, please visit Mini-Circuits' website at [www.minicircuits.com/MCLStore/terms.jsp](http://www.minicircuits.com/MCLStore/terms.jsp)

