

1. PART NO. EXPRESSION :

L 4 - 4 7 N K - 1 0
 (a) (b) (c) (d)

- (a) Series code
- (b) Inductance code : 47N = 0.047uH
- (c) Tolerance code : K = ±10%, M = ±20%
- (d) 10 : Lead Free

2. CONFIGURATION & DIMENSIONS :

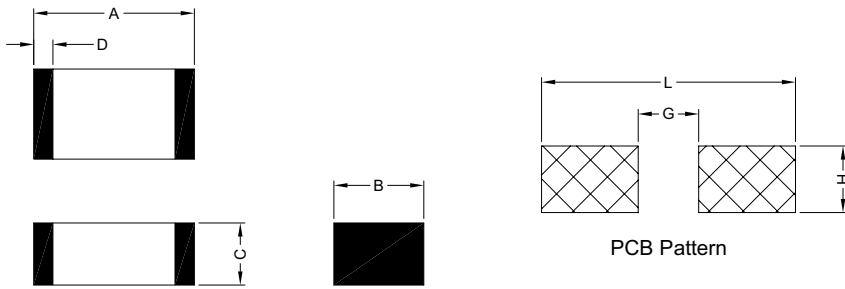

Unit:m/m

| A | B | C | D | G | H | L |
|-----------|-----------|-----------|-----------|-----------|-----------|-----------|
| 3.20±0.20 | 1.60±0.20 | 1.10±0.30 | 0.50±0.30 | 2.20 Ref. | 1.40 Ref. | 4.40 Ref. |

3. SCHEMATIC :

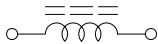

4. MATERIALS :

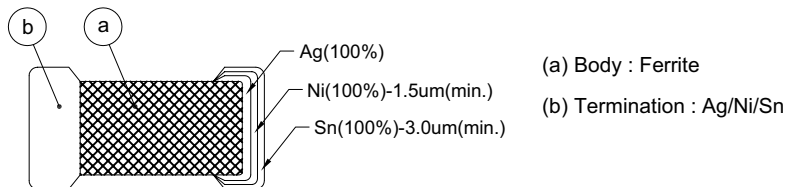

5. GENERAL SPECIFICATION :

- a) Temp. rise : 30°C Max.
- b) Rated current : Base on temp. rise
- c) Storage temp. : -40°C to +85°C
- d) Operating temp. : -40°C to +85°C
- e) Resistance to solder heat : 260°C.10secs



RoHS Compliant

NOTE : Specifications subject to change without notice. Please check our website for latest information.

15.01.2008



SUPERWORLD ELECTRONICS (S) PTE LTD

6. ELECTRICAL CHARACTERISTICS :

| Part Number | EIA Size | Inductance (μ H) | Q Min | Test Frequency (MHz) | SRF (MHz) Min. | DC Resistance (Ω) Max. | Rated Current (mA) |
|-------------|----------|------------------------|-------|------------------------|------------------|---------------------------------|----------------------|
| L4-47N -10 | 1206 | 0.047 | 20 | 50 | 320 | 0.15 | 300 |
| L4-68N -10 | 1206 | 0.068 | 20 | 50 | 280 | 0.25 | 300 |
| L4-R10 -10 | 1206 | 0.100 | 20 | 25 | 235 | 0.25 | 250 |
| L4-R12 -10 | 1206 | 0.120 | 20 | 25 | 220 | 0.30 | 250 |
| L4-R15 -10 | 1206 | 0.150 | 20 | 25 | 200 | 0.30 | 250 |
| L4-R18 -10 | 1206 | 0.180 | 20 | 25 | 185 | 0.40 | 250 |
| L4-R22 -10 | 1206 | 0.220 | 20 | 25 | 170 | 0.40 | 250 |
| L4-R27 -10 | 1206 | 0.270 | 20 | 25 | 150 | 0.50 | 250 |
| L4-R33 -10 | 1206 | 0.330 | 20 | 25 | 145 | 0.50 | 250 |
| L4-R39 -10 | 1206 | 0.390 | 25 | 25 | 135 | 0.60 | 250 |
| L4-R47 -10 | 1206 | 0.470 | 25 | 25 | 125 | 0.60 | 200 |
| L4-R56 -10 | 1206 | 0.560 | 25 | 25 | 115 | 0.70 | 200 |
| L4-R68 -10 | 1206 | 0.680 | 25 | 25 | 105 | 0.80 | 150 |
| L4-R82 -10 | 1206 | 0.820 | 25 | 25 | 100 | 0.90 | 150 |
| L4-1R0 -10 | 1206 | 1.000 | 45 | 10 | 75 | 0.40 | 100 |
| L4-1R2 -10 | 1206 | 1.200 | 45 | 10 | 65 | 0.50 | 100 |
| L4-1R5 -10 | 1206 | 1.500 | 45 | 10 | 60 | 0.50 | 50 |
| L4-1R8 -10 | 1206 | 1.800 | 45 | 10 | 55 | 0.50 | 50 |
| L4-2R2 -10 | 1206 | 2.200 | 45 | 10 | 50 | 0.60 | 50 |
| L4-2R7 -10 | 1206 | 2.700 | 45 | 10 | 45 | 0.60 | 50 |
| L4-3R3 -10 | 1206 | 3.300 | 45 | 10 | 41 | 0.70 | 50 |
| L4-3R9 -10 | 1206 | 3.900 | 45 | 10 | 38 | 0.80 | 50 |
| L4-4R7 -10 | 1206 | 4.700 | 45 | 10 | 35 | 0.90 | 50 |
| L4-5R6 -10 | 1206 | 5.600 | 50 | 4 | 32 | 0.70 | 25 |
| L4-6R8 -10 | 1206 | 6.800 | 50 | 4 | 29 | 0.80 | 25 |
| L4-8R2 -10 | 1206 | 8.200 | 50 | 4 | 26 | 0.90 | 25 |
| L4-100 -10 | 1206 | 10.000 | 50 | 2 | 24 | 1.00 | 25 |
| L4-120 -10 | 1206 | 12.000 | 50 | 2 | 22 | 1.05 | 15 |
| L4-150 -10 | 1206 | 15.000 | 35 | 1 | 19 | 0.70 | 5 |
| L4-180 -10 | 1206 | 18.000 | 35 | 1 | 18 | 0.70 | 5 |
| L4-220 -10 | 1206 | 22.000 | 35 | 1 | 16 | 0.90 | 5 |
| L4-270 -10 | 1206 | 27.000 | 35 | 1 | 14 | 0.90 | 5 |
| L4-330 -10 | 1206 | 33.000 | 35 | 0.4 | 13 | 1.05 | 5 |

Inductance tolerance :

: K : \pm 10%

M : \pm 20%



RoHS Compliant

NOTE : Specifications subject to change without notice. Please check our website for latest information.

15.01.2008



SUPERWORLD ELECTRONICS (S) PTE LTD

7. IMPEDANCE VS. FREQUENCY CURVES :

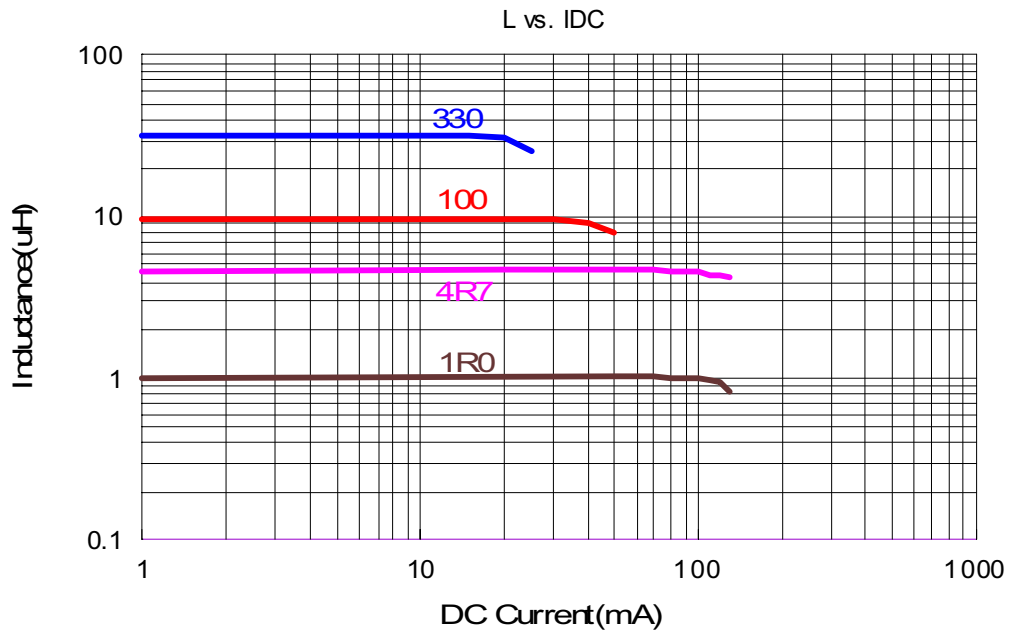
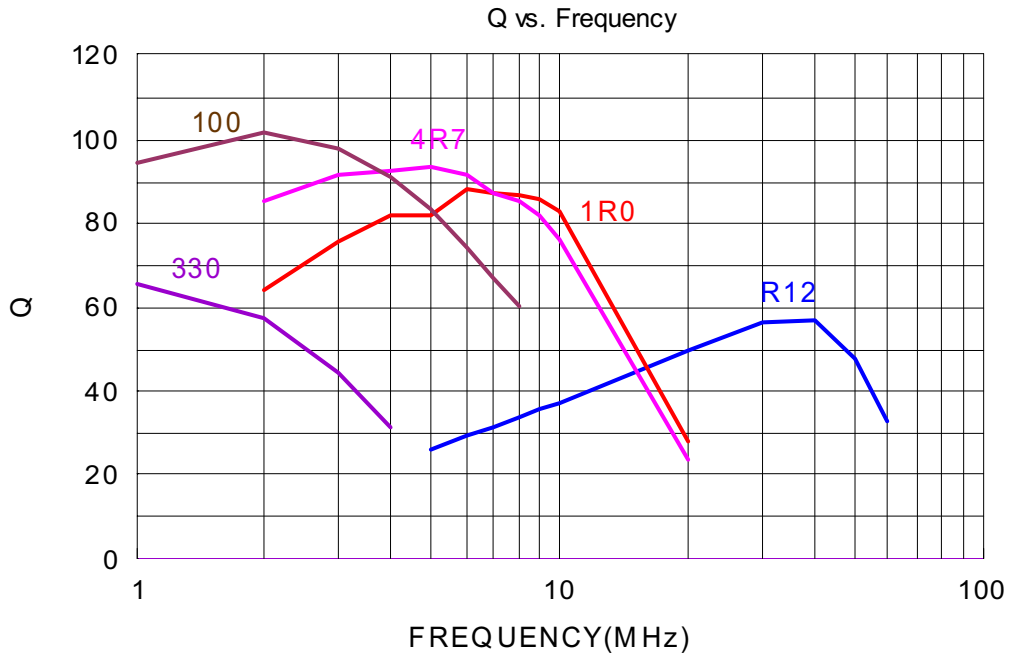

RoHS Compliant

NOTE : Specifications subject to change without notice. Please check our website for latest information.

15.01.2008



SUPERWORLD ELECTRONICS (S) PTE LTD

8. RELIABILITY & TEST CONDITION :

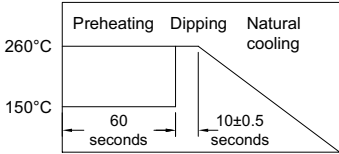
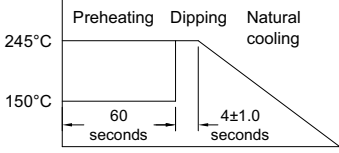
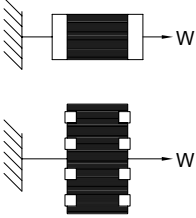
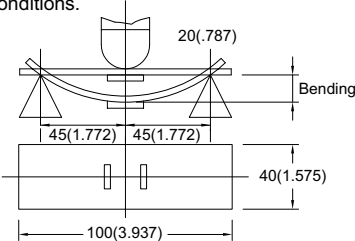
| ITEM | PERFORMANCE | TEST CONDITION | | | | | | | | | | | | | | | | | | | | | | | | | | | |
|---------------------------------|---|---|------|-------------|------------|---|-----|--|---|-----|--|---|-----|--|---|-----|------|---|-----|--|---|-----|--|---|-----|--|---|-----|--|
| Electrical Characteristics Test | | | | | | | | | | | | | | | | | | | | | | | | | | | | | |
| Impedance | Refer to standard electrical characteristics list | HP4291A, HP4287A+16092A | | | | | | | | | | | | | | | | | | | | | | | | | | | |
| DC Resistance | | HP4338B | | | | | | | | | | | | | | | | | | | | | | | | | | | |
| Rated Current | | | | | | | | | | | | | | | | | | | | | | | | | | | | | |
| Temperature Rise Test | 30°C max. (Δt) | 1. Applied the allowed DC current. 2. Temperature measured by digital surface thermometer. | | | | | | | | | | | | | | | | | | | | | | | | | | | |
| Solder Heat Resistance | No mechanical damage Remaining terminal electrode : 70% min.  | Preheat : 150°C, 60sec. Solder : Sn-Ag3.0-Cu0.5 Solder Temperature : 260±5°C Flux for lead free : rosin Dip Time : 10±0.5sec. | | | | | | | | | | | | | | | | | | | | | | | | | | | |
| Solderability | More than 90% of the terminal electrode should be covered with solder.  | Preheat : 150°C, 60sec. Solder : Sn-Ag3.0-Cu0.5 Solder Temperature : 245±5°C Flux for lead free : rosin Dip Time : 4±1sec. | | | | | | | | | | | | | | | | | | | | | | | | | | | |
| Terminal Strength | The terminal electrode & the dielectric must not be damaged by the forces applied on the right conditions.  | For Z / L Series : <table border="1" data-bbox="911 1099 1254 1368"> <thead> <tr> <th>Size</th> <th>Force (Kfg)</th> <th>Time (sec)</th> </tr> </thead> <tbody> <tr> <td>1</td> <td>0.2</td> <td></td> </tr> <tr> <td>2</td> <td>0.5</td> <td></td> </tr> <tr> <td>3</td> <td>0.6</td> <td></td> </tr> <tr> <td>4</td> <td>1.0</td> <td>> 25</td> </tr> <tr> <td>5</td> <td>1.0</td> <td></td> </tr> <tr> <td>6</td> <td>1.0</td> <td></td> </tr> <tr> <td>7</td> <td>1.5</td> <td></td> </tr> <tr> <td>8</td> <td>2.0</td> <td></td> </tr> </tbody> </table> | Size | Force (Kfg) | Time (sec) | 1 | 0.2 | | 2 | 0.5 | | 3 | 0.6 | | 4 | 1.0 | > 25 | 5 | 1.0 | | 6 | 1.0 | | 7 | 1.5 | | 8 | 2.0 | |
| Size | Force (Kfg) | Time (sec) | | | | | | | | | | | | | | | | | | | | | | | | | | | |
| 1 | 0.2 | | | | | | | | | | | | | | | | | | | | | | | | | | | | |
| 2 | 0.5 | | | | | | | | | | | | | | | | | | | | | | | | | | | | |
| 3 | 0.6 | | | | | | | | | | | | | | | | | | | | | | | | | | | | |
| 4 | 1.0 | > 25 | | | | | | | | | | | | | | | | | | | | | | | | | | | |
| 5 | 1.0 | | | | | | | | | | | | | | | | | | | | | | | | | | | | |
| 6 | 1.0 | | | | | | | | | | | | | | | | | | | | | | | | | | | | |
| 7 | 1.5 | | | | | | | | | | | | | | | | | | | | | | | | | | | | |
| 8 | 2.0 | | | | | | | | | | | | | | | | | | | | | | | | | | | | |
| Flexure Strength | The terminal electrode & the dielectric must not be damaged by the forces applied on the right conditions.  | Solder a chip on a test substrate, bend the substrate by 2mm (0.079in) and return. | | | | | | | | | | | | | | | | | | | | | | | | | | | |



RoHS Compliant

NOTE : Specifications subject to change without notice. Please check our website for latest information.

15.01.2008



SUPERWORLD ELECTRONICS (S) PTE LTD

8. RELIABILITY & TEST CONDITION :

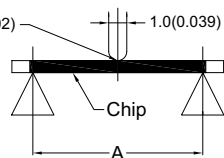
| ITEM | PERFORMANCE | TEST CONDITION | | | | | | | | | | | | | | | | | | |
|------------------------------|--|---|----------------------------------|--------------|-------|---------------------------|--------------|-----|---------------------------|--------------|---|---|--------------|-----|---|---|--------------|-----|---|---|
| Bending Strength | <p>The ferrite should not be damaged by forces applied on the right condition.</p>  | <p>For Z / L Series :</p> <table border="1"> <thead> <tr> <th>Series name</th> <th>mm (inches)</th> <th>P-Kgf</th> </tr> </thead> <tbody> <tr> <td>2</td> <td>0.80 (0.033)</td> <td>0.3</td> </tr> <tr> <td>3</td> <td>1.40 (0.055)</td> <td>1.0</td> </tr> <tr> <td>4</td> <td rowspan="2">2.00 (0.079)</td> <td rowspan="2">2.5</td> </tr> <tr> <td>5</td> </tr> <tr> <td>6</td> <td rowspan="3">2.70 (0.106)</td> <td rowspan="3">2.5</td> </tr> <tr> <td>7</td> </tr> <tr> <td>8</td> </tr> </tbody> </table> | Series name | mm (inches) | P-Kgf | 2 | 0.80 (0.033) | 0.3 | 3 | 1.40 (0.055) | 1.0 | 4 | 2.00 (0.079) | 2.5 | 5 | 6 | 2.70 (0.106) | 2.5 | 7 | 8 |
| Series name | mm (inches) | P-Kgf | | | | | | | | | | | | | | | | | | |
| 2 | 0.80 (0.033) | 0.3 | | | | | | | | | | | | | | | | | | |
| 3 | 1.40 (0.055) | 1.0 | | | | | | | | | | | | | | | | | | |
| 4 | 2.00 (0.079) | 2.5 | | | | | | | | | | | | | | | | | | |
| 5 | | | | | | | | | | | | | | | | | | | | |
| 6 | 2.70 (0.106) | 2.5 | | | | | | | | | | | | | | | | | | |
| 7 | | | | | | | | | | | | | | | | | | | | |
| 8 | | | | | | | | | | | | | | | | | | | | |
| Random Vibration Test | Appearance : Cracking, shipping & any other defects harmful to the characteristics should not be allowed. | <p>Frequency : 10-55-10Hz for 1 min. Amplitude : 1.52mm Directions & times : X, Y, Z directions for 2 hours. A period of 2 hours in each of 3 mutually perpendicular directions (Total 6 hours).</p> | | | | | | | | | | | | | | | | | | |
| Drop | Drop 10 times on a concrete floor from a height of 75cm. | No mechanical damage | | | | | | | | | | | | | | | | | | |
| Loading at High Temperature | <p>Appearance : No damage. Inductance : Within $\pm 10\%$ of initial value. Q : Within $\pm 30\%$ of initial value.</p> | <p>Temperature : $85 \pm 5^\circ\text{C}$ Applied Current : rated current Duration : 1008 ± 12hrs Measured at room temperature after placing for 2 to 3hrs.</p> | | | | | | | | | | | | | | | | | | |
| Humidity | | <p>Humidity : 90~95% RH. Temperature : $40 \pm 2^\circ\text{C}$ Duration : 1008 ± 12hrs Measured at room temperature after placing for 2 to 3hrs.</p> | | | | | | | | | | | | | | | | | | |
| Thermal Shock | <p>Appearance : No damage. Inductance : Within $\pm 10\%$ of initial value. Q : Within $\pm 30\%$ of initial value.</p> <table border="1"> <thead> <tr> <th>Phase</th> <th>Temperature ($^\circ\text{C}$)</th> <th>Times (min.)</th> </tr> </thead> <tbody> <tr> <td>1</td> <td>$-40 \pm 2^\circ\text{C}$</td> <td>30 ± 3</td> </tr> <tr> <td>2</td> <td>$+85 \pm 5^\circ\text{C}$</td> <td>30 ± 3</td> </tr> </tbody> </table> | Phase | Temperature ($^\circ\text{C}$) | Times (min.) | 1 | $-40 \pm 2^\circ\text{C}$ | 30 ± 3 | 2 | $+85 \pm 5^\circ\text{C}$ | 30 ± 3 | <p>For L Series : Condition for 1 cycle Step1 : $-40 \pm 2^\circ\text{C}$ 30 ± 3 min. Step2 : $+85 \pm 5^\circ\text{C}$ 30 ± 3 min. Number of cycles : 100 Measured at room temperature after placing for 2 to 3hrs.</p> | | | | | | | | | |
| Phase | Temperature ($^\circ\text{C}$) | Times (min.) | | | | | | | | | | | | | | | | | | |
| 1 | $-40 \pm 2^\circ\text{C}$ | 30 ± 3 | | | | | | | | | | | | | | | | | | |
| 2 | $+85 \pm 5^\circ\text{C}$ | 30 ± 3 | | | | | | | | | | | | | | | | | | |
| Low temperature storage test | Measured : 100 times | <p>Temperature : $-55 \pm 2^\circ\text{C}$ Duration : 1008 ± 12hrs Measured at room temperature after placing for 2 to 3hrs.</p> | | | | | | | | | | | | | | | | | | |
| Drop | Drop 10 times on a concrete floor from a height of 75cm. | No mechanical damage | | | | | | | | | | | | | | | | | | |

Derating Curve

For the ferrite chip bead which withstanding current over 1.5A, as the operating temperature over 85°C , the derating current information is necessary to consider with. For the detail derating of current, please refer to the Derated Current vs. Operating Temperature curve.

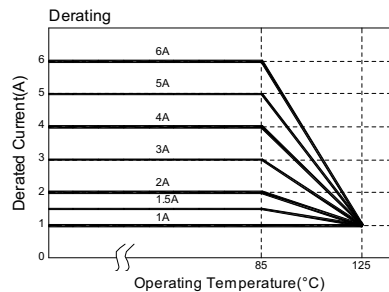

RoHS Compliant

NOTE : Specifications subject to change without notice. Please check our website for latest information.



9. SOLDERING AND MOUNTING :

9-1. Recommended PC Board Pattern

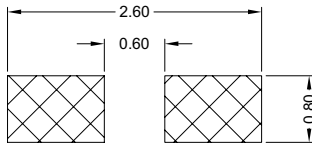

PC board should be designed so that products are not sufficient under mechanical stress as warping the board. Products shall be positioned in the sideways direction against the mechanical stress to prevent failure.

9-2. Soldering

Mildly activated rosin fluxes are preferred. The minimum amount of solder can lead to damage from the stresses caused by the difference in coefficients of expansion between solder, chip and substrate. The terminations are suitable for all wave and re-flow soldering systems. If hand soldering cannot be avoided, the preferred technique is the utilization of hot air soldering tools.

9-2.1 Lead Free Solder Re-flow :

Recommended temperature profiles for re-flow soldering in Figure 1.

9-2.2 Solder Wave :

Wave soldering is perhaps the most rigorous of surface mount soldering processes due to the steep rise in temperature seen by the circuit when immersed in the molten solder wave, typical at 230°C. Due to the risk of thermal damage to products, wave soldering of large size products is discouraged. Recommended temperature profile for wave soldering is shown in Fig. 2

9-2.3 Soldering Iron (Figure 3) :

Products attachment with soldering iron is discouraged due to the inherent process control limitations. In the event that a soldering iron must be employed the following precautions are recommended.

Note :

- a) Preheat circuit and products to 150°C.
- b) 350°C tip temperature (max)
- c) Never contact the ceramic with the iron tip
- d) 1.0mm tip diameter (max)
- e) Use a 20 watt soldering iron with tip diameter of 1.0mm
- f) Limit soldering time to 3 secs.

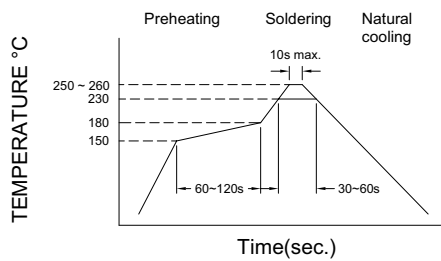

Figure 1. Re-flow Soldering

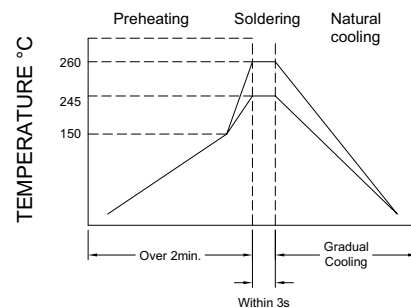

Figure 2. Wave Soldering

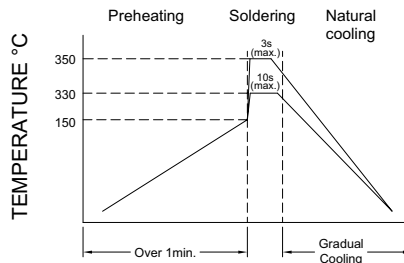

Figure 3. Hand Soldering



RoHS Compliant

NOTE : Specifications subject to change without notice. Please check our website for latest information.

15.01.2008



SUPERWORLD ELECTRONICS (S) PTE LTD

9-3. Solder Volume

Accordingly increasing the solder volume, the mechanical stress to product is also increased. Exceeding solder volume may cause the failure of mechanical or electrical performance. Solder shall be used not to be exceed as shown in Fig. 4.

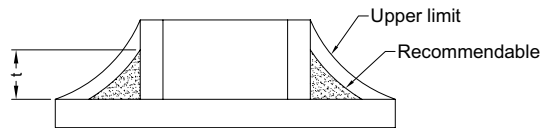

Figure 4



RoHS Compliant

NOTE : Specifications subject to change without notice. Please check our website for latest information.

15.01.2008



SUPERWORLD ELECTRONICS (S) PTE LTD

10. PACKAGING INFORMATION :

10-1. Reel Dimension

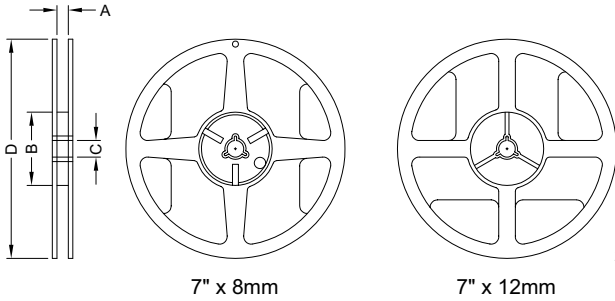

| Type | A(mm) | B(mm) | C(mm) | D(mm) |
|-----------|----------|----------|----------|-----------|
| 7" x 8mm | 9.0±0.5 | 60.0±2.0 | 13.5±0.5 | 178.0±2.0 |
| 7" x 12mm | 13.5±0.5 | 60.0±2.0 | 13.5±0.5 | 178.0±2.0 |

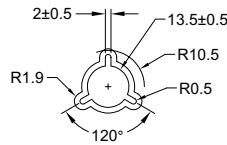

10-2 Tape Dimension / 8mm

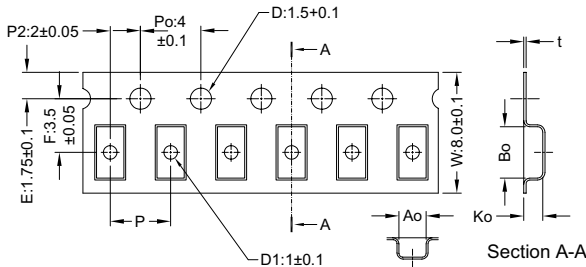

| Series | Size | Bo(mm) | Ao(mm) | Ko(mm) | P(mm) | t(mm) | D1(mm) |
|--------|-----------|-----------|-----------|-----------|-----------|-----------|---------|
| Z / L | 1 | 1.12±0.05 | 0.67±0.05 | 0.54±0.05 | 2.0±0.1 | 0.23±0.05 | none |
| | 2 | 1.80±0.10 | 1.01±0.10 | 1.02±0.10 | 4.0±0.1 | 0.22±0.05 | none |
| | 3 (09) | 2.25±0.10 | 1.42±0.10 | 1.04±0.10 | 4.0±0.1 | 0.22±0.05 | 1.0±0.1 |
| | 3 (12) | 2.35±0.10 | 1.50±0.10 | 1.45±0.10 | 4.0±0.1 | 0.22±0.05 | 1.0±0.1 |
| | 4 | 3.50±0.10 | 1.88±0.10 | 1.27±0.10 | 4.0±0.1 | 0.22±0.05 | 1.0±0.1 |
| 5 | 3.42±0.10 | 2.77±0.10 | 1.55±0.10 | 4.0±0.1 | 0.22±0.05 | 1.0±0.1 | |

10-2.1 Tape Dimension / 12mm

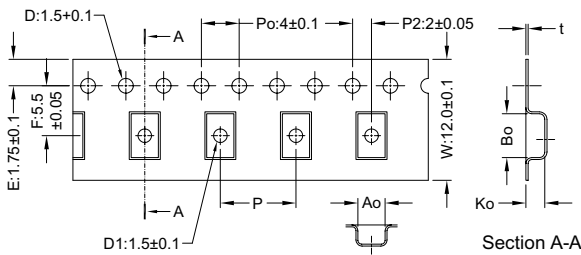

| Series | Size | Bo(mm) | Ao(mm) | Ko(mm) | P(mm) | t(mm) | D1(mm) |
|--------|------|----------|----------|----------|---------|-----------|---------|
| Z / L | 6 | 4.95±0.1 | 1.93±0.1 | 1.93±0.1 | 4.0±0.1 | 0.24±0.05 | 1.5±0.1 |
| | 7 | 4.95±0.1 | 3.66±0.1 | 1.85±0.1 | 8.0±0.1 | 0.24±0.05 | 1.5±0.1 |
| | 8 | 6.10±0.1 | 5.40±0.1 | 2.00±0.1 | 8.0±0.1 | 0.30±0.05 | 1.5±0.1 |

10-3. Packaging Quantity

| Chip Size | 8 | 7 | 6 | 5 | 4 | 3 (12) | 3 (09) | 2 | 1 |
|-------------|-------|-------|-------|--------|--------|--------|--------|--------|--------|
| Chip / Reel | 1000 | 1000 | 2000 | 2500 | 3000 | 2000 | 4000 | 4000 | 10000 |
| Inner Box | 4000 | 4000 | 8000 | 12500 | 15000 | 10000 | 20000 | 20000 | 50000 |
| Middle Box | 20000 | 20000 | 40000 | 62500 | 75000 | 50000 | 100000 | 100000 | 250000 |
| Carton | 40000 | 40000 | 80000 | 125000 | 150000 | 100000 | 200000 | 200000 | 500000 |
| Bulk (Bags) | 7000 | 12000 | 20000 | 30000 | 50000 | 100000 | 150000 | 200000 | 300000 |



RoHS Compliant

NOTE : Specifications subject to change without notice. Please check our website for latest information.

15.01.2008



SUPERWORLD ELECTRONICS (S) PTE LTD

10-4. Tearing Off Force

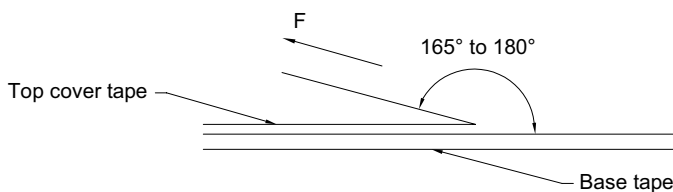

The force for tearing off cover tape is 15 to 60 grams in the arrow direction under the following conditions.

| Room Temp. (°C) | Room Humidity (%) | Room atm (hPa) | Tearing Speed (mm/min) |
|-----------------|-------------------|----------------|------------------------|
| 5~35 | 45~85 | 860~1060 | 300 |

Application Notice

1. Storage Conditions :

To maintain the solderability of terminal electrodes :

- a) Temperature and humidity conditions : 10 ~ 40°C and 30 ~ 70% RH.
- b) Recommended products should be used within 6 months from the time of delivery.
- c) The packaging material should be kept where no chlorine or sulfur exists in the air.

2. Transportation :

- a) Products should be handled with care to avoid damage or contamination from perspiration and skin oils.
- b) The use of tweezers or vacuum pick up is strongly recommended for individual components.
- c) Bulk handling should ensure that abrasion and mechanical shock are minimized.



RoHS Compliant

NOTE : Specifications subject to change without notice. Please check our website for latest information.

15.01.2008



SUPERWORLD ELECTRONICS (S) PTE LTD