

TSR-3006 & 3362

玻璃釉微調電位器

TSR-3006

- 多圈的/金屬陶瓷/工業用/密封
(Multiturn/ Cermet/ Industrial/ Sealed)
- 3種引線的安裝尺寸
(3 Terminal Styles)

TSR-3362

- 單圈的/金屬陶瓷/工業用/密封
(Single Turn/ Cermet/ Industrial/ Sealed)
- 9種引線的安裝尺寸
(9 Terminal Styles)

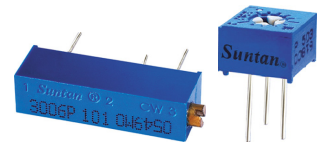

TSR-3006 TSR-3362

電氣特性	Electrical Characteristics	
	TSR-3006	TSR-3362
標稱阻值範圍 Standard Resistance Range	10Ω - 5MΩ	10Ω - 5MΩ
阻值允許偏差 Resistance Tolerance	±10%	±10%
終端電阻 Absolute Minimum Resistance	≤1% R 或 5n	≤1% R 或 10n
接觸電阻變化 Contact Resistance Variation	CRV≤4%或 5n	CRV≤3%或 5Ω
絕緣電阻 Insulation Resistance	R1≥1GΩ(100Vac)	R1≥1GΩ(500Vac)
耐電壓 Withstand Voltage	640Vac	700Vac
有效行程 Effective Travel	22±2 turns nom	250°±10°

環境特性	Environmental Characteristics	
	TSR-3006	TSR-3362
額定功率 Power Rating (315volts max)	0.75W@70°C, 0W@125°C	0.5W@70°C, 0W@125°C
溫度範圍 Temperature Range	-55°C ~ +125°C	-55°C ~ +125°C
溫度系數 Temperature Coefficient	250 ± 或 ±100ppm/°C	250 或 ±100ppm/°C
溫度變化 Temperature Variation	-55°C, 30min, +125°C 30min, 循環 5 次 5 cycles ΔR≤5%R, Δ(Uab/Uac)≤5%	-55°C, 30min, +125°C 30min, 循環 5 次 5 cycles ΔR≤5%R, Δ(Uab/Uac)≤5%
振動 Vibration	10 - 500Hz, 0.75mm, 6h ΔR≤5%R, Δ(Uab/Uac)≤7.5%	10 - 500Hz, 0.75mm, 6h ΔR≤5%R, Δ(Uab/Uac)≤7.5%
碰撞 Collision	390m/s ² , 4000cycles, ΔR≤2%R	390m/s ² , 4000cycles, ΔR≤5%R
70°C 耐久性 Electrical Endurance at 70°C	0.75W@70°C 1000h, ΔR≤5%R CRV≤3% or 5Ω	0.5W@70°C 1000h, ΔR≤10%R R1≥100MΩ
機械壽命 Rotational Life	200 周 (200 cycles) ΔTR≤10%R, CRV≤3% or 5n	200 周 (200 cycles) ΔTR≤10%R, CRV≤3% or 5n

阻值代碼表 Standard Resistance table

Resistance(Ohms)	Resistance Code
10	100
20	200
50	500
100	101
150	151
200	201
250	251
300	301
470	471
500	501
680	681
1,000	102
1,500	152
2,000	202
2,200	222
2,500	252
3,000	302
4,700	472
5,000	502
6,800	682
10,000	103
15,000	153
20,000	203
22,000	223
25,000	253
30,000	303
33,000	333
47,000	473
50,000	503
68,000	683
100,000	104
150,000	154
200,000	204
220,000	224
250,000	254
300,000	304
330,000	334
470,000	474
500,000	504
680,000	684
1,000,000	105
2,000,000	205
2,200,000	225
5,000,000	505

訂購指南 How to Order

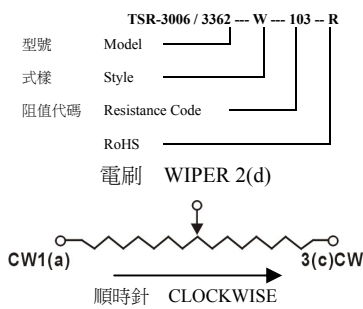

圖中公差：除注明外均為±0.25
Tolerance is ±0.25 if no identification

物理特性	Physical Characteristics	
	TSR-3006	TSR-3362
起動力矩 Starting Torque	≤35mN·m	≤35mN·m
標誌 Marking	阻值允許偏差(±10%不標註) 阻值代碼 產品型號 Resistance Tolerance Resistance Code, Model	阻值允許偏差(±10%不標註) 阻值代碼 產品型號 Resistance Tolerance Resistance Code, Model
標準包裝 Standard Packaging	25 只/管 (25pcs, per tube)	50 只/管 (50pcs, per tube)

可按用戶要求提供特殊規格
Special resistances available.

TSR-3006

共有尺寸 Common Dimensions

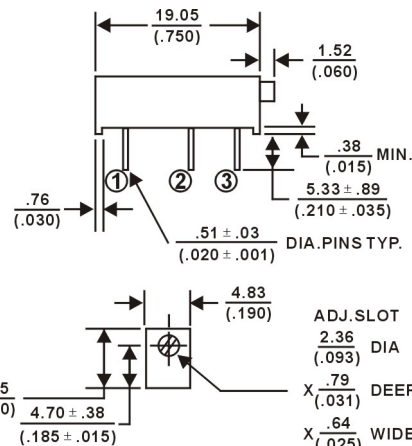

TSR-3006W

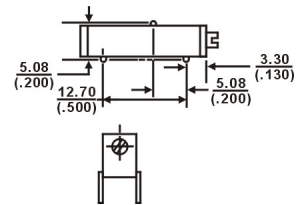

TSR-3006Y

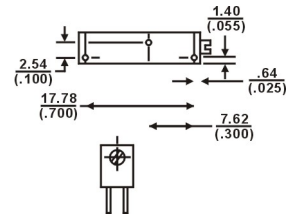

TSR-3006P

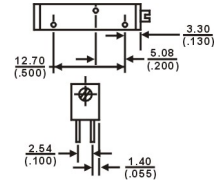

TSR-3362

Common Dimensions
Top Adjust
頂調式

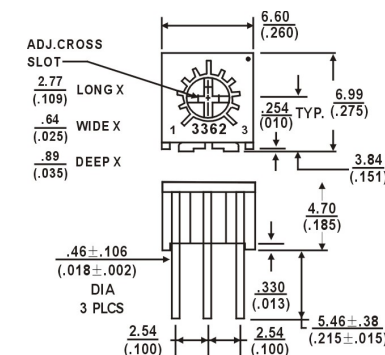

Common Dimensions
Side Adjust
側調式

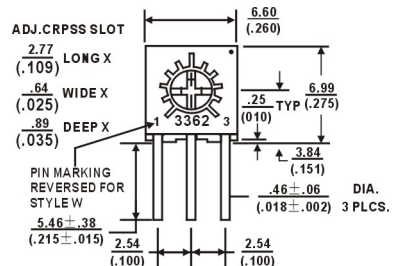

TSR-3362H

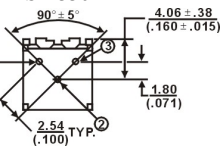

TSR-3362R

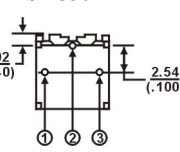

TSR-3362P

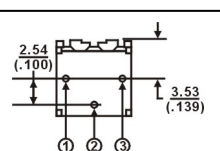

TSR-3362U

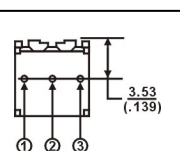

TSR-3362S

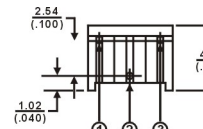

TSR-3362X

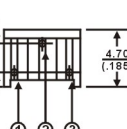

TSR-3362W

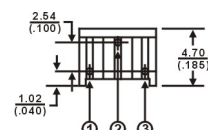

TSR-3362Z

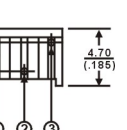

TSR-3362M

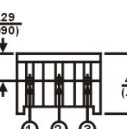

Note: Specification are subject to change without notice. For more detail and update, please visit our website.