

SPL-F280PPC2W04

SLG

SWITCHING AUTOMATION LIGHT GRIDS

SICK
Sensor Intelligence.



Ordering information

Type	Part no.
SPL-F280PPC2W04	1211691

Other models and accessories → www.sick.de/SLG



Detailed technical data

Features

Technology	Sender/receiver
Minimum detectable object (MDO)	Parallel beam, 45 mm
Beam separation	40 mm
Optical light exit	Flat
Number of beams	≥ 8
Detection height	280 mm
Configuration	Without teach button with configuration software
Cross beam/parallel beam	Parallel beam active
Output 1	Output 1 active, if light beam interrupted
Automatic teach	Automatic teach active
Alignment aid	Without alignment aid
Muting function	Muting function deactivated

Performance

Maximum range	3 m ¹⁾
Minimum range	Parallel beam: ≥ 0 mm
Working range	1.5 m
Response time	Parallel beam coded version ≥ 38 ms ²⁾

¹⁾ No reserve for environmental issue and deterioration of the diode.

²⁾ With resistive load.

Interfaces

Switching output	1 x PNP
Inputs	Job LED
Connection type	Short cable with connector M8, 4-pin

Mechanics/electronics

Wave length	Infrared light, 950 nm
Supply voltage V_s	DC24 V, $\pm 20\%$
Power consumption sender	$\geq 50\text{ mA}^{1)}$
Power consumption receiver	$\geq 50\text{ mA}^{1)}$
Output current I_{\max}	$\leq 100\text{ mA}$
Output load capacitive	100 nF
Output load inductive	1 H
Initialization time	1 s
Dimensions (W x H x D)	25 mm x 352.4 mm x 8 mm
Housing material	PMMA
Indication	LED
Synchronization	Optical
Circuit protection	U_V connections, reverse polarity protected, Output Q short-circuit protected, Interference pulse suppression
Weight	$\geq 40\text{ g}$
Switching frequency	250 kHz
Aluminum stabilizer	With stabilizer

¹⁾ Without load.

Ambient data

Protection class	III
EMC	EN 60947-5-2
Ambient temperature	Operation: $-25\text{ °C} \dots +55\text{ °C}$ Storage: $-25\text{ °C} \dots +70\text{ °C}$
Ambient light immunity	Direct: 100,000 lx ¹⁾ Indirect: 150,000 lx
Vibration resistance	5 g, 10 Hz ... 55 Hz (IEC 68-2-6)
Shock load	10 g / DIN EN 60068-2-29 / 16 ms

¹⁾ Sunlight.

Dimensional drawing (Dimensions in mm (inch))

Sxx-Fxxxxxx2xxx

Flat, with stabilizer

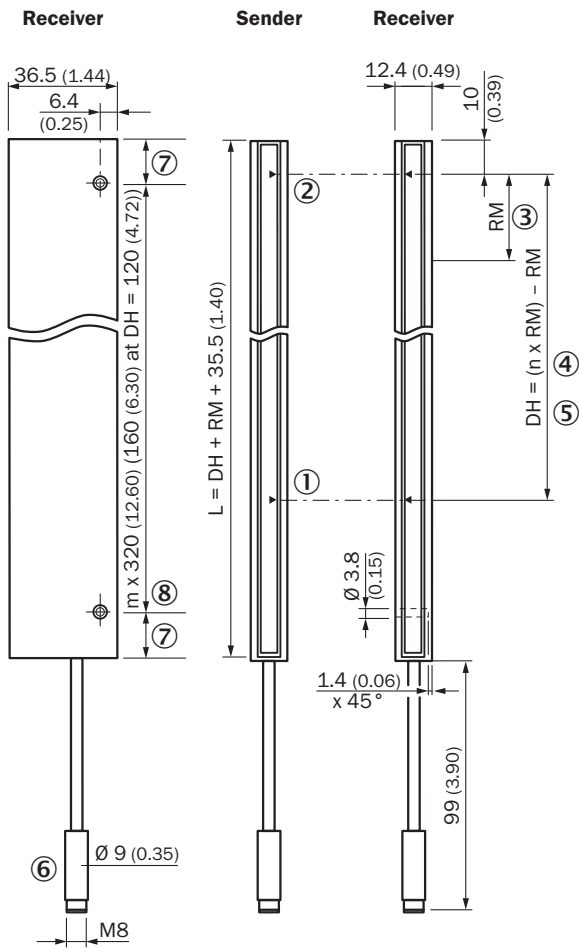

- ① First beam
- ② Last beam
- ③ Beam separation (RM)
- ④ Number of beams (n)
- ⑤ Detection height (DH)
- ⑥ Connection
- ⑦ Same distance
- ⑧ Number of mounting holes (m)

Adjustments

SPL, receiver, LED indication

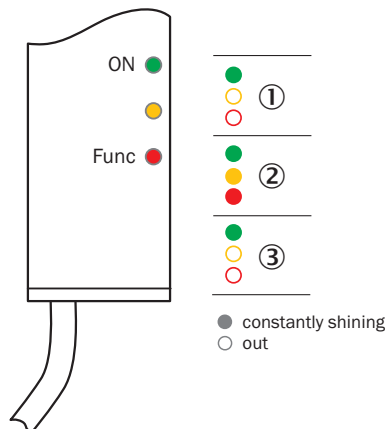

- ① Supply voltage
- ② Active if teach process active
- ③ No object in the light path

Connection type and diagram

SPL

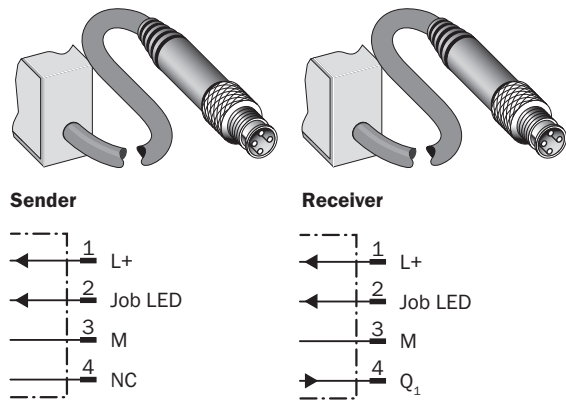

Concept of operation

SPL

Plug & play

1. Plug in and tighten the ring of the connector

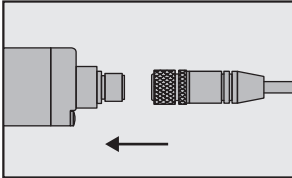

2. Device is ready for use

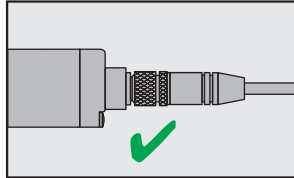

Easy installation

1. Object picking from the indicated bin

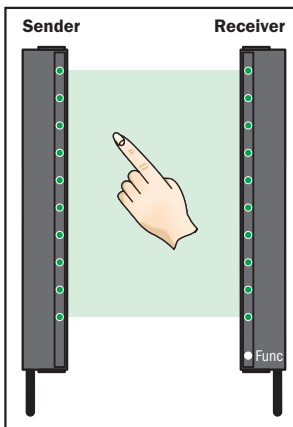

The "green" Job LEDs indicate the correct picking bin to the operator and confirm optically that the correct picking has taken place.

2. Incorrect picking

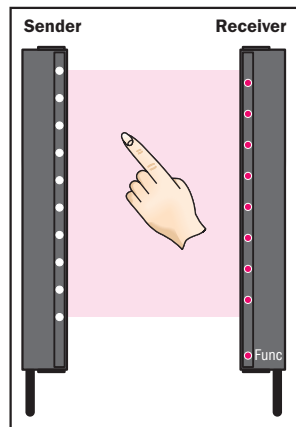

The "red" Job LEDs light in case of picking errors. The function LED "Func" will also turn "red" to indicate a picking error.

Funktionsprinzip



Slim & Flat



- ① Slim model = light emission on narrow side
- ② Flat model = light emission on broad side

Recommended accessories

Other models and accessories → www.sick.de/SLG

	Brief description	Type	Part no.
Mounting brackets and mounting plates			
	Mounting bracket for light grids up to a monitoring height of 600 mm, mounting on the face sides, 2x BEF-SLG1, 2x BEF-SLG2	BEF-SLG-SET1	2055427
Plug connectors and cables			
	Head A: female connector, M8, 4-pin, straight Head B: cable Cable: PVC, unshielded, 2 m	DOL-0804-G02M	6009870

SICK AT A GLANCE

SICK is one of the leading manufacturers of intelligent sensors and sensor solutions for industrial applications. A unique range of products and services creates the perfect basis for controlling processes securely and efficiently, protecting individuals from accidents and preventing damage to the environment.

We have extensive experience in a wide range of industries and understand their processes and requirements. With intelligent sensors, we can deliver exactly what our customers need. In application centers in Europe, Asia and North America, system solutions are tested and optimized in accordance with customer specifications. All this makes us a reliable supplier and development partner.

Comprehensive services complete our offering: SICK LifeTime Services provide support throughout the machine life cycle and ensure safety and productivity.

For us, that is “Sensor Intelligence.”

WORLDWIDE PRESENCE:

Contacts and other locations –www.sick.com