

**Product Summary**

Symbol	Value	Unit
$I_{T(RMS)}$	0.8	A
$V_{DRM} V_{RRM}$	600	V
$I_{GT}$	10~200	$\mu A$

**Feature**

With high ability to withstand the shock loading of large current, Provide high dv/dt rate with strong resistance to electromagnetic interference.

**Application**

Power charger, T-tools, massager, solid state relay, AC Motor speed regulation and so on.

**Package**



**SOT-23-3L**

**Circuit diagram**

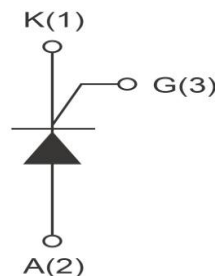

**Marking**

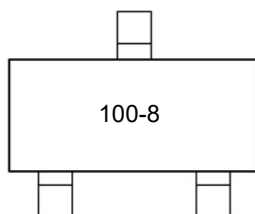

**Absolute maximum ratings (Ta=25°C unless otherwise noted)**

Parameter	Symbol	Value	Unit
Repetitive peak off-state voltage	$V_{DRM}$	600	V
Repetitive peak reverse voltage	$V_{RRM}$	600	V
RMS on-state current	$I_{T(RMS)}$	0.8	A
Non repetitive surge peak on-state current (full cycle, F=50Hz)	$I_{TSM}$	8	A
$I^2t$ value for fusing (tp=10ms)	$I^2t$	0.35	A <sup>2</sup> s
Critical rate of rise of on-state current ( $I_G = 2 \times I_{GT}$ )	$di_T/dt$	50	A/ $\mu$ s
Peak gate current	$I_{GM}$	0.2	A
Average gate power dissipation	$P_{G(AV)}$	0.1	W
Junction Temperature	$T_J$	-40 ~ +110	°C
Storage Temperature	$T_{STG}$	-40 ~ +150	°C

**Electrical characteristics (TA=25°C, unless otherwise noted)**

Parameter	Symbol	Test Condition	Value		Unit
			Min	Max	
Gate trigger current	$I_{GT}$	$V_D = 12V I_T = 10mA T_J = 25^\circ C$	10	200	$\mu A$
Gate trigger voltage	$V_{GT}$		-	0.8	V
Gate non-trigger voltage	$V_{GD}$	$V_D = 1/2 V_{DRM} T_J = 110^\circ C$	0.2	-	V
latching current	$I_L$	$V_D = 12V I_G = 0.5mA$ $R_{GK} = 1k\Omega T_J = 25^\circ C$	-	4	mA
Holding current	$I_H$		-	5	mA
Critical-rate of rise of commutation voltage	$dV_D/dt$	$V_D = 2/3 V_{DRM}$ Gate Open $T_J = 110^\circ C$	10	-	V/ $\mu$ s
<b>STATIC CHARACTERISTICS</b>					
Forward "on" voltage	$V_{TM}$	$I_{TM} = 1.2A t_p = 380\mu s$	-	1.7	V
Repetitive Peak Off-State Current	$I_{DRM}$	$V_D = V_{DRM} V_R = V_{RRM}$	$T_J = 25^\circ C$		$\mu A$
Repetitive Peak Reverse Current	$I_{RRM}$		$T_J = 110^\circ C$		mA
<b>THERMAL RESISTANCES</b>					
Thermal resistance	$R_{th(j-c)}$	Junction to case	TYP.	75	°C/W
	$R_{th(j-a)}$	Junction to ambient	TYP.	150	°C/W

**Typical Characteristics**

**FIG.1** Maximum power dissipation versus RMS on-state current

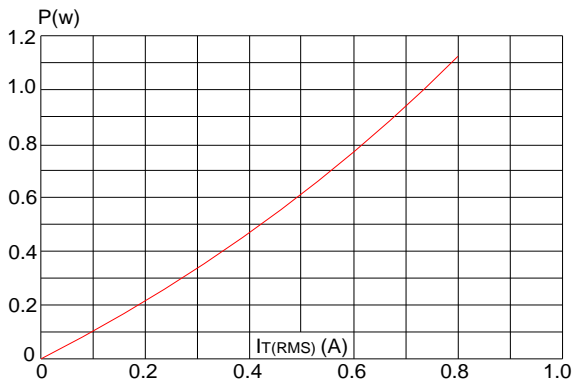

**FIG.2:** RMS on-state current versus case temperature

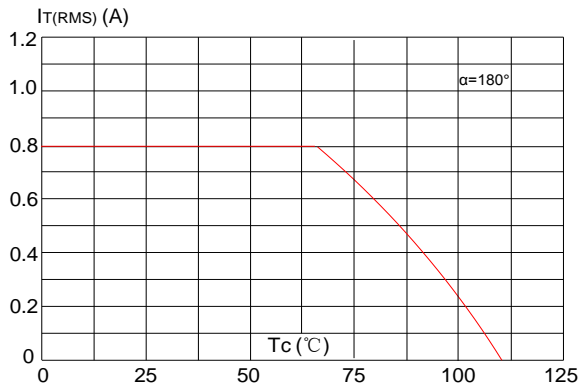

**FIG.3:** Surge peak on-state current versus number of cycles

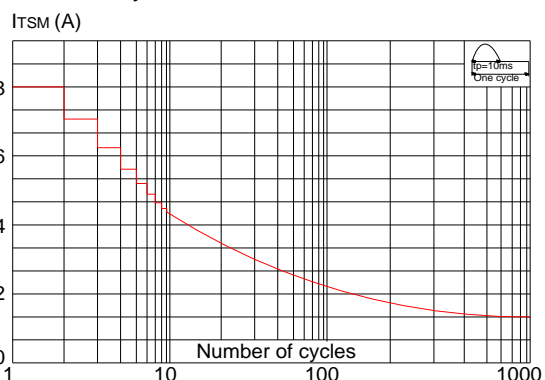

**FIG.4:** On-state characteristics (maximum values)

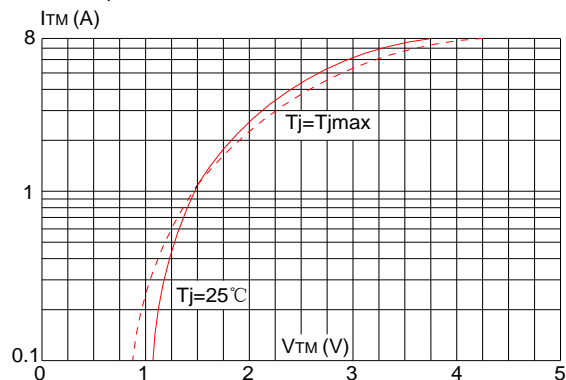

**FIG.5:** Non-repetitive surge peak on-state current for a sinusoidal pulse with width  $t_p < 10\text{ms}$ , and corresponding value of  $I^2t$

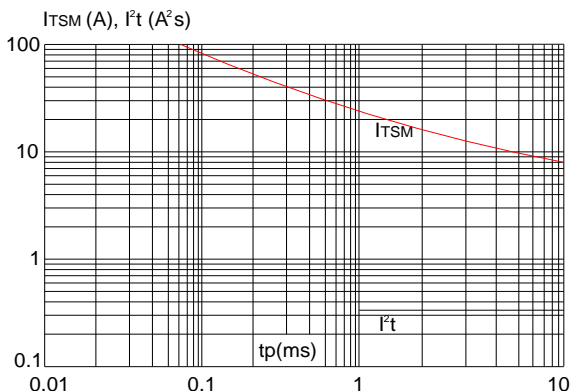

**FIG.6:** Relative variations of gate trigger current, holding current and latching current versus junction temperature

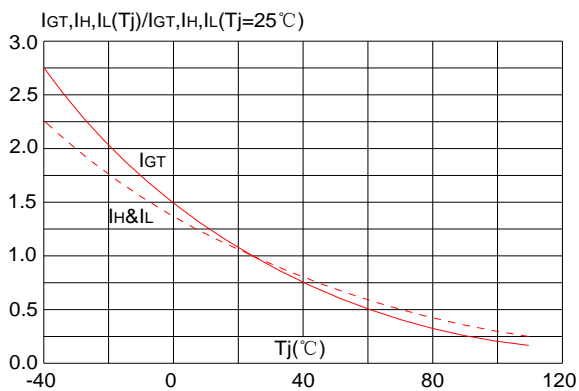

**SOT-23-3L Package Information**

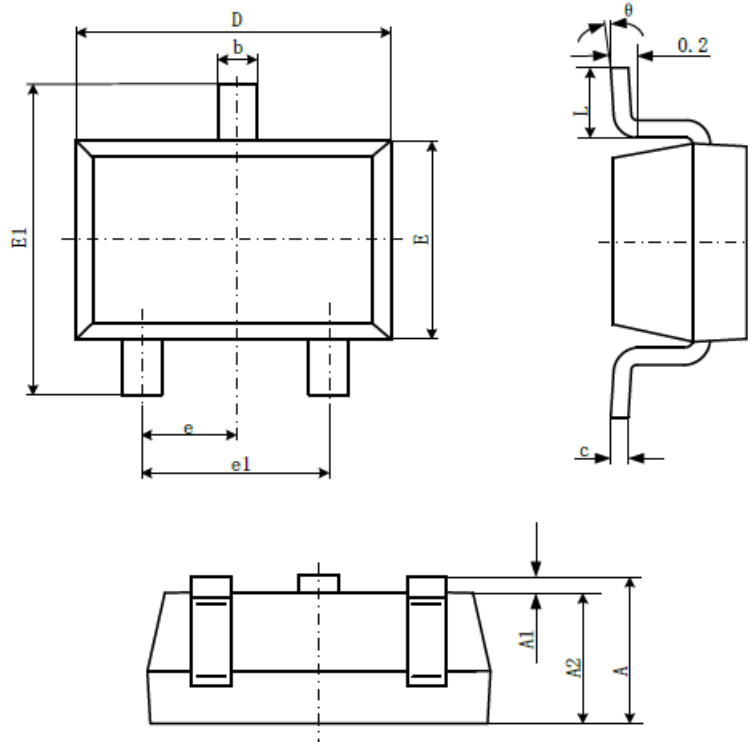

Symbol	Dimensions In Millimeters		Dimensions In Inches	
	Min	Max	Min	Max
A	1.050	1.250	0.041	0.049
A1	0.000	0.100	0.000	0.004
A2	1.050	1.150	0.041	0.045
b	0.300	0.500	0.012	0.020
c	0.100	0.200	0.004	0.008
D	2.820	3.020	0.111	0.119
E	1.500	1.700	0.059	0.067
E1	2.650	2.950	0.104	0.116
e	0.950(BSC)		0.037(BSC)	
e1	1.800	2.000	0.071	0.079
L	0.300	0.600	0.012	0.024
theta	0°	8°	0°	8°