

DALLAS
SEMICONDUCTOR

DS1245YL/BL
1024K Nonvolatile SRAM

NOT RECOMMENDED FOR NEW DESIGNS. SEE DS1245Y/AB DATA SHEET.

FEATURES

- 10 years minimum data retention in the absence of external power
- Data is automatically protected during power loss
- Unlimited write cycles
- Low-power CMOS
- Read and write access times as fast as 70 ns
- Lithium energy source is electrically disconnected to retain freshness until power is applied for the first time.
- Full $\pm 10\%$ V_{CC} operating range (DS1245YL)
- Optional $\pm 5\%$ V_{CC} operating range DS1245BL)
- Optional industrial temperature range of -40°C to $+85^{\circ}\text{C}$, designated IND
- Low Profile Module (LPM) package
 - Fits into standard 68-pin PLCC surface-mountable sockets
 - 250 mil package height

DESCRIPTION

The DS1245 1024K Nonvolatile SRAMs are 1,048,576-bit, fully static, nonvolatile SRAMs organized as 131,072 words by 8 bits. Each NV SRAM has a self-contained lithium energy source and control circuitry which constantly monitors V_{CC} for an out-of-tolerance condition. When such a condition occurs, the lithi-

PIN ASSIGNMENT

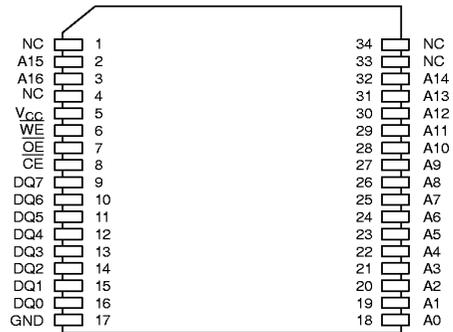

34-PIN LOW PROFILE MODULE (LPM)

PIN DESCRIPTION

A0 – A16	– Address Inputs
DQ0 – DQ7	– Data In/Data Out
$\overline{\text{CE}}$	– Chip Enable
$\overline{\text{WE}}$	– Write Enable
$\overline{\text{OE}}$	– Output Enable
V_{CC}	– Power (+5V)
GND	– Ground
NC	– No Connect

um energy source is automatically switched on and write protection is unconditionally enabled to prevent data corruption. There is no limit on the number of write cycles which can be executed and no additional support circuitry is required for microprocessor interfacing.

READ MODE

The DS1245 devices execute a read cycle whenever \overline{WE} (Write Enable) is inactive (high) and \overline{CE} (Chip Enable) and \overline{OE} (Output Enable) are active (low). The unique address specified by the 17 address inputs ($A_0 - A_{16}$) defines which of the 131,072 bytes of data is accessed. Valid data will be available to the eight data output drivers within t_{ACC} (Access Time) after the last address input signal is stable, providing that \overline{CE} and \overline{OE} access times are also satisfied. If \overline{OE} and \overline{CE} access times are not satisfied, then data access must be measured from the later occurring signal (\overline{CE} or \overline{OE}) and the limiting parameter is either t_{CO} for \overline{CE} or t_{OE} for \overline{OE} rather than address access.

WRITE MODE

The DS1245 devices execute a write cycle whenever the \overline{WE} and \overline{CE} signals are active (low) after address inputs are stable. The later occurring falling edge of \overline{CE} or \overline{WE} will determine the start of the write cycle. The write cycle is terminated by the earlier rising edge of \overline{CE} or \overline{WE} . All address inputs must be kept valid throughout the write cycle. \overline{WE} must return to the high state for a minimum recovery time (t_{WR}) before another cycle can be initiated. The \overline{OE} control signal should be kept inactive (high) during write cycles to avoid bus contention. However, if the output drivers are enabled (\overline{CE} and \overline{OE} active) then \overline{WE} will disable the outputs in t_{ODW} from its falling edge.

DATA RETENTION MODE

The DS1245BL provides full functional capability for V_{CC} greater than 4.75 volts and write protects by 4.5 volts. The DS1245YL provides full functional capability for V_{CC} greater than 4.5V and write protects by 4.25 volts. Data is maintained in the absence of V_{CC} without any additional support circuitry. The nonvolatile static RAMs constantly monitor V_{CC} . Should the supply voltage decay, the NV SRAMs automatically write protect themselves, all inputs become "don't care," and all outputs become high impedance. As V_{CC} falls below approximately 3.0 volts, a power switching circuit connects the lithium energy source to RAM to retain data. During power-up, when V_{CC} rises above approximately 3.0 volts, the power switching circuit connects external V_{CC} to RAM and disconnects the lithium energy source. Normal RAM operation can resume after V_{CC} exceeds 4.75 volts for the DS1245BL and 4.5 volts for the DS1245YL.

FRESHNESS SEAL

Each DS1245 device is shipped from Dallas Semiconductor with its lithium energy source disconnected, guaranteeing full energy capacity. When V_{CC} is first applied at a level greater than V_{TP} , the lithium energy source is enabled for battery backup operation.

ABSOLUTE MAXIMUM RATINGS*

Voltage on Any Pin Relative to Ground	-0.3V to +7.0V
Operating Temperature	0°C to 70°C, -40°C to +85°C for Ind parts
Storage Temperature	-40°C to +70°C, -40°C to +85°C for Ind parts
Soldering Temperature	260°C for 10 seconds

* This is a stress rating only and functional operation of the device at these or any other conditions above those indicated in the operation sections of this specification is not implied. Exposure to absolute maximum rating conditions for extended periods of time may affect reliability.

RECOMMENDED DC OPERATING CONDITIONS(t_A: See Note 10)

PARAMETER	SYMBOL	MIN	TYP	MAX	UNITS	NOTES
DS1245BL Power Supply Voltage	V _{CC}	4.75	5.0	5.25	V	
DS1245YL Power Supply Voltage	V _{CC}	4.5	5.0	5.5	V	
Logic 1	V _{IH}	2.2		V _{CC}	V	
Logic 0	V _{IL}	0.0		+0.8	V	

DC ELECTRICAL CHARACTERISTICS(V_{CC}=5V ± 5% for DS1245BL)
(t_A: See Note 10) (V_{CC}=5V ± 10% for DS1245YL)

PARAMETER	SYMBOL	MIN	TYP	MAX	UNITS	NOTES
Input Leakage Current	I _{IL}	-1.0		+1.0	μA	
I/O Leakage Current CE ≥ V _{IH} ≤ V _{CC}	I _{IO}	-1.0		+1.0	μA	
Output Current @ 2.4V	I _{OH}	-1.0			mA	
Output Current @ 0.4V	I _{OL}	2.0			mA	
Standby Current CE=2.2V	I _{CCS1}		5.0	10.0	mA	
Standby Current CE=V _{CC} -0.5V	I _{CCS2}		3.0	5.0	mA	
Operating Current	I _{CCO1}			85	mA	
Write Protection Voltage (DS1245BL)	V _{TP}	4.50	4.62	4.75	V	
Write Protection Voltage (DS1245YL)	V _{TP}	4.25	4.37	4.5	V	

CAPACITANCE(t_A = 25°C)

PARAMETER	SYMBOL	MIN	TYP	MAX	UNITS	NOTES
Input Capacitance	C _{IN}		5	10	pF	
Input/Output Capacitance	C _{I/O}		5	10	pF	

(V_{CC}=5V ± 5% for DS1245BL)**AC ELECTRICAL CHARACTERISTICS**(t_A: See Note 10) (V_{CC}=5V ± 10% for DS1245YL)

PARAMETER	SYMBOL	DS1245BL-70 DS1245YL-70		DS1245BL-100 DS1245YL-100		UNITS	NOTES
		MIN	MAX	MIN	MAX		
Read Cycle Time	t _{RC}	70		100		ns	
Access Time	t _{ACC}		70		100	ns	
$\overline{\text{OE}}$ to Output Valid	t _{OE}		35		50	ns	
$\overline{\text{CE}}$ to Output Valid	t _{CO}		70		100	ns	
$\overline{\text{OE}}$ or $\overline{\text{CE}}$ to Output Active	t _{COE}	5		5		ns	5
Output High Z from Deselection	t _{OD}		25		35	ns	5
Output Hold from Address Change	t _{OH}	5		5		ns	
Write Cycle Time	t _{WC}	70		100		ns	
Write Pulse Width	t _{WP}	55		75		ns	3
Address Setup time	t _{AW}	0		0		ns	
Write Recovery Time	t _{WR1} t _{WR2}	5 15		5 15		ns ns	12 13
Output High Z from $\overline{\text{WE}}$	t _{ODW}		25		35	ns	5
Output Active from $\overline{\text{WE}}$	t _{OEW}	5		5		ns	5
Data Setup Time	t _{DS}	30		40		ns	4
Data Hold Time	t _{DH1} t _{DH2}	0 10		0 10		ns ns	12 13

READ CYCLE

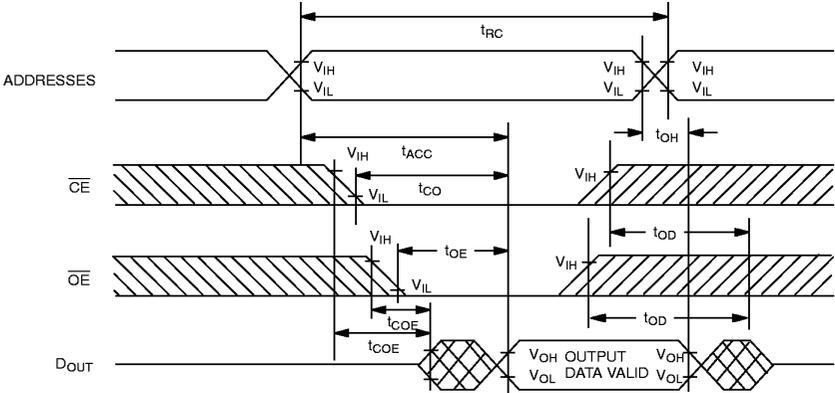

SEE NOTE 1

WRITE CYCLE 1

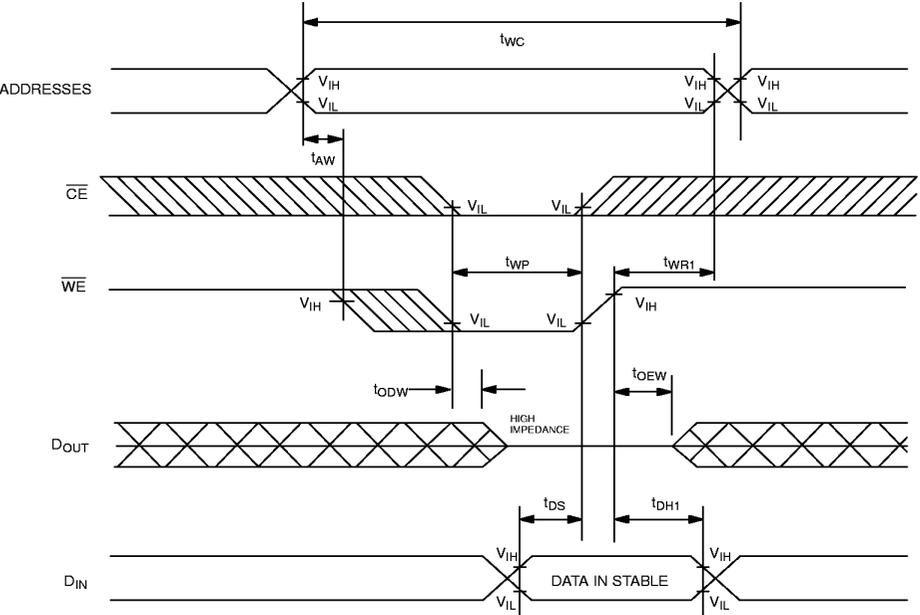

SEE NOTES 2, 3, 4, 6, 7, 8 and 12

WRITE CYCLE 2

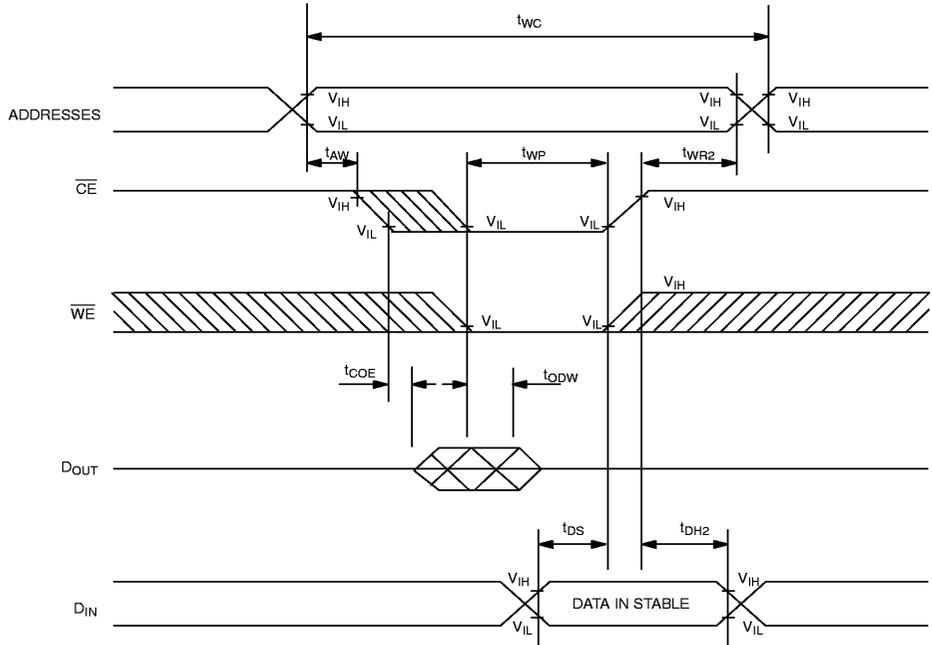

SEE NOTES 2, 3, 4, 6, 7, 8 and 13

POWER-DOWN/POWER-UP CONDITION

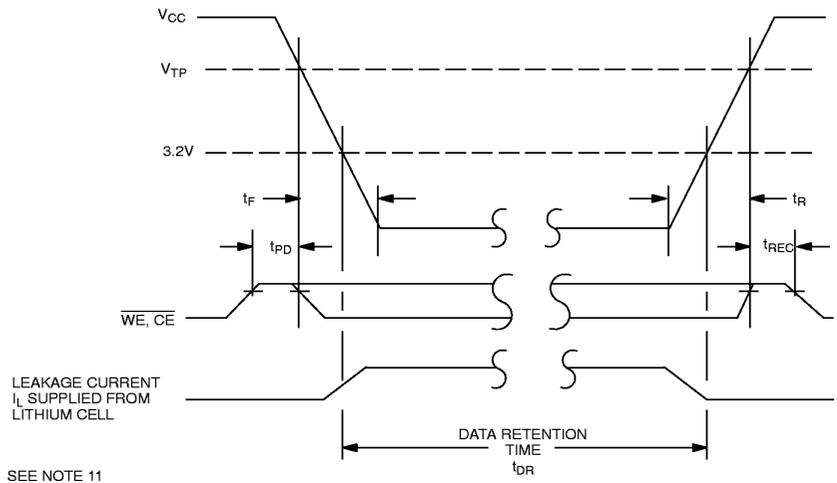

SEE NOTE 11

POWER-DOWN/POWER-UP TIMING(t_A: See Note 10)

PARAMETER	SYMBOL	MIN	TYP	MAX	UNITS	NOTES
\overline{CE} , \overline{WE} at V _{IH} before Power-Down	t _{PD}	0			μs	11
V _{CC} slew from V _{TP} to 0V	t _F	300			μs	
V _{CC} slew from 0V to V _{TP}	t _R	300			μs	
\overline{CE} , \overline{WE} at V _{IH} after Power-Up	t _{REC}	2		125	ms	

(t_A = 25°C)

PARAMETER	SYMBOL	MIN	TYP	MAX	UNITS	NOTES
Expected Data Retention Time	t _{DR}	10			years	9

WARNING:

Under no circumstance are negative undershoots, of any amplitude, allowed when device is in battery backup mode.

NOTES:

- \overline{WE} is high for a Read Cycle.
- $\overline{OE} = V_{IH}$ or V_{IL} . If $\overline{OE} = V_{IH}$ during write cycle, the output buffers remain in a high impedance state.
- t_{WP} is specified as the logical AND of \overline{CE} and \overline{WE} . t_{WP} is measured from the latter of \overline{CE} or \overline{WE} going low to the earlier of \overline{CE} or \overline{WE} going high.
- t_{DS} is measured from the earlier of \overline{CE} or \overline{WE} going high.
- These parameters are sampled with a 5 pF load and are not 100% tested.
- If the \overline{CE} low transition occurs simultaneously with or later than the \overline{WE} low transition in Write Cycle 1, the output buffers remain in a high impedance state during this period.
- If the \overline{CE} high transition occurs prior to or simultaneously with the \overline{WE} high transition, the output buffers remain in high impedance state during this period.
- If \overline{WE} is low or the \overline{WE} low transition occurs prior to or simultaneously with the \overline{CE} low transition, the output buffers remain in a high impedance state during this period.
- Each DS1245 has a built-in switch that disconnects the lithium source until V_{CC} is first applied by the user. The expected t_{DR} is defined as accumulative time in the absence of V_{CC} starting from the time power is first applied by the user.
- All AC and DC electrical characteristics are valid over the full operating temperature range. For commercial products, this range is 0°C to 70°C. For industrial products (IND), this range is -40°C to +85°C.
- In a power down condition the voltage on any pin may not exceed the voltage on V_{CC}.
- t_{WR1}, t_{DH1} are measured from \overline{WE} going high.
- t_{WR2}, t_{DH2} are measured from \overline{CE} going high.

DC TEST CONDITIONS

Outputs Open
Cycle = 200 ns for operating current
All voltages are referenced to ground

AC TEST CONDITIONS

Output Load: 100 pF + 1TTL Gate
Input Pulse Levels: 0 – 3.0V
Timing Measurement Reference Levels
Input: 1.5V
Output: 1.5V
Input pulse Rise and Fall Times: 5 ns

ORDERING INFORMATION

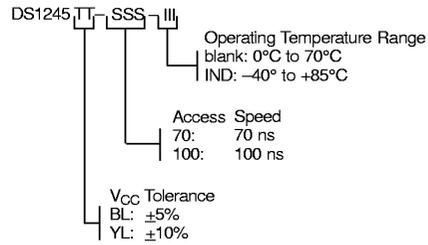

DS1245YL/BL 34-PIN LOW PROFILE MOFULE (LPM)

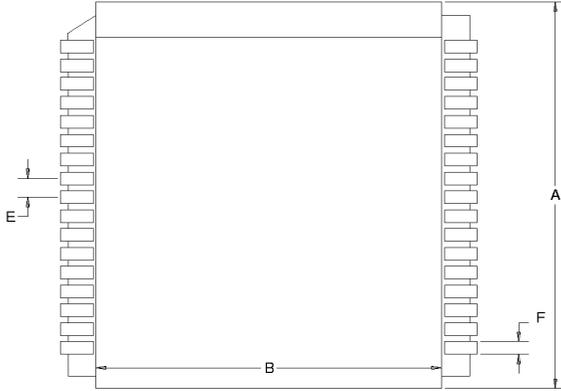

PKG	INCHES	
	MIN	MAX
A	0.955	0.980
B	0.840	0.855
C	0.230	0.250
D	0.975	0.995
E	0.050 BSC	
F	0.015	0.025

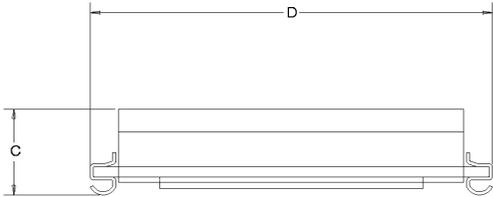

Dallas Semiconductor Low Profile Modules must be inserted into 68-pin PLCC sockets for proper operation. Direct surface-mounting of these products by reflow soldering will destroy internal lithium batteries.

For recommended PLCC sockets, contact the Dallas Semiconductor factory.