

S Series Unsealed, SE Series Sealed, Through-Hole and Surface Mount

Product Facts

- Sealed or Unsealed
- Straight or Right-Angle
- Through-hole or Surface-mount
- Bulk or Tape-and-Reel packaged
- Compact size
- Double-pole function in a single-pole body
- PC retention feature
- High reliability contact system
- Epoxy sealed base
- Robust actuator for easy actuation
- Non-shorting (break-before-make)

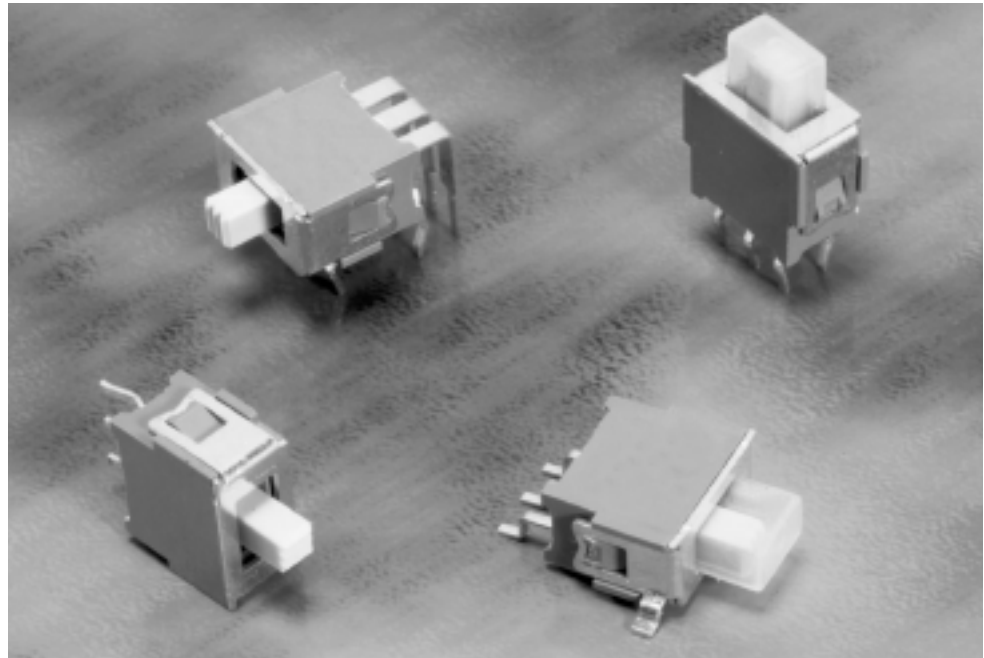

Switch, Slide, Surface Mount - SE1 SMT (Shown w/Boot)

Electrical Characteristics

Contact rating: .4 VA @ 20 VDC Max.
50mA 48V AC/DC
Min. 1 micro A 20 mV AC/DC

Initial Contact Resistance: less than 50 milliohms

Final Contact Resistance: 100 milliohms max.

Insulation Resistance: 500 Megaohms @ 250 VDC

Dielectric Strength: 500 VAC between terminals and ground

Mechanical

Mechanical Life: Up to 10,000 cycles @ max. load

Actuation Force: 70 to 500 grams

Materials and Finish

Terminals: Tin-lead over nickel-plated phosphor bronze

Contacts: Gold over nickel plated phosphor bronze

Frame: Tin over nickel plated brass

Case, Actuator, Plunger, Terminal Board: UL 94V-0 glass-filled Polyamide

Actuator Boot: Silicon Rubber

Standards & Specs

Sealed switch per IP 67

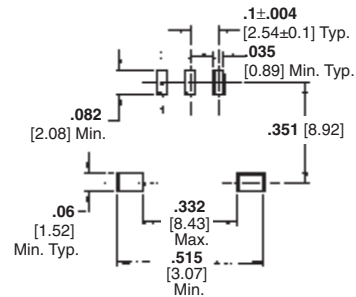
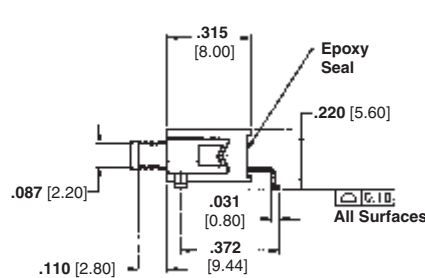
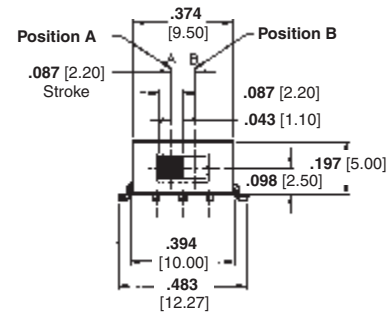
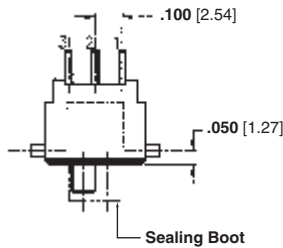

Recommended P.C.B. Pad Layout

SMT-Sealed Part Numbers

| Tyco Electronics | Alcoswitch | Function |
|------------------|------------|------------|
| 1571004-1 | SE1GSMT | On-Off |
| 1571004-2 | SE1EGSMT | On-Off-On |
| 1571004-3 | SE1DGSMT | On-None-On |

Tape & Reel Package

| Tyco Electronics | Alcoswitch | Function |
|------------------|------------|------------|
| 1571004-4 | SE1GSMTTR | On-Off |
| 1571004-5 | SE1EGSMTTR | On-Off-On |
| 1571004-6 | SE1DGSMTTR | On-None-On |

B
S/SE Series

Switch, Slide, PC Tail, S/SE GPC (Shown w/o Boot)

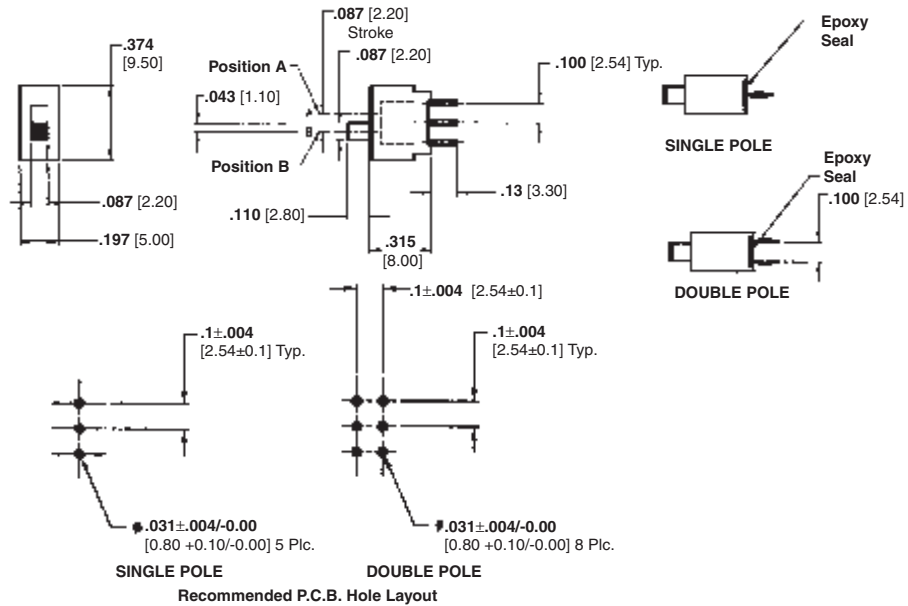

Sealed Part Numbers w/Boot

| Tyco Electronics | Alcoswitch | Function |
|------------------|------------|------------|
| 1437574-9 | SE1DGPC | On-None-On |
| 1-1437574-4 | SE1EGPC | On-Off-On |
| 1-1437574-6 | SE2DGPC | On-None-On |
| 2-1437574-0 | SE2EGPC | On-Off-On |

Unsealed Part Numbers w/o Boot

| Tyco Electronics | Alcoswitch | Function |
|------------------|------------|------------|
| 1571005-1 | S1DGPC | On-None-On |
| 1571005-2 | S1EGPC | On-Off-On |
| 1571005-3 | S2DGPC | On-None-On |
| 1571005-4 | S2EGPC | On-Off-On |

Switch, Slide, Right Angle, S/SE GRA (Shown w/o Boot)

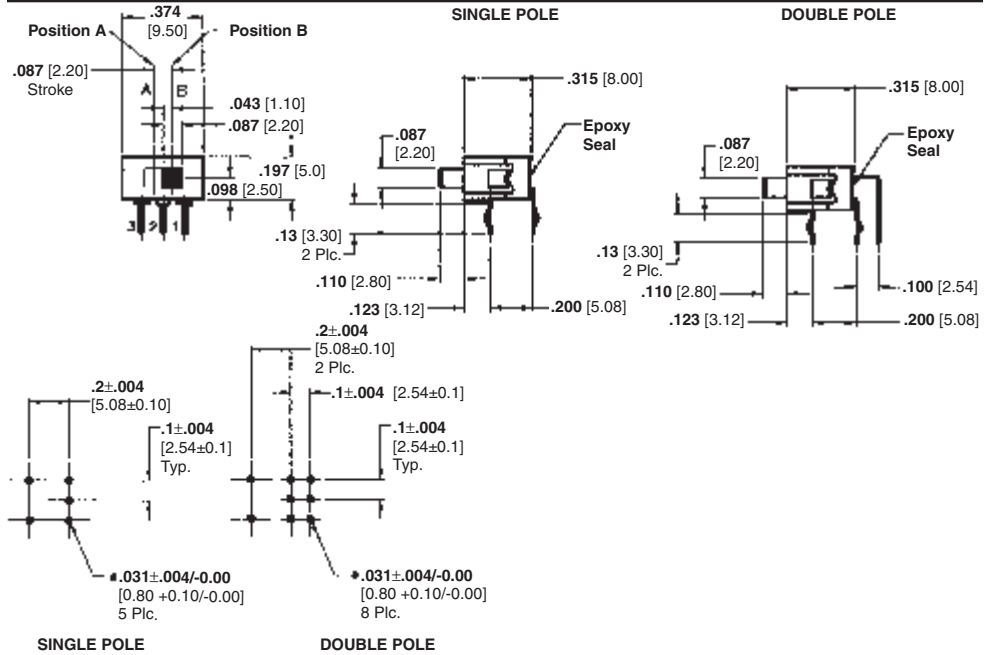

Sealed Part Numbers w/Boot

| Tyco Electronics | Alcoswitch | Function |
|------------------|------------|------------|
| 1-1437574-1 | SE1DGRA | On-None-On |
| 1-1437574-5 | SE1EGRA | On-Off-On |
| 1-1437574-8 | SE2DGRA | On-None-On |
| 2-1437574-1 | SE2EGRA | On-Off-On |

Unsealed Part Numbers w/o Boot

| Tyco Electronics | Alcoswitch | Function |
|------------------|------------|------------|
| 1571006-1 | S1DGRA | On-None-On |
| 1571006-2 | S1EGRA | On-Off-On |
| 1571006-3 | S2DGRA | On-None-On |
| 1571006-4 | S2EGRA | On-Off-On |

Slide Switches, Miniature, Low Profile, Economy Grade

MATERIAL SPECIFICATIONS:

ContactsSilver clad copper alloy
 Case MaterialSteel zinc plated
 Actuator MaterialPolyester (UL 94HB)
 Terminal SealEpoxy
 Terminals/Fixed ContactsSilver plate copper alloy

ENVIRONMENTAL SPECIFICATIONS:

Operating Temperature..... -5°F to 140°F (-15°C to +60°C)
 Storage Temperature.....-4°F to +158°F (-20°C to +70°C)
 Solder Heat ResistanceMIL-STD-202, Method 210

TYPICAL PERFORMANCE CHARACTERISTICS:

Contact Rating300 mA @ 125 VAC
 Initial Contact Resistance20 Milliohms max.
 Contact TimingMake-before-break
 Insulation Resistance100 Megohms min. @ 500 VDC
 Dielectric Strength500 VAC
 Actuation Force250 Grams, +150 Grams, -100 Grams
 Actuator Travel.....0.098" (2.49)
 Life ExpectancyUp to 10,000 Cycles

NOTICE: Bifurcated contact produces double wiping, self-cleaning contacts.

P. C. HOLE LAYOUT

| Part Number | | | |
|------------------|------------|---------|----------------|
| Tyco Electronics | Alcoswitch | Plating | Mounting Style |
| 5-1437577-8 | STS121PC | Silver | Upright |

SPDT

STS121PC

P. C. HOLE LAYOUT

| Part Number | | | |
|------------------|------------|---------|----------------|
| Tyco Electronics | Alcoswitch | Plating | Mounting Style |
| 5-1437577-9 | STS121RA | Silver | Right Angle |

SPDT

STS121RA

P. C. HOLE LAYOUT

| Part Number | | | |
|------------------|------------|---------|----------------|
| Tyco Electronics | Alcoswitch | Plating | Mounting Style |
| 6-1437577-2 | STS131PC | Silver | Upright |

SP3T

STS131PC

P. C. HOLE LAYOUT

| Part Number | | | |
|------------------|------------|---------|----------------|
| Tyco Electronics | Alcoswitch | Plating | Mounting Style |
| 6-1437577-3 | STS131RA | Silver | Right Angle |

SP3T

STS131RA

Slide Switches, Miniature, Low Profile, Economy Grade

SEE PAGE B13 FOR PRODUCT SPECIFICATIONS

SP3T



STS1300PC

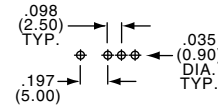
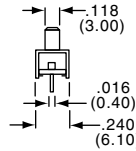
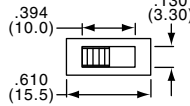
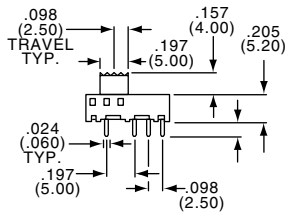

P. C. HOLE LAYOUT

SP3T



STS1300RA

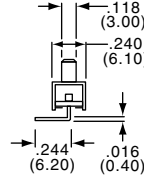
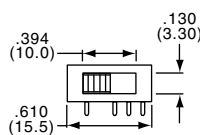

| Part Number | | | |
|------------------|------------|---------|----------------|
| Tyco Electronics | Alcoswitch | Plating | Mounting Style |
| 6-1437577-0 | STS1300PC | Silver | Upright |
| 6-1437577-1 | STS1300RA | Silver | Right Angle |

SP4T



STS1400PC

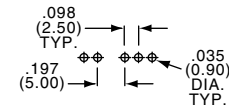
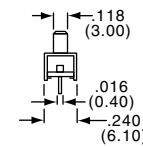
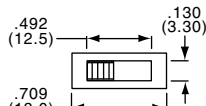
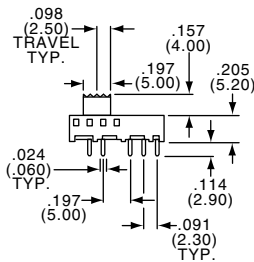

P. C. HOLE LAYOUT

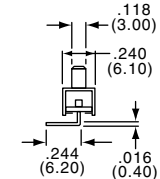
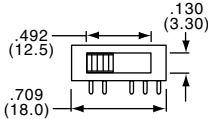

| Part Number | | | |
|------------------|------------|---------|----------------|
| Tyco Electronics | Alcoswitch | Plating | Mounting Style |
| 6-1437577-5 | STS1400PC | Silver | Upright |
| 6-1437577-6 | STS1400RA | Silver | Right Angle |

SP4T



STS141RA

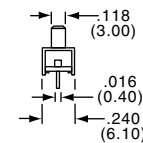
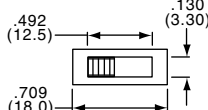
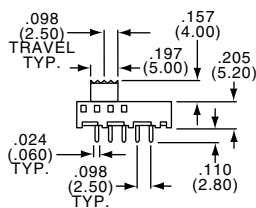

P. C. HOLE LAYOUT

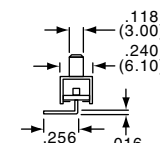
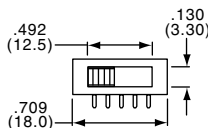

| Part Number | | | |
|------------------|------------|---------|----------------|
| Tyco Electronics | Alcoswitch | Plating | Mounting Style |
| 6-1437577-7 | STS141PC | Silver | Upright |
| 6-1437577-8 | STS141RA | Silver | Right Angle |

Slide Switches, Miniature, Low Profile, Economy Grade

SEE PAGE B13 FOR PRODUCT SPECIFICATIONS

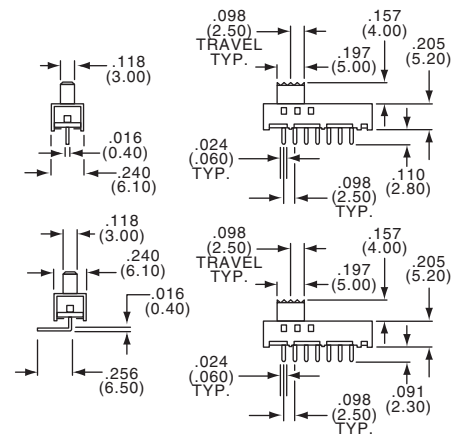
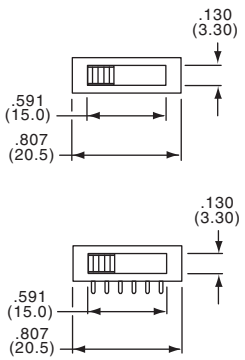
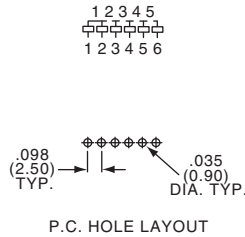

| Part Number | | | |
|------------------|------------|---------|----------------|
| Tyco Electronics | Alcoswitch | Plating | Mounting Style |
| 6-1437577-9 | STS151PC | Silver | Upright |
| 7-1437577-0 | STS151RA | Silver | Right Angle |

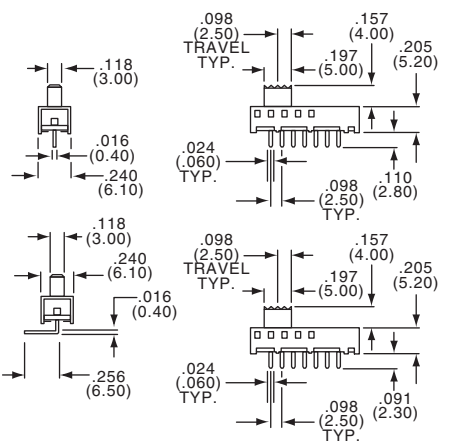
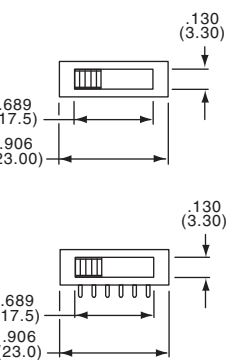
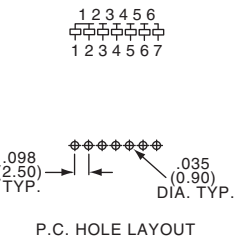

| Part Number | | | |
|------------------|------------|---------|----------------|
| Tyco Electronics | Alcoswitch | Plating | Mounting Style |
| 7-1437577-1 | STS161PC | Silver | Upright |
| 7-1437577-2 | STS161RA | Silver | Right Angle |

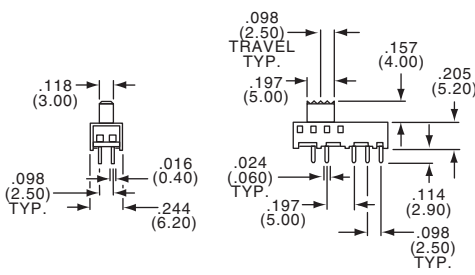
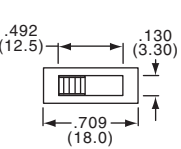
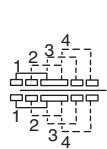
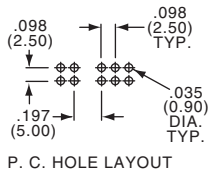
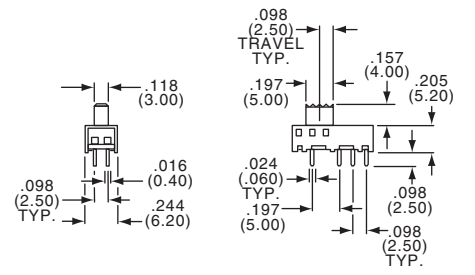
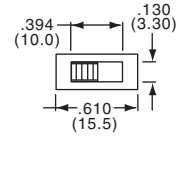
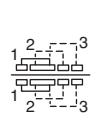
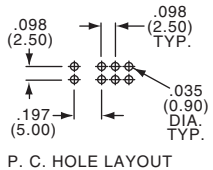

| Part Number | | | | |
|------------------|------------|---------|----------------|---------|
| Tyco Electronics | Alcoswitch | Plating | Mounting Style | |
| 7-1437577-4 | STS2300PC | DP3T | Silver | Upright |
| 7-1437577-6 | STS2400PC | DP4T | Silver | Upright |