

SP1003 Series - 30pF 30kV Unidirectional Discrete TVS  **AUTOMOTIVE GRADE**  **HF**  **RoHS**  **Pb**  **GREEN**

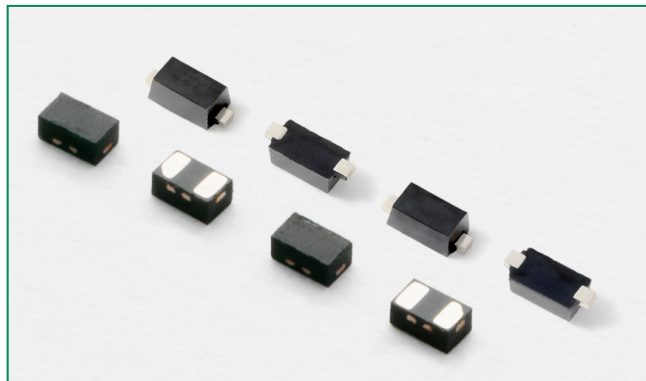

Description

Zener diodes fabricated in a proprietary silicon avalanche technology protect each I/O pin to provide a high level of protection for electronic equipment that may experience destructive electrostatic discharges (ESD). These robust diodes can safely absorb repetitive ESD strikes at $\pm 30\text{kV}$ (contact discharge, IEC 61000-4-2) without performance degradation. Additionally, each diode can safely dissipate 7A of 8/20 μs surge current (IEC61000-4-5) with very low clamping voltages.

Features

- RoHS compliant, Halogen-free and Lead-free
- ESD, IEC 61000-4-2, $\pm 30\text{kV}$ contact, $\pm 30\text{kV}$ air
- EFT, IEC 61000-4-4, 40A (5/50ns)
- Lightning, IEC 61000-4-5 2nd edition, 7A (8/20 μs)
- Low leakage current of 100nA (MAX) at 5V
- Tiny SOD723/ SOD882 (JEDEC MO-236) package saves board space
- Fits solder footprint of industry standard 0402 (1005) devices
- AEC-Q101 qualified (SOD882 package)
- Moisture Sensitivity Level (MSL Level-1)

Pinout

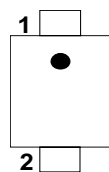

SOD723

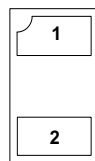

SOD882
(AEC-Q101 qualified)

Functional Block Diagram



Applications

- Mobile phones
- Smart phones
- Tablets
- Portable navigation devices
- Digital cameras
- Portable medical devices
- Wearable Technology

Additional Information



Application Example

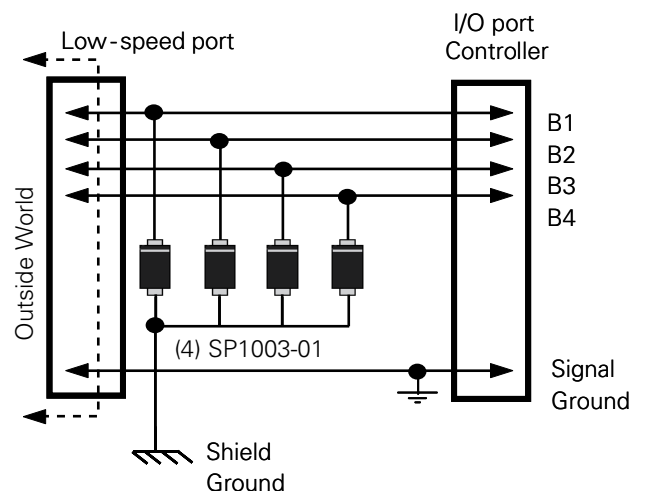

Life Support Note:
Not Intended for Use in Life Support or Life Saving Applications
The products shown herein are not designed for use in life sustaining or life saving applications unless otherwise expressly indicated.

Absolute Maximum Ratings

Symbol	Parameter	Value	Units
I_{PP}	Peak Pulse Current ($t_p=8/20\mu s$)	7.0	A
T_{OP}	Operating Temperature	-40 to 125	°C
T_{STOR}	Storage Temperature	-55 to 150	°C

CAUTION: Stresses above those listed in "Absolute Maximum Ratings" may cause permanent damage to the device. This is a stress only rating and operation of the device at these or any other conditions above those indicated in the operational sections of this specification is not implied.

Thermal Information

Parameter	Rating	Units
Storage Temperature Range	-55 to 150	°C
Maximum Junction Temperature	150	°C
Maximum Lead Temperature (Soldering 20-40s)	260	°C

Electrical Characteristics ($T_{OP}=25^\circ C$)

Parameter	Symbol	Test Conditions	Min	Typ	Max	Units
Forward Voltage Drop	V_F	$I_F = 10mA$		0.8	1.2	V
Reverse Voltage Drop	V_R	$I_R = 1mA$	6.0	7.8	8.5	V
Reverse Standoff Voltage	V_{RWM}	$I_R \leq 1\mu A$			5.0	V
Reverse Leakage Current	I_{LEAK}	$V_R = 5V$			100	nA
Clamp Voltage ¹	V_C	$I_{pp} = 6A$ $t_p = 8/20\mu s$		11.4		V
		$I_{pp} = 7A$ $t_p = 8/20\mu s$		12.0		V
Dynamic Resistance	R_{DYN}	TLP; $t_p = 100ns$, 1/O to GND		0.25		Ω
ESD Withstand Voltage ¹	V_{ESD}	IEC61000-4-2 (Contact Discharge)		± 30		kV
		IEC61000-4-2 (Air Discharge)		± 30		kV
Diode Capacitance ¹	C_D	Reverse Bias=0V		30		pF

Note: ¹ Parameter is guaranteed by design and/or device characterization.

Capacitance vs. Reverse Bias

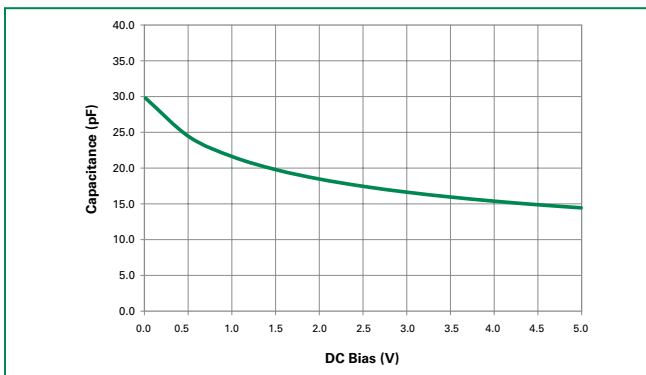

Clamping Voltage vs. I_{PP}

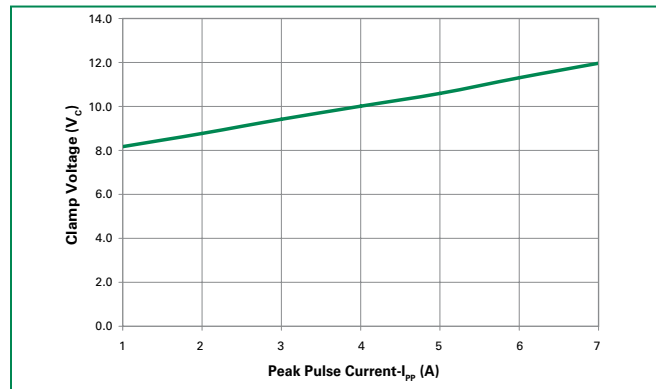

Transmission Line Pulsing (TLP) Plot

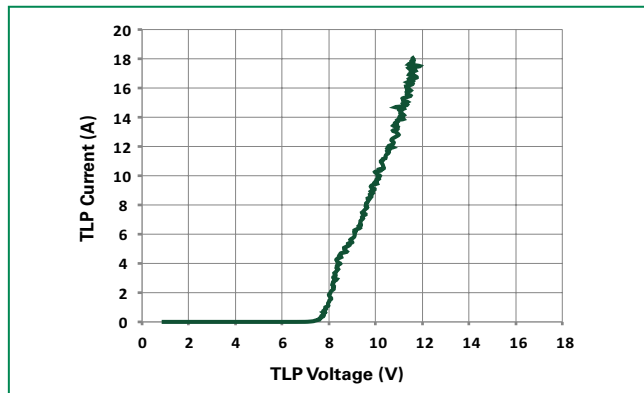

Leakage vs. Temperature

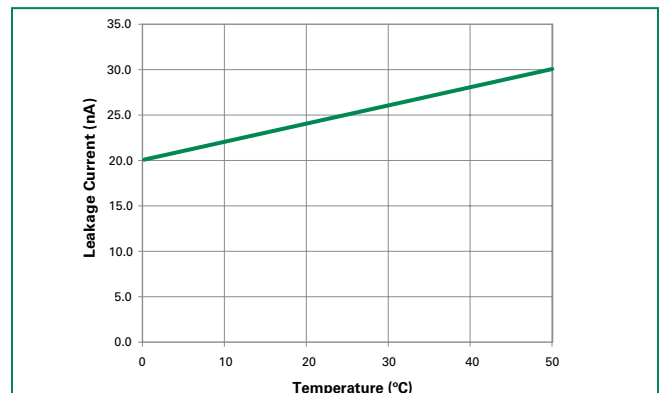

Pulse Waveform

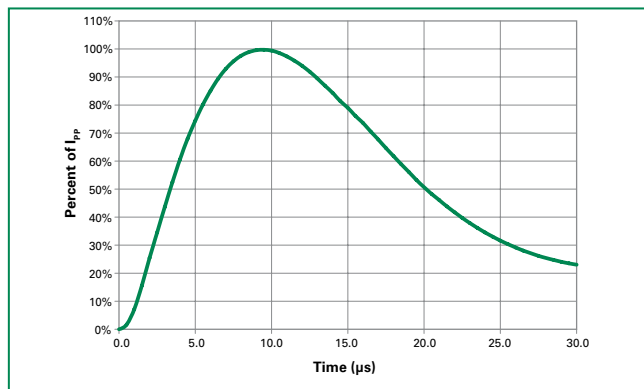

Soldering Parameters

Reflow Condition		Pb – Free assembly
Pre Heat	- Temperature Min ($T_{s(min)}$)	150°C
	- Temperature Max ($T_{s(max)}$)	200°C
	- Time (min to max) (t_s)	60 – 180 secs
Average ramp up rate (Liquidus) Temp (T_L) to peak		3°C/second max
$T_{s(max)}$ to T_L - Ramp-up Rate		3°C/second max
Reflow	- Temperature (T_L) (Liquidus)	217°C
	- Temperature (t_l)	60 – 150 seconds
Peak Temperature (T_p)		260 $^{+0/-5}$ °C
Time within 5°C of actual peak Temperature (t_p)		20 – 40 seconds
Ramp-down Rate		6°C/second max
Time 25°C to peak Temperature (T_p)		8 minutes Max.
Do not exceed		260°C

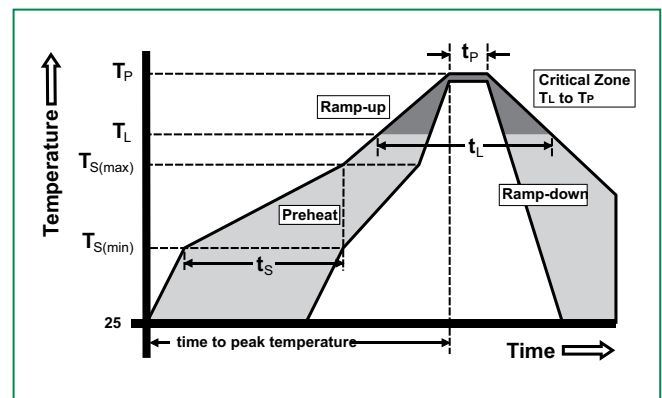

Part Numbering System

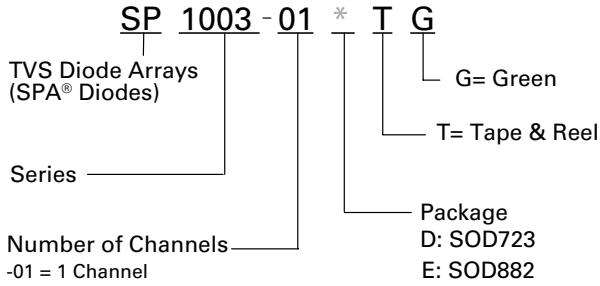

Part Marking System

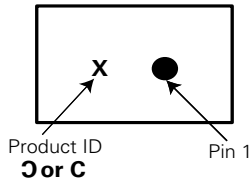

Product Characteristics

Lead Plating	Pre-Plated Frame or Matte Tin
Lead Material	Copper Alloy
Lead Coplanarity	0.0004 inches (0.102mm)
Substitute Material	Silicon
Body Material	Molded Epoxy
Flammability	UL 94 V-0

- Notes :
1. All dimensions are in millimeters
 2. Dimensions include solder plating.
 3. Dimensions are exclusive of mold flash & metal burr.
 4. Blo is facing up for mold and facing down for trim/form, i.e. reverse trim/form.
 5. Package surface matte finish VDI 11-13.

Ordering Information

Part Number	Package	Marking	Min. Order Qty.
SP1003-01DTG	SOD723	J or C	8,000
SP1003-01ETG	SOD882	J or C	10,000

Package Dimensions — SOD723

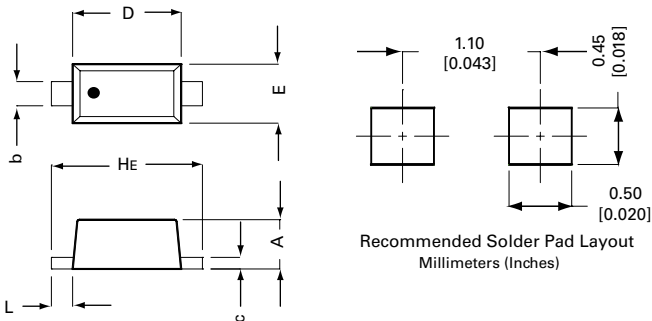

Symbol	SOD723			
	Millimeters		Inches	
	Min	Max	Min	Max
A	0.46	0.65	0.018	0.026
b	0.23	0.35	0.009	0.014
c	0.08	0.13	0.003	0.005
D	0.90	1.10	0.035	0.043
E	0.58	0.64	0.023	0.025
HE	1.37	1.47	0.054	0.058
L	0.15	0.25	0.006	0.010

Package Dimensions — SOD882

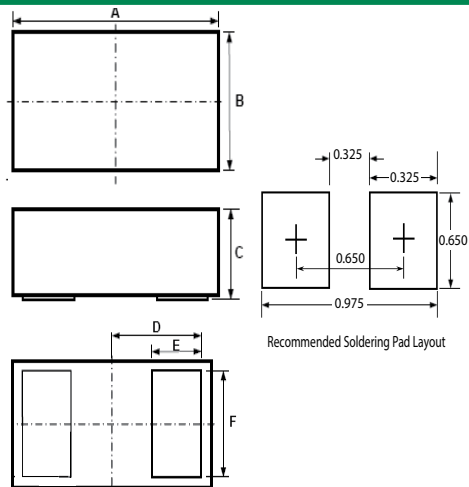

Symbol	Package	SOD882					
	JEDEC	MO-236					
		Millimeters			Inches		
		Min	Typ	Max	Min	Typ	Max
A		0.90	1.00	1.10	0.035	0.039	0.043
B		0.50	0.60	0.70	0.020	0.024	0.028
C		0.40	0.50	0.60	0.016	0.020	0.024
D		0.45			0.018		
E		0.20	0.25	0.35	0.008	0.010	0.012
F		0.45	0.50	0.55	0.018	0.020	0.022

Embossed Carrier Tape & Reel Specification – SOD723

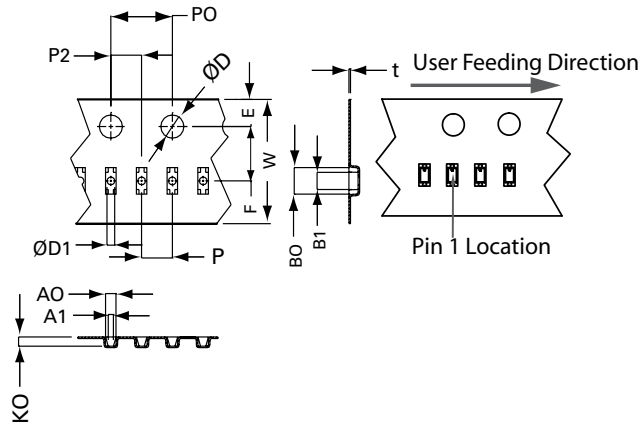

Symbol	Millimetres		Inches	
	Min	Max	Min	Max
E	1.65	1.85	0.064	0.072
F	3.40	3.60	0.134	0.142
D1	0.45	0.55	0.017	0.021
D	1.50	--	0.060	--
PO	3.90	4.10	0.153	0.161
10P0	40.0±0.20		1.570±0.010	
W	7.90	8.20	0.311	0.322
P2/P	1.90	2.10	0.074	0.082
AO	0.60	0.80	0.024	0.032
A1	0.33 REF		0.010 REF	
BO	1.61	1.81	0.063	0.071
B1	1.10 REF		0.040 REF	
KO	0.54	0.78	0.021	0.031
t	--	0.21	--	0.008

Embossed Carrier Tape & Reel Specification – SOD882

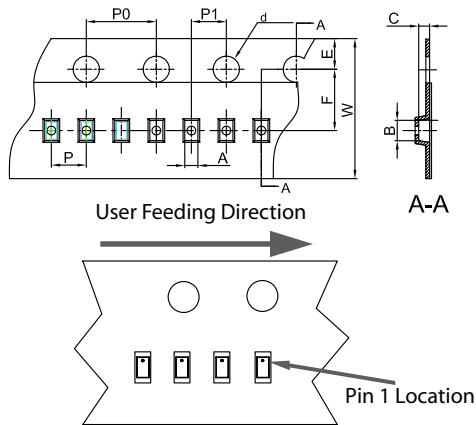

Symbol	Millimetres		Inches	
	Min	Max	Min	Max
A	0.65	0.70	0.026	0.028
B	1.10	1.20	0.043	0.047
C	0.50	0.60	0.020	0.024
dØ	1.40	1.60	0.055	0.063
E	1.65	1.85	0.065	0.073
F	3.40	3.60	0.134	0.142
P0	3.90	4.10	0.154	0.161
P	1.90	2.10	0.075	0.083
P1	1.90	2.10	0.075	0.083
W	7.90	8.10	0.311	0.319

Disclaimer Notice - Information furnished is believed to be accurate and reliable. However, users should independently evaluate the suitability of and test each product selected for their own applications. Littelfuse products are not designed for, and may not be used in, all applications. Read complete Disclaimer Notice at www.littelfuse.com/disclaimer-electronics.