

20W, Ultra wide input, isolated & regulated Dual output, DC/DC converter



Patent Protection RoHS



FEATURES

- Ultra wide input voltage range (4:1)
- Enhanced isolation, Isolation voltage: 3K VDC & 1.5K VAC
- Operating temperature range: -40°C to +85°C
- Input Under-voltage Protection, Output short circuit, over-current, over-voltage protection
- Low ripple & noise
- Meet EN50121-3-2 CISPR32/EN55032 CLASS A, without external components
- Meets requirements of railway standard EN50155
- Reverse voltage protection available with A2S(Chassis mounting) or A4S(35mm DIN-Rail mounting)
- Meets IEC60950, UL60950, EN60950 standards
- Meets requirements of railway standard EN50155
- International standard pin-out

URE1D_LD-20WR3 series are isolated 20W DC-DC products with 4:1 input voltage. Their feature efficiency up to 86%, 3000VDC & 1500VAC isolation with enhanced isolation, operating temperature of -40°C to +85°C, Input Under-voltage Protection, Output short circuit, over-current, over-voltage protection. Railway vehicle electronic equipment widely used in 72V, 96V and 110V.

Selection Guide

Certification	Part No. ①	Input Voltage (VDC)		Output		Efficiency ^④ (%Min./Typ.) @ Full Load	Max. Capacitive Load(μF) ^⑤
		Nominal ^② (Range)	Max. ^③	Output Voltage (VDC)	Output Current (mA)(Max./Min.)		
--	URE1D12LD-20WR3	110 (40-160)	170	±12	±833/0	83/85	680
	URE1D15LD-20WR3			±15	±667/0	84/86	470
	URE1D24LD-20WR3			±24	±417/0	84/86	220

Note:

- ① Series with suffix "H" are heat sink mounting; series with suffix "A2S" are chassis mounting, with suffix "A4S" are DIN-Rail mounting, for example URE1D12LD-20WR3A2S is chassis mounting of with heat sink, URE1D12LD-20WR3A4S is DIN-Rail mounting of without heat sink; If the application has a higher requirement for heat dissipation, you can choose modules with heat sink;
- ② A2S (wiring) and A4S (rail) Model due to input reverse polarity protection function, input voltage range the minimum value and starting voltage is higher than 1VDC DIP package;
- ③ Absolute maximum rating without damage on the converter, but it isn't recommended;
- ④ Efficiency is measured in nominal input voltage and rated output load; A2S (wiring) and A4S (rail) Model due to input reverse polarity protection, minimum efficiency greater than Min.-2 is qualified.
- ⑤ For the dual output modules, the capacitive loads of positive and negative outputs are the same.

Input Specifications

Item	Operating Conditions	Min.	Typ.	Max.	Unit
Input Current (full load / no-load)	Nominal input voltage	--	212/3	217/8	mA
Reflected Ripple Current	Nominal input voltage	--	25	--	
Surge Voltage (1sec. max.)		-0.7	--	180	VDC
Starting Voltage	100% load	--	--	40	
Shutdown Voltage		28	33	--	
Starting Time	Nominal input voltage & constant resistance load	--	10	--	ms
Input Filter		PI filter			
Hot Plug		Unavailable			
Ctrl*	Module switch on	Ctrl suspended or connected to TTL high level (3.5-12VDC)			
	Module switch off	Ctrl pin connected to GND or low level (0-1.2VDC)			
	Input current when switched off	--	2	7	mA

Note: * the voltage of Ctrl pin is relative to input pin GND.

Output Specifications

Item	Operating Conditions	Min.	Typ.	Max.	Unit	
Voltage Accuracy	0% -100% load	Positive output	--	±1	±2	%
		Negative output	--	±1	±3	
Line Regulation	Full load, the input voltage is from low voltage to high voltage	Positive output	--	±0.2	±0.5	
		Negative output	--	±0.5	±1	
Load Regulation*	5% -100% load	Positive output	--	±0.5	±1	
		Negative output	--	±0.5	±1.5	
Cross Regulation	Dual output, main output 50% load, Supplement output from 10% - 100% load	--	--	±5		
Transient Recovery Time	25% load step change, nominal input voltage	--	300	500	μs	
Transient Response Deviation		--	±3	±5	%	
Temperature Coefficient	Full load	--	±0.02	±0.03	%/°C	
Ripple & Noise **	20MHz bandwidth, 5% -100% load	--	50	100	mV p-p	
Over-voltage Protection	Input voltage range	110	--	160		
Over-current Protection		120	--	210	%Io	
Short circuit Protection		Continuous, self-recovery				

Note: *When testing from 0% -100%load working conditions, load regulation index of ±5%;
** 0%-5% load ripple&Noise is no more than 5%Vo.Ripple and noise are measured by "parallel cable" method, please see DC-DC Converter Application Notes for specific operation.

General Specifications

Item	Operating Conditions	Min.	Typ.	Max.	Unit
Insulation Voltage	Input-output, with the test time of 1 minute and the leak current lower than 1mA	3000	--	--	VDC
	Input/output-casing, with the test time of 1 minute and the leak current lower than 1mA	1500	--	--	VDC
	Input-output, with the test time of 1 minute and the leak current lower than 5mA	1500	--	--	VAC
Insulation Resistance	Input-output, isolation voltage 500VDC	1000	--	--	MΩ
Isolation Capacitance	Input-output, 100KHz/0.1V	--	2200	--	pF
Operating Temperature	see Fig. 1	-40	--	+85	°C
Storage Temperature		-55	--	+125	
Storage Humidity	Non-condensing	5	--	95	%RH
Pin Welding Resistance Temperature	Welding spot is 1.5mm away from the casing, 10 seconds	--	--	300	°C
Switching Frequency*	PWM mode	--	300	--	KHz
Vibration		IEC 61373 car body 1 B mold			
MTBF	MIL-HDBK-217F@25°C	1000	--	--	K hours

Note: * This series of products using reduced frequency technology, the switching frequency is test value of full load,When the load is reduced to below 50%, the switching frequency decreases with decreasing load.

Physical Specifications

Casing Material	Aluminum alloy				
Package Dimensions	Without heat sink	Horizontal package		50.80*25.40*11.80mm	
		A2S wiring package		76.00*31.50*21.20 mm	
		A4S rail package		76.00*31.50*25.80 mm	
	With heat sink	Horizontal package		51.40*26.20*16.50mm	
		A2S wiring package		76.00*31.50*25.30 mm	
		A4S rail package		76.00*31.50*29.90 mm	
Weight	Without heat sink	Horizontal package/A2S wiring package/A4S rail package			26g/48g/68g(Typ.)
	With heat sink	Horizontal package/A2S wiring package/A4S rail package			34g/56g/76g(Typ.)
Cooling Method	Free air convection				

EMC Specifications (EN60950)

EMI	CE	CISPR32/EN55032	CLASS A(without external components)/CLASS B(see Fig. 5 for recommended circuit)	
	RE	CISPR32/EN55032	CLASS A(without external components)/CLASS B (see Fig.5 for recommended circuit)	
EMS	ESD	IEC/EN61000-4-2	Contact ±6KV/Air ±8KV	perf. Criteria B
	RS	IEC/EN61000-4-3	20V/m	perf. Criteria A
	EFT	IEC/EN61000-4-4	±4KV (see Fig.3 or Fig.4 for recommended circuit)	perf. Criteria B
	Surge	IEC/EN61000-4-5	line to line ±2KV (2Ω 18uF see Fig.3 for recommended circuit) line to ground ±4KV (12Ω 9uF see Fig.3 for recommended circuit)	perf. Criteria B
	CS	IEC/EN61000-4-6	10 Vr.m.s	perf. Criteria A

EMC Specifications (EN50155)

EMI	CE	EN50121-3-2	150kHz-500kHz 99dBuV (see Fig.5 for recommended circuit)	
	RE	EN55016-2-1	500kHz-30MHz 93dBuV	
EMS	ESD	EN50121-3-2	Contact ±6KV/Air ±8KV	perf. Criteria B
	RS	EN50121-3-2	20V/m	perf. Criteria A
	EFT	EN50121-3-2	±2kV 5/50ns 5kHz (see Fig.3 or Fig.4 for recommended circuit)	perf. Criteria A
	Surge	EN50121-3-2	line to line ±1KV (42Ω 0.5uF see Fig.4 for recommended circuit)	perf. Criteria B
	CS	EN50121-3-2	0.15MHz-80MHz 10 Vr.m.s	perf. Criteria A

Product Characteristic Curve

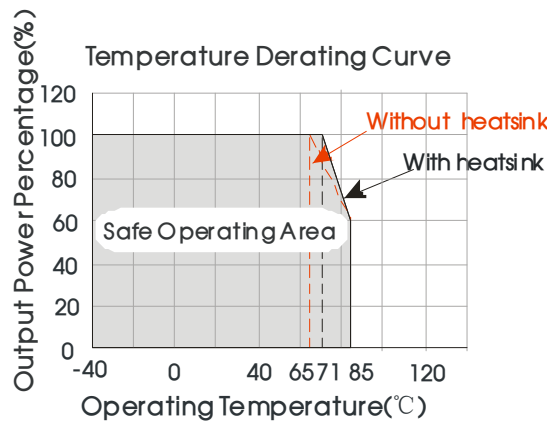
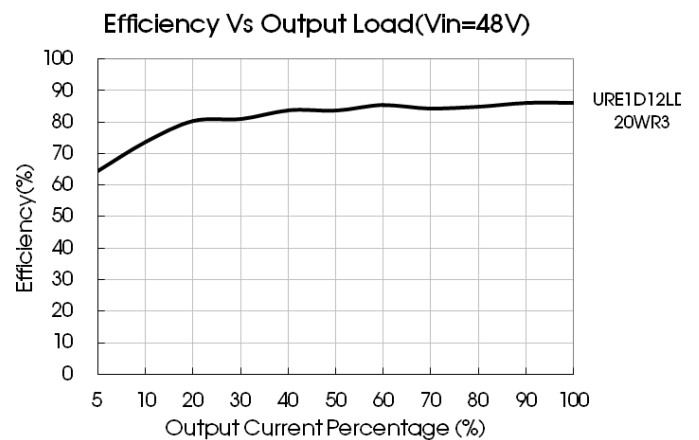
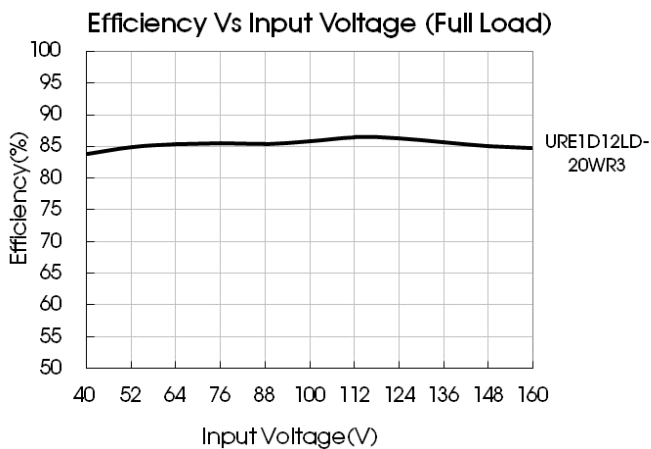
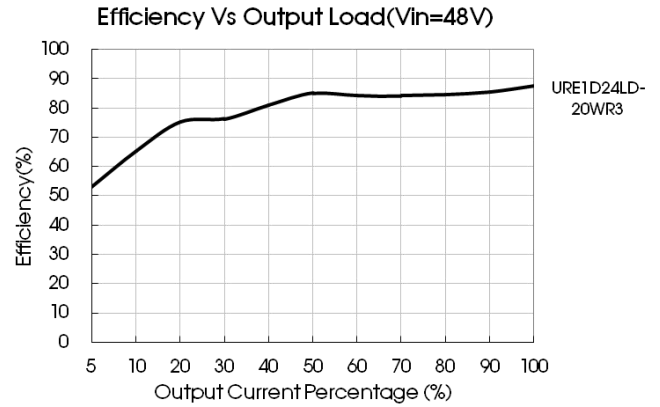
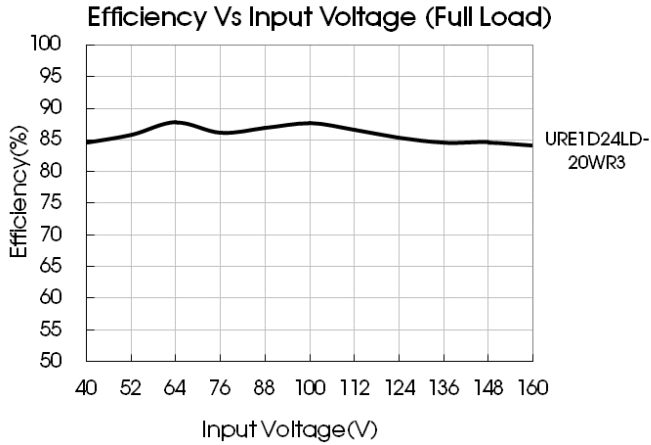

Fig. 1





Design Reference

1. Typical application

All the DC/DC converters of this series are tested according to the recommended circuit (see Fig. 2) before delivery. If it is required to further reduce input and output ripple, properly increase the input & output of additional capacitors C_{in} and C_{out} or select capacitors of low equivalent impedance provided that the capacitance is no larger than the max. capacitive load of the product.

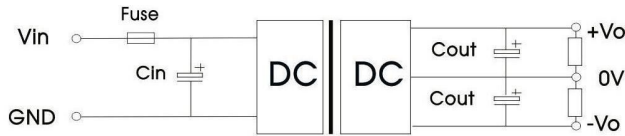

Fig. 2

Vout(VDC)	Fuse	Cin	Cout
$\pm 12/\pm 15$	2A, slow blow	10 μ F - 47 μ F	220 μ F
± 24			100 μ F

2. EMC module solution-recommended circuit

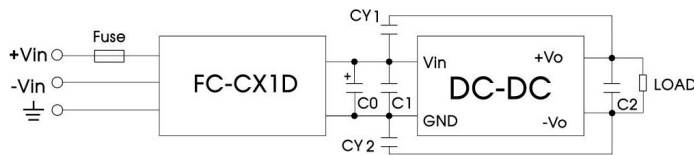

Fig. 3

Fig. 3 Parameter description

Output voltage	$\pm 12V$	$\pm 15V$	$\pm 24V$
FUSE	Choose according to actual input current		
FC-CX1D	FC-CX1D is the EMC auxiliary component of our company. Input voltage range: 40V-160V		
C0	100 μ F/200V		
C1	47 μ F/200V		
C2	220 μ F/25V	100 μ F/35V	
CY1、CY2	1000pF/400VAC		

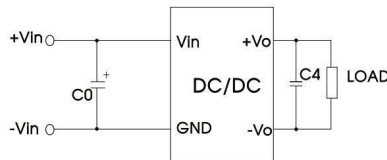

Fig. 4

Fig. 4/ Fig. 5 Parameter description

Output voltage	$\pm 12V$	$\pm 15V$	$\pm 24V$
C0	100 μ F/200V		
C1、C2	0.22 μ F/250V		
C3	47 μ F/200V		
LCM1、LCM2	30mH (common mode inductance)		
CY1、CY2、CY3、CY4	1000pF/400VAC		
C4	220 μ F/25V	100 μ F/35V	

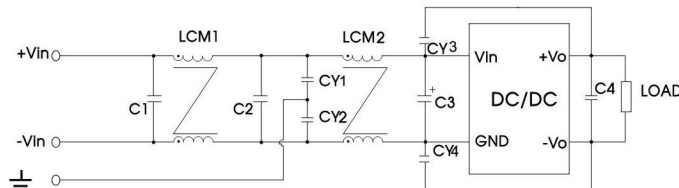
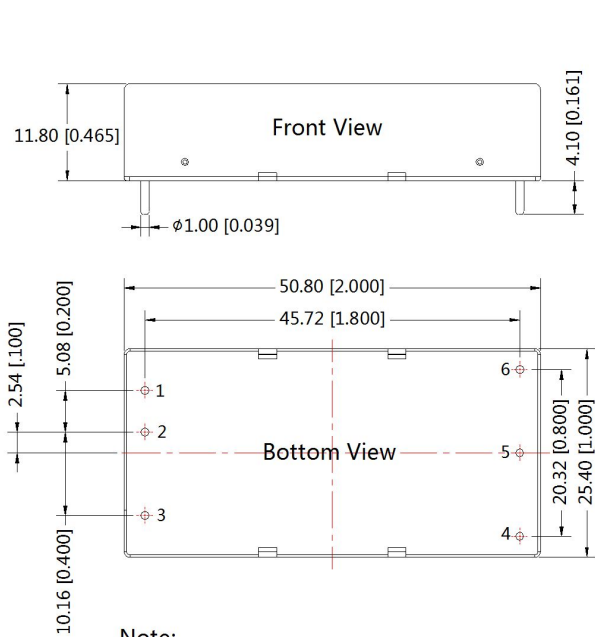

Fig. 5

3. It is not allowed to connect modules output in parallel to enlarge the power

4. For more information please find DC-DC converter application notes on www.mornsun-power.com

Horizontal Package (without heat sink) Dimensions and Recommended Layout



Note:
Unit: mm[inch]
Pin diameter tolerances: $\pm 0.10[\pm 0.004]$
General tolerances: $\pm 0.50[\pm 0.020]$

THIRD ANGLE PROJECTION

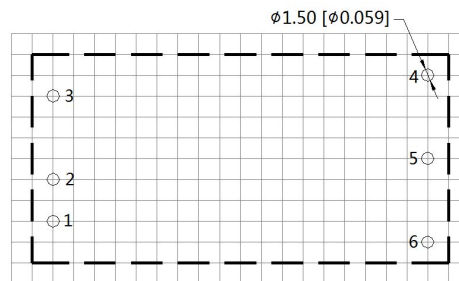

Note : Grid 2.54*2.54mm

Pin-Out	
Pin	Dual
1	Vin
2	GND
3	Ctrl
4	-Vo
5	0V
6	+Vo

Horizontal Package (with heat sink) Dimensions

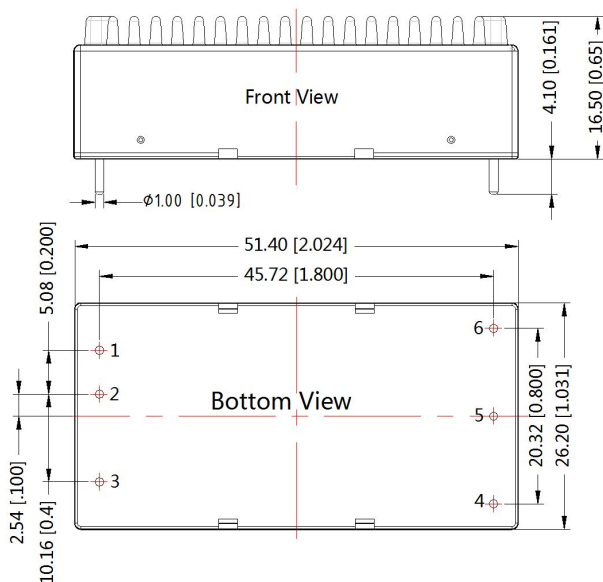

Pin-Out	
Pin	Dual
1	Vin
2	GND
3	Ctrl
4	-Vo
5	0V
6	+Vo

Note:
Unit: mm[inch]
General tolerances: $\pm 0.50[\pm 0.020]$

THIRD ANGLE PROJECTION

URB1D_LD-20WR3A2S (without heatsink) Dimensions

THIRD ANGLE PROJECTION 

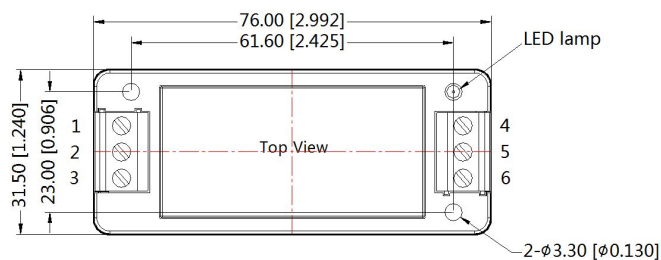

Pin-Out						
Pin	1	2	3	4	5	6
Dual	Ctrl	GND	Vin	-Vo	0V	+Vo

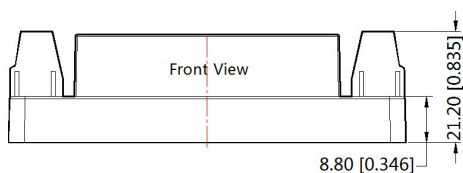

Note:
Unit: mm[inch]
Wire range: 24 - 12 AWG
Tightening torque: Max 0.4 N·m
General tolerances: ±0.50[±0.020]

URB1D_LD-20WHR3A2S (with heatsink) Dimensions

THIRD ANGLE PROJECTION 

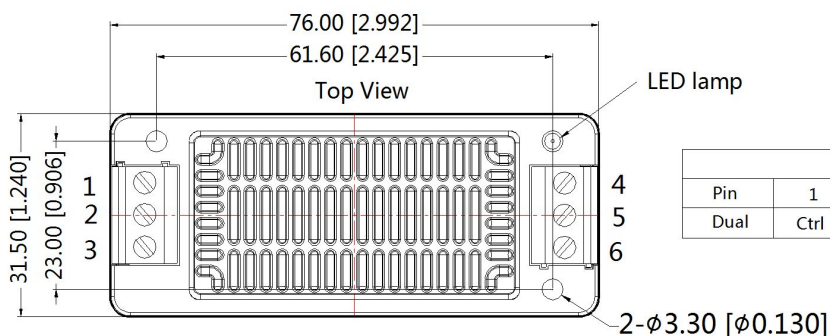

Pin-Out						
Pin	1	2	3	4	5	6
Dual	Ctrl	GND	Vin	-Vo	0V	+Vo

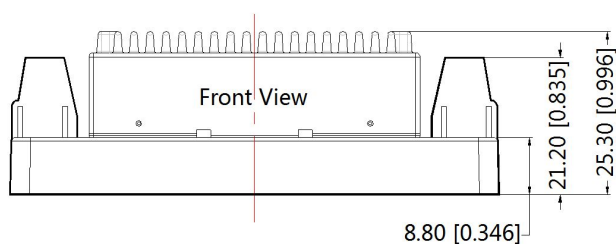

Note:
Unit: mm[inch]
Wire range: 24-12 AWG
Tightening torque: Max 0.4 N·m
General tolerances: ±0.50[±0.020]

URB1D_LD-20WR3A4S (without heatsink) Dimensions

THIRD ANGLE PROJECTION 

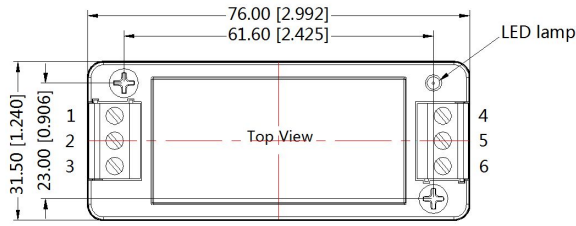

		Pin-Out					
Pin	1	2	3	4	5	6	
Dual	Ctrl	GND	Vin	-Vo	0V	+Vo	

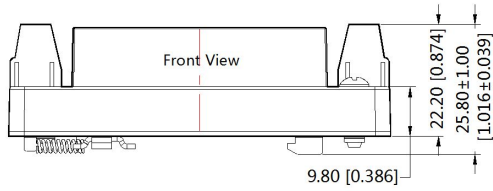

Note:
Unit: mm[inch]
Wire range: 24-12 AWG
Tightening torque: Max 0.4 N·m
General tolerances: ±0.50[±0.020]

URB1D_LD-20WHR3A4S (with heatsink) Dimensions

THIRD ANGLE PROJECTION 

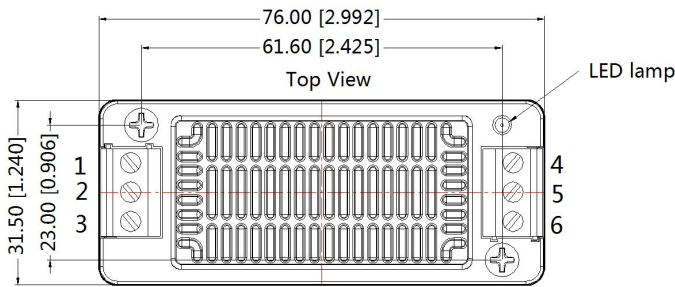

		Pin-Out					
Pin	1	2	3	4	5	6	
Dual	Ctrl	GND	Vin	-Vo	0V	+Vo	

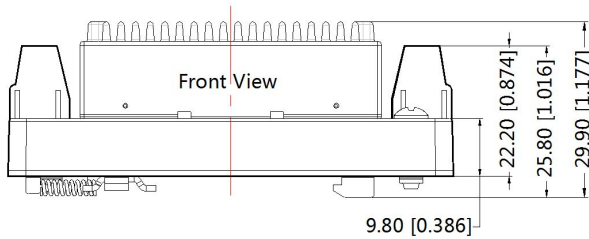

Note:
Unit: mm[inch]
Mounting rail: TS35
Wire range: 24-12 AWG
Tightening torque: Max 0.4 N·m
General tolerances: ±1.00[±0.039]

Note:

1. Packing information please refer to Product Packing Information which can be downloaded from www.mornsun-power.com. The Packing bag number of Horizontal package :58200035(without heat sink), 58200051(with heat sink), A2S/ A4S package number: 58220022;
2. The maximum capacitive load offered were tested at input voltage range and full load;
3. Unless otherwise specified, parameters in this datasheet were measured under the conditions of $T_a=25^{\circ}\text{C}$, humidity<75% with nominal input voltage and rated output load;
4. All index testing methods in this datasheet are based on our Company's corporate standards;
5. We can provide product customization service, please contact our technicians directly for specific information;
6. Products are related to laws and regulations: see "Features" and "EMC";
7. Our products shall be classified according to ISO14001 and related environmental laws and regulations, and shall be handled by qualified units.

Mornsun Guangzhou Science & Technology Co., Ltd.

Address: No. 5, Kehui St. 1, Kehui Development Center, Science Ave., Guangzhou Science City, Luogang District, Guangzhou, P. R. China
Tel: 86-20-38601850-8801 Fax: 86-20-38601272 E-mail: info@mornsun.cn