

DETAILS

Product Number	C13757_STRADA-SQ-FS-NP
Family	Strada
Type	Lens
Color	clear
Diameter	25x25 mm
Height	12,4 mm
Style	square
Optic Material	PMMA
Holder Material	
Fastening	glue
Status	production ready
ROHS Compliant	Yes
Date Updated	9/05/2014



OPTICAL PROPERTIES

LED	Viewing Angle	Light Beam	Efficiency	cd/lm	Connector
PSL445	Asymmetric deg	Asymmetric	94 %	0.750	-
MK-R	asymmetric deg	Asymmetric	93 %	0.900	-
XT-E	asymmetric deg	Asymmetric	93 %	1.200	-
XM-L	asymmetric deg	Asymmetric	93 %	1.200	-
XP-L	Asymmetric deg	Asymmetric	94 %	1.100	-
XHP50	Asymmetric deg	Asymmetric	94 %	0.890	-
XHP70	asymmetric deg	Asymmetric	80 %	0.610	Undefined Manufacturer: Protective Plate, Glass
XP-L2	Asymmetric deg	Asymmetric	94 %	0.800	-
LUXEON M/MX	asymmetric deg	Asymmetric	92 %	0.900	-
Duris P10	sim: Asymmetric	Asymmetric	sim: 91 %	sim: 1.050	-

D

C

B

A

4

4

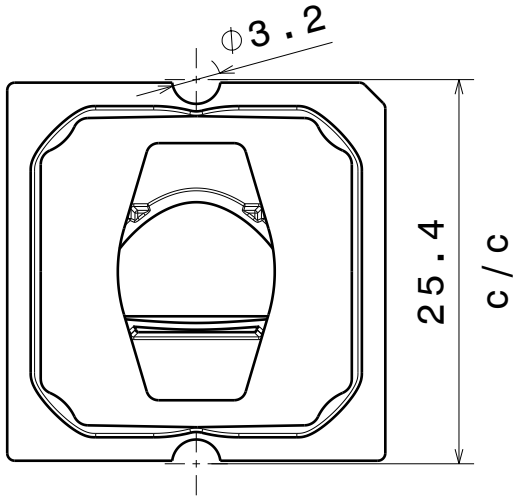

Bottom view

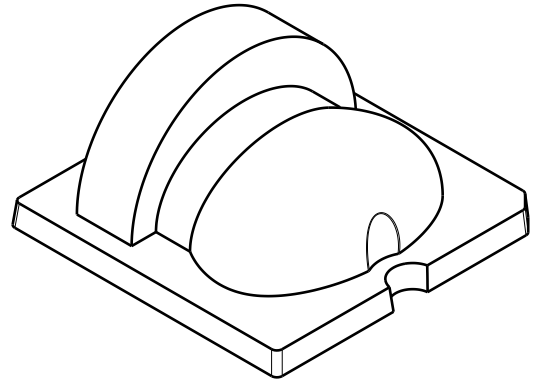

Isometric view

3

3

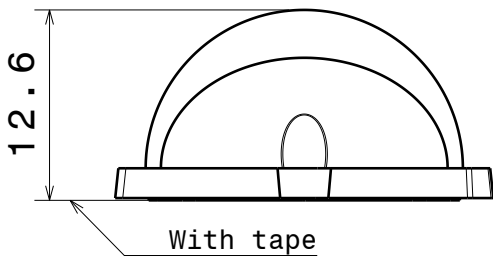

Front view

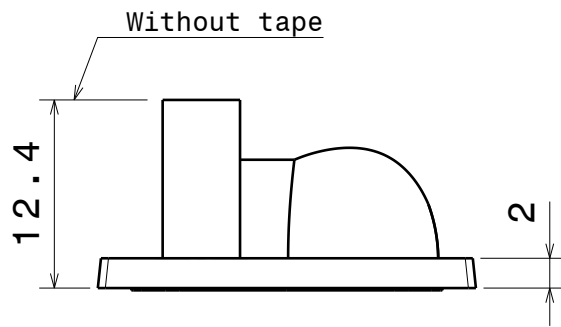

Left view

2

2

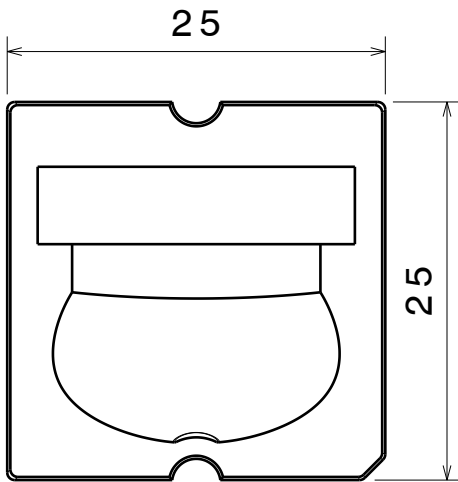

Top view

Tolerances if not otherwise shown
 According to DIN ISO 2768-1
 Linear measures:
 Up to 30mm class M, otherwise class C.
 According to DIN ISO 2768-2
 Form and position: class L

LEDiL Ledil Oy
 Salorankatu 10
 FIN 24240 SALO
 Finland

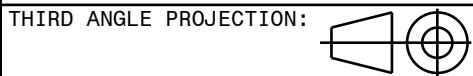

DRAWING TITLE

STRADA-SQ-FS-NP

This drawing is the property
 of LEDiL Oy. It may not be
 reproduced, copied or
 communicated without a written
 agreement with LEDiL Oy."

SIZE	PART NUMBER
A4	-

SCALE	2:1	WEIGHT	- g	SHEET	1/1
-------	-----	--------	-----	-------	-----

D

A

1

1

Luminaire: LEDiL Oy C13757_STRADA-SQ-FS-NP_(PSL445)
Lamps: 1 x Citizen_PSL445_424.116lm@250mA_P=2.81625W_I=0.250A_CCT=2700K

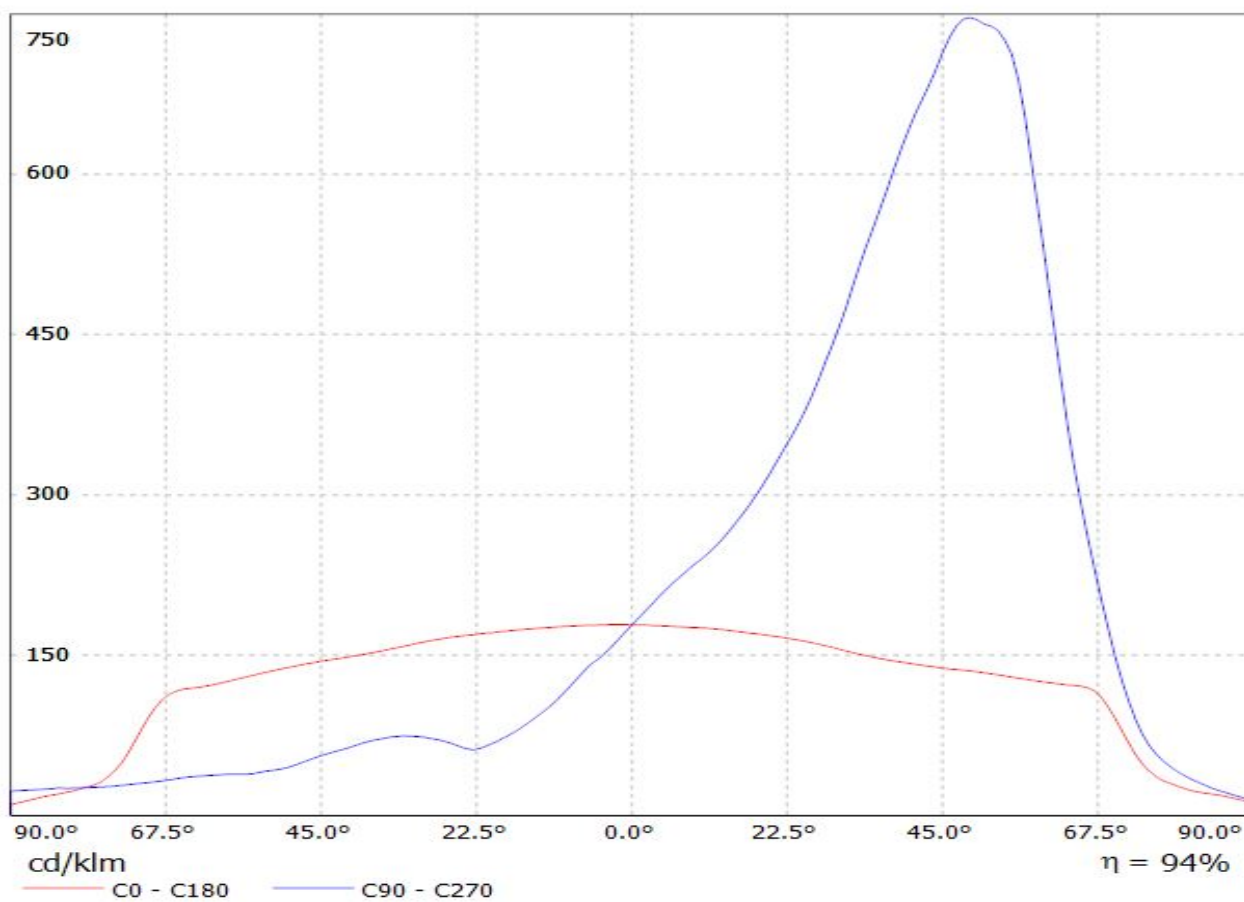

Luminaire: LEDiL Oy C13757_STRADA-SQ-FS-NP_(MK-R) Eff.92.6%
Lamps: 1 x CREE_MK-R_358.348lm@250mA_P=2.84311W_I=249.9mA

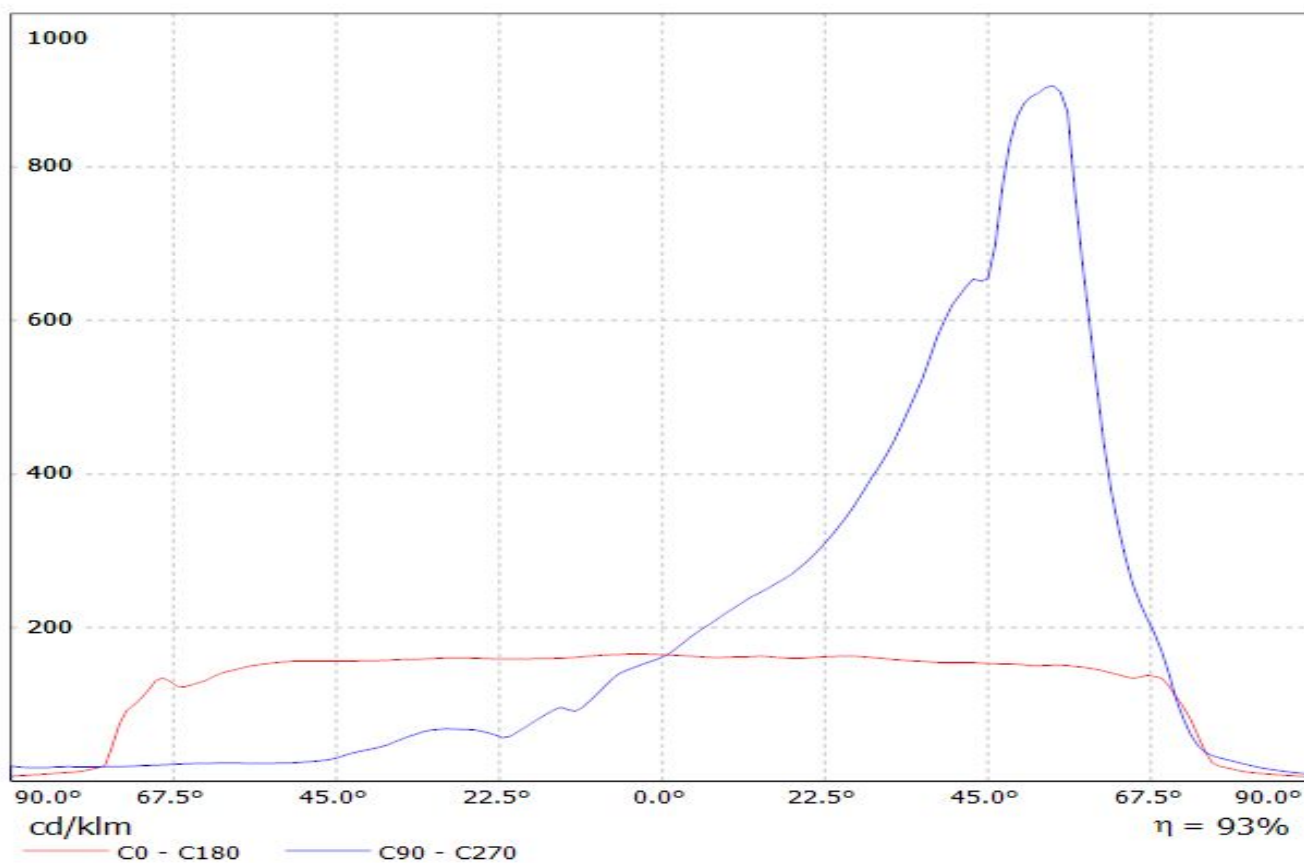

Luminaire: LEDiL Oy C13757_STRADA-SQ-FS-NP_(XM-L) Eff.93.1%
Lamps: 1 x CREE_XM-L_(XMLAWT-00-0000-0000T6051)_100.386lm@259mA_P=0.724735W_I=249.9mA

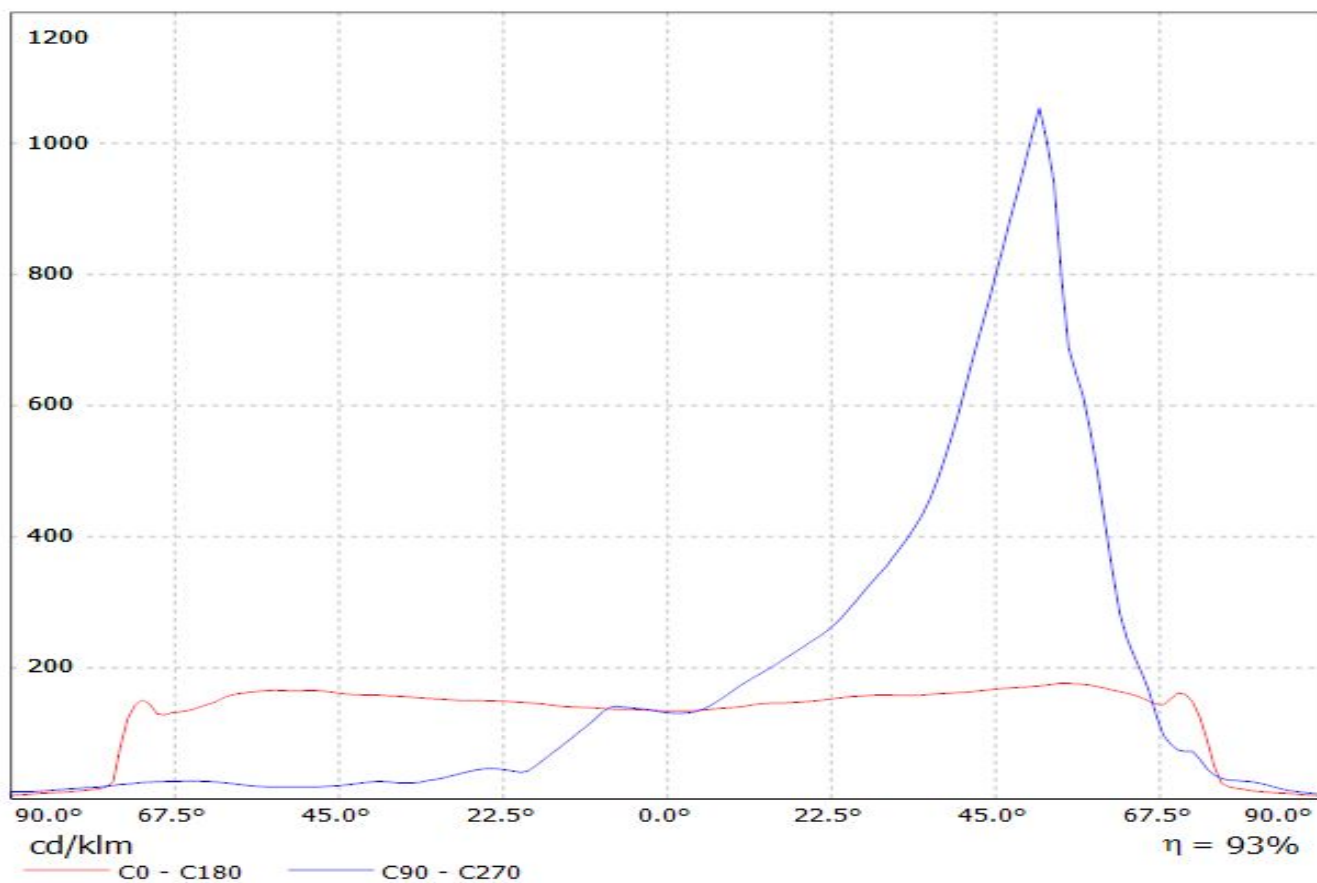

Luminaire: LEDiL Oy C13757_STRADA-SQ-FS-NP_(XP-L)
Lamps: 1 x Cree_XP-L_125.584lm@250mA_P=0.738255W_I=249.9mA

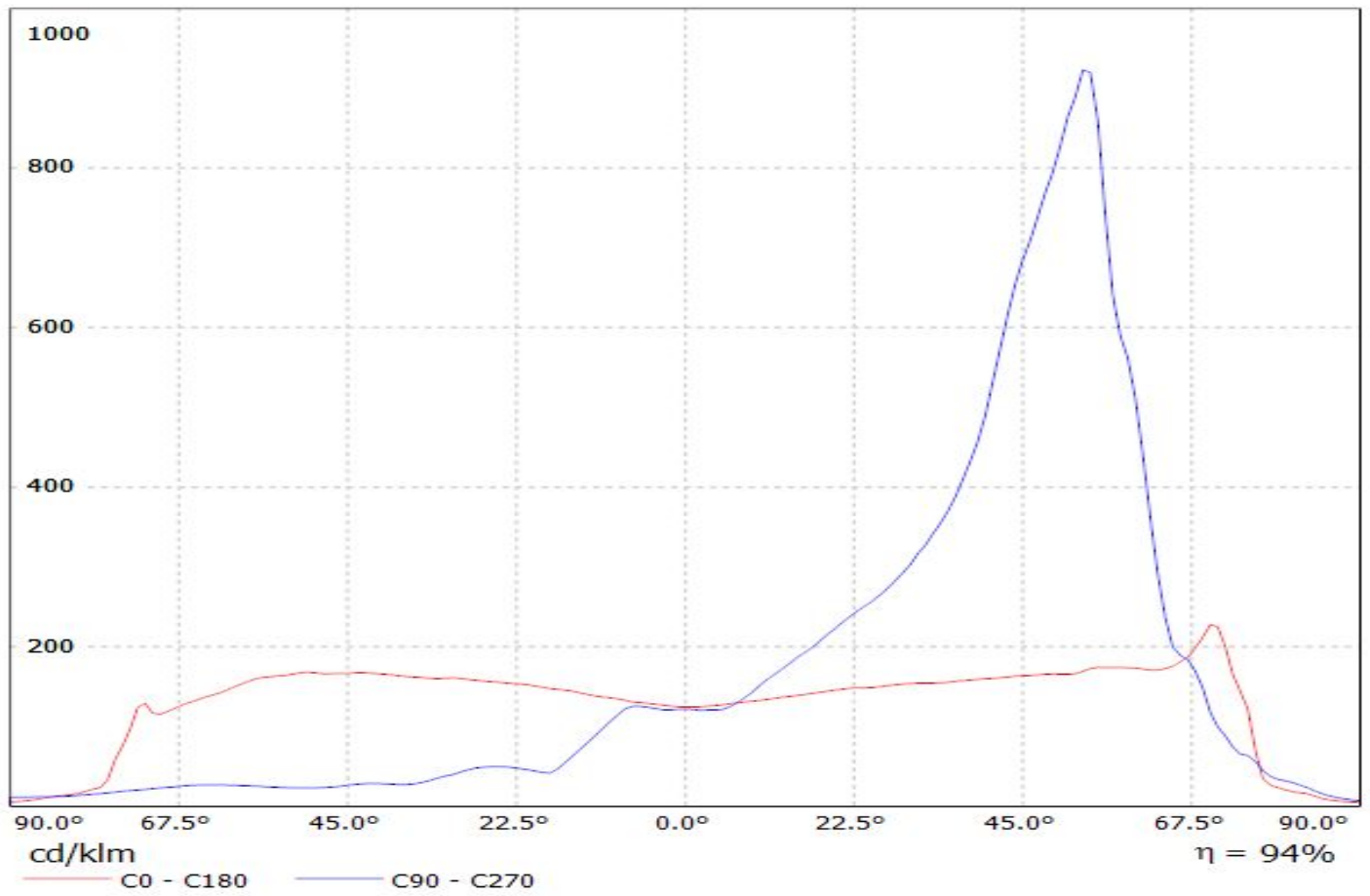

Luminaire: LEDiL Oy C13757_STRADA-SQ-FS-NP_(Cree_XHP50_cool_white)
Lamps: 1 x Cree_XHP50_cool_white_243.798lm@250mA_P=1.42945W_I=0.2499A

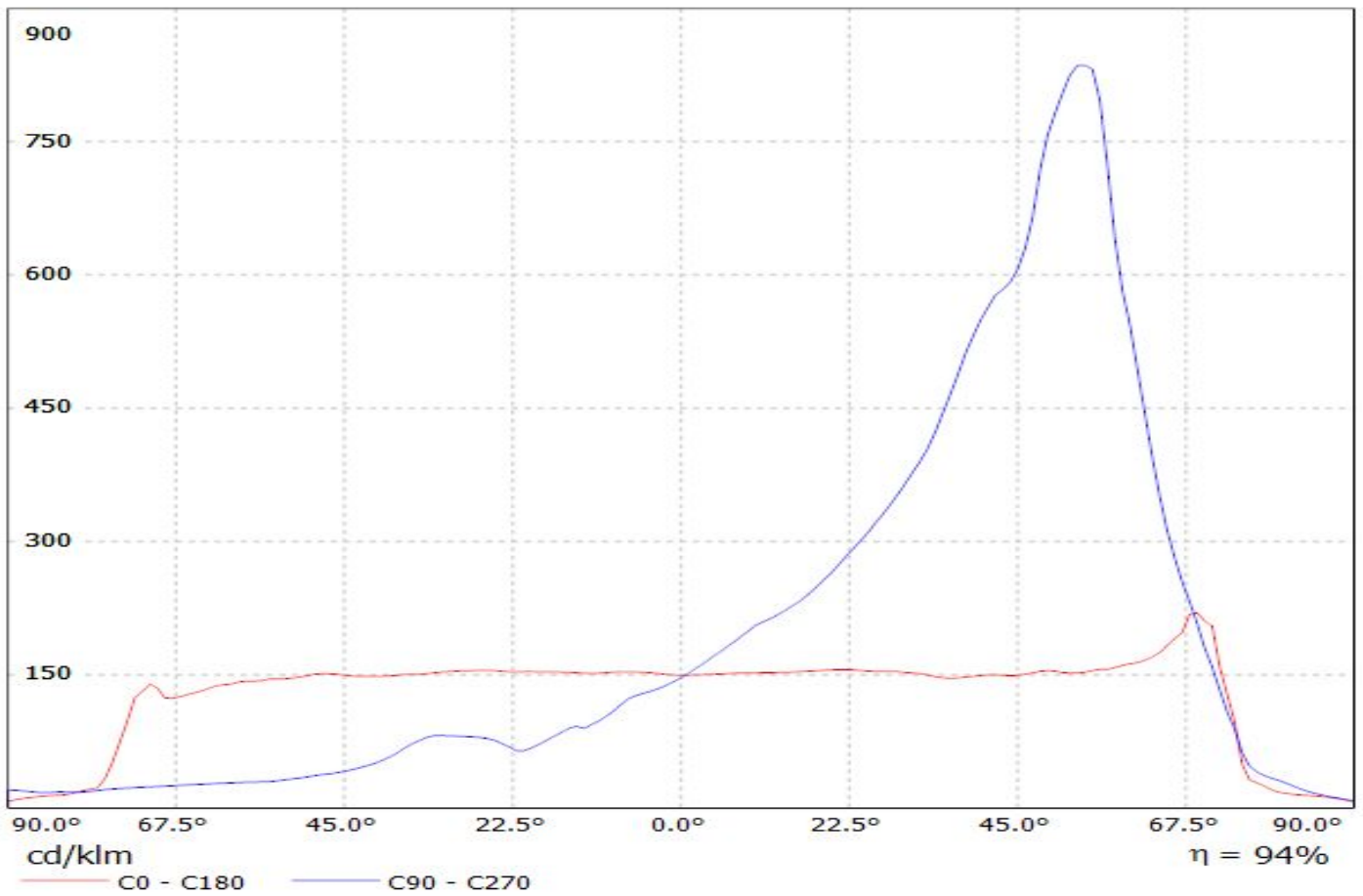

Luminaire: LEDiL Oy C13757_STRADA-SQ-FS-NP_(XHP70)_glass
Lamps: 1 x Cree_XHP70_glass-chassis_260.488lm@250mA_P=1.38405W_I=0.2499A

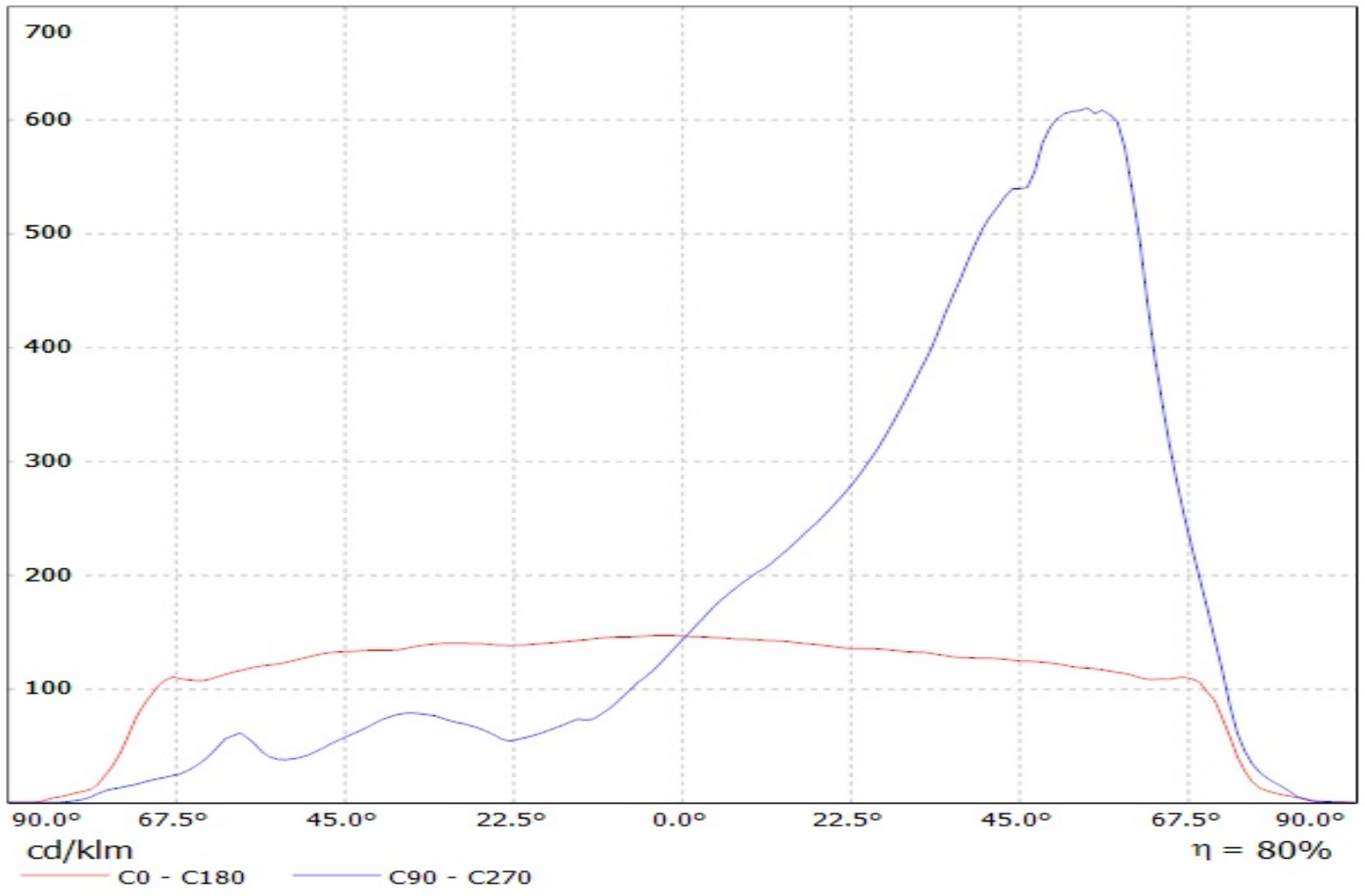

Luminaire: Ledil C13757_STRADA-SQ-FS-NP_(XP-L2)

Lamps: 1 x Cree_XP-L2_(XPLWT-00-0000-000HU630G)_115.868lm@250mA_P=0.717875W_I=0.25A

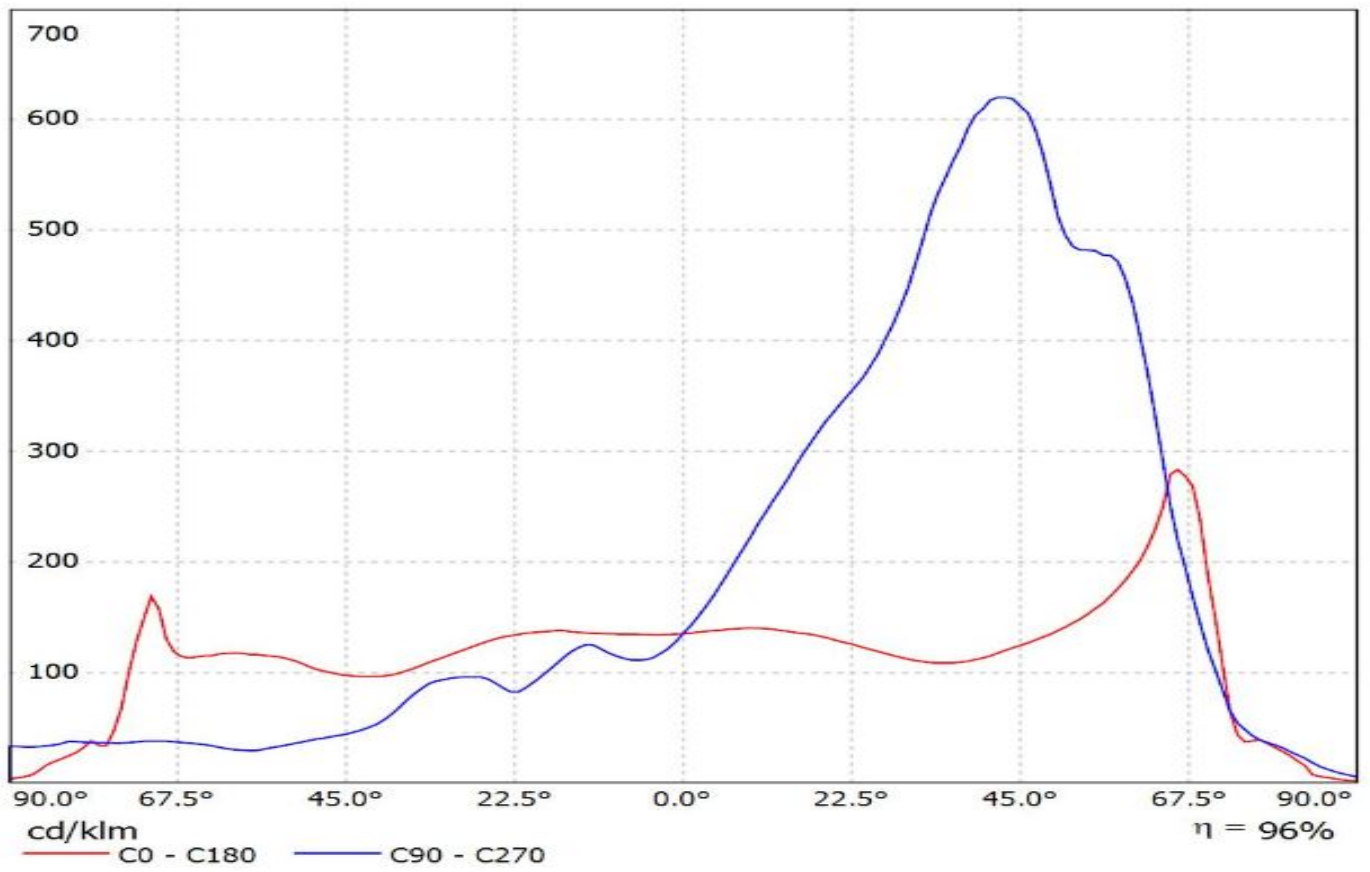

Luminaire: LEDiL Oy C13757_STRADA-SQ-FS-NP_(LUXEON_M) Eff.92.4%
Lamps: 1 x LUXEON_M_349.54lm@250mA_CCT=4092K_P=2.72807W_I=249.8mA

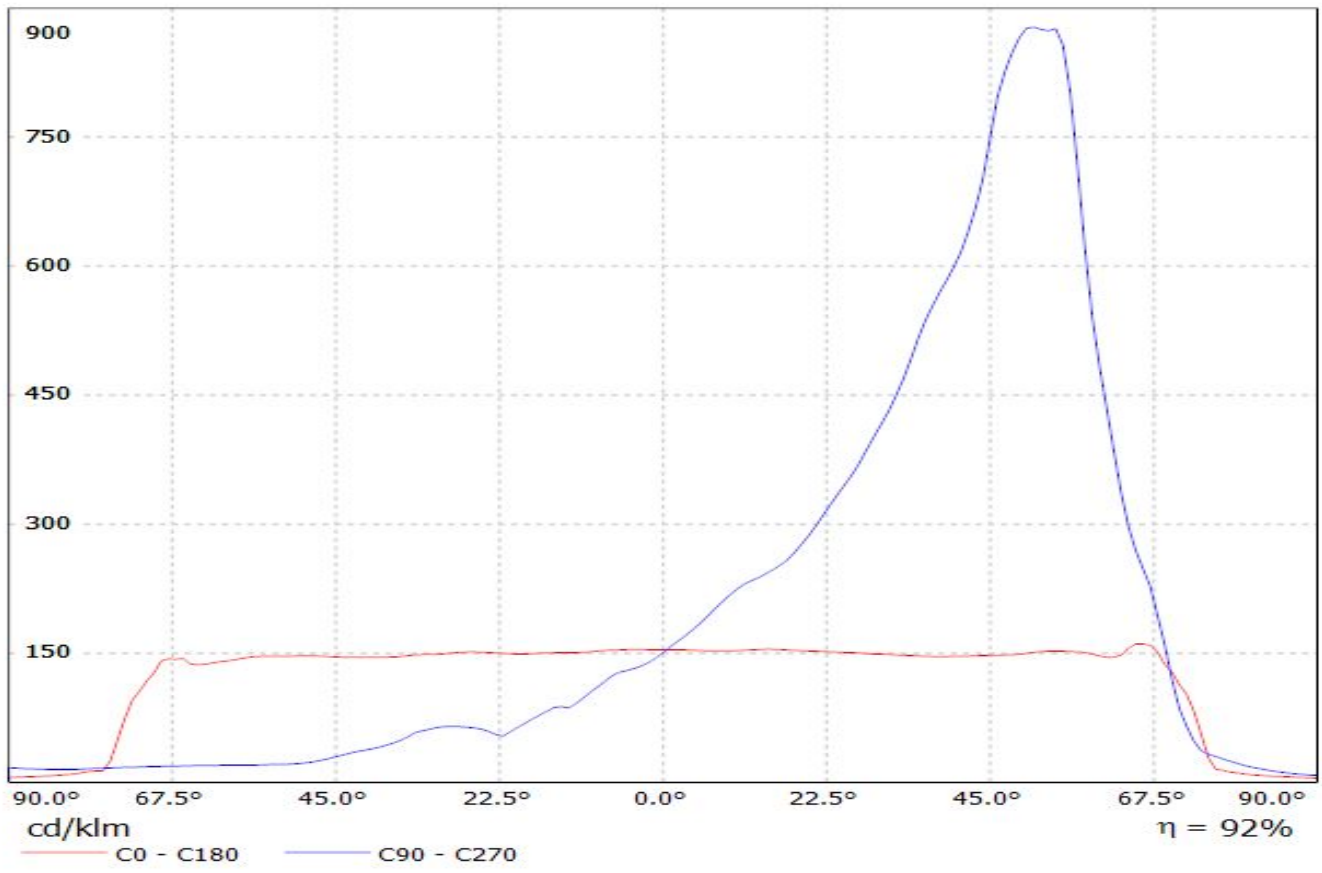

Luminaire: LEDiL Oy C13757_STRADA-SQ-FS-NP_(PSL445)

Lamps: 1 x Citizen_PSL445_424.116lm@250mA_P=2.81625W_I=0.250A_CCT=2700K

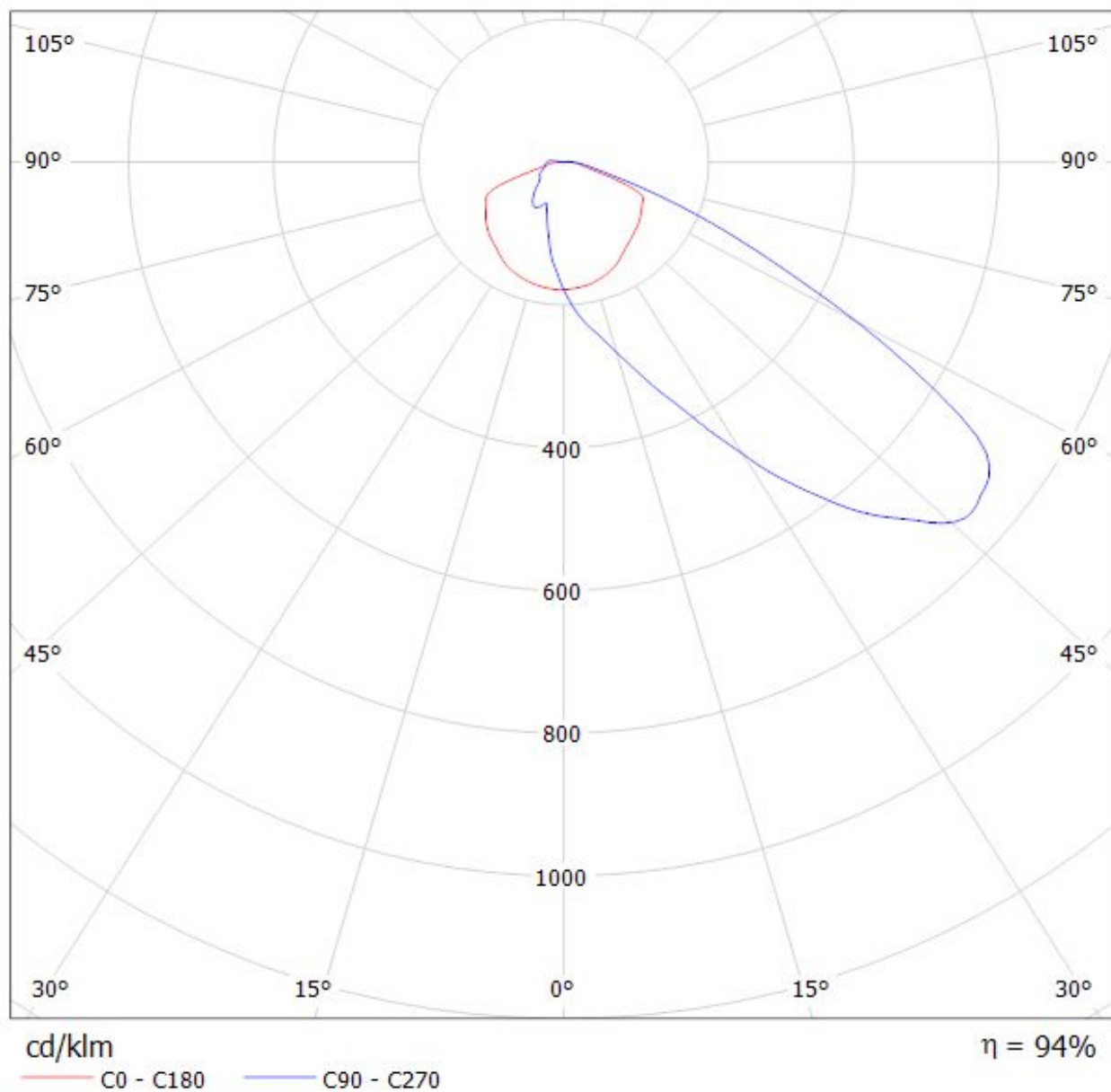

Luminaire: LEDiL Oy C13757_STRADA-SQ-FS-NP_(MK-R) Eff.92.6%
Lamps: 1 x CREE_MK-R_358.348lm@250mA_P=2.84311W_I=249.9mA

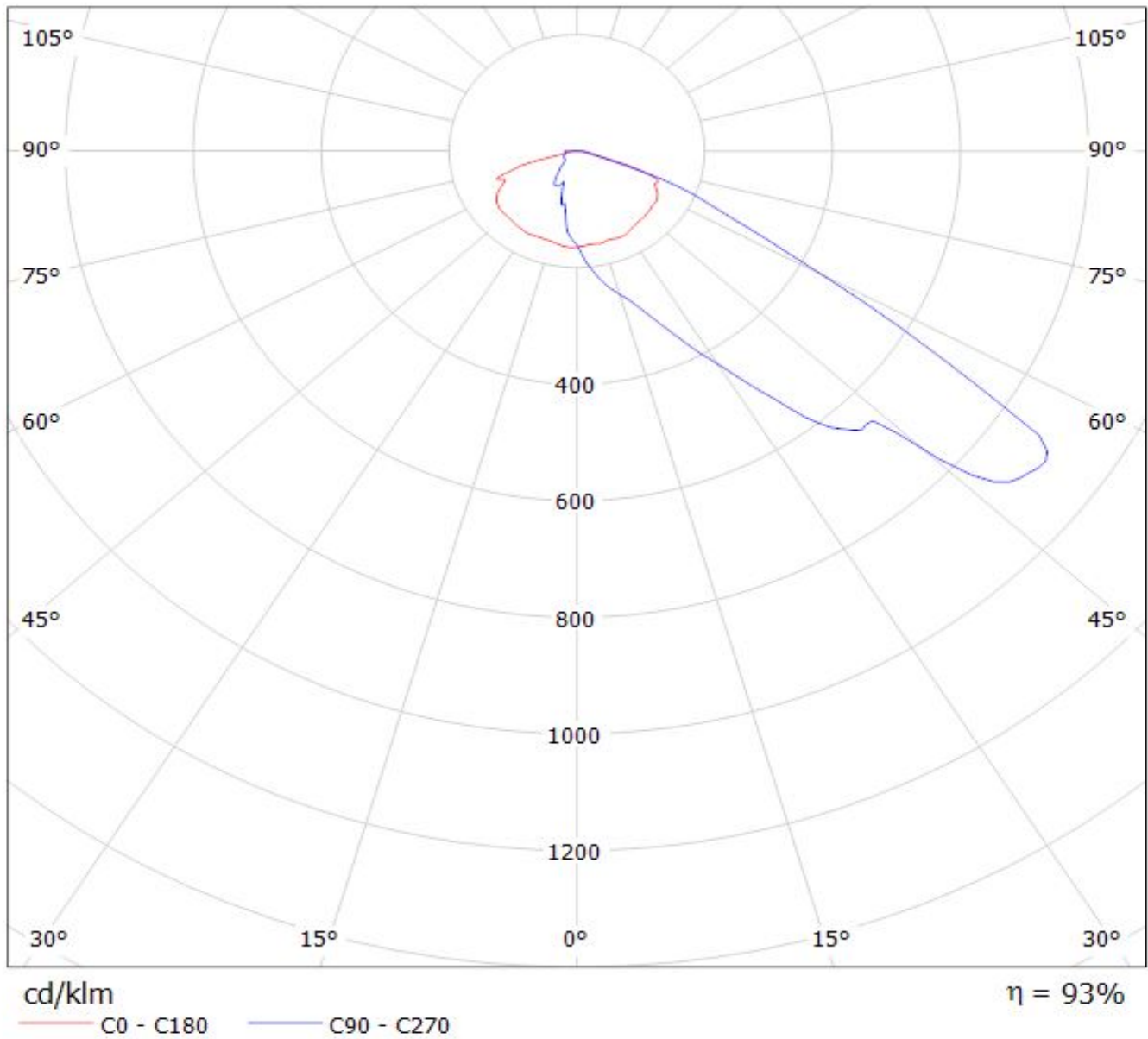

Luminaire: LEDiL Oy C13757_STRADA-SQ-FS-NP_(XT-E) Eff.93.0%
Lamps: 1 x CREE_XT-E_(XTEAWT-00-0000-00000HBE8)_73.2149lm@250mA_P=0.779476W_I=249.9mA

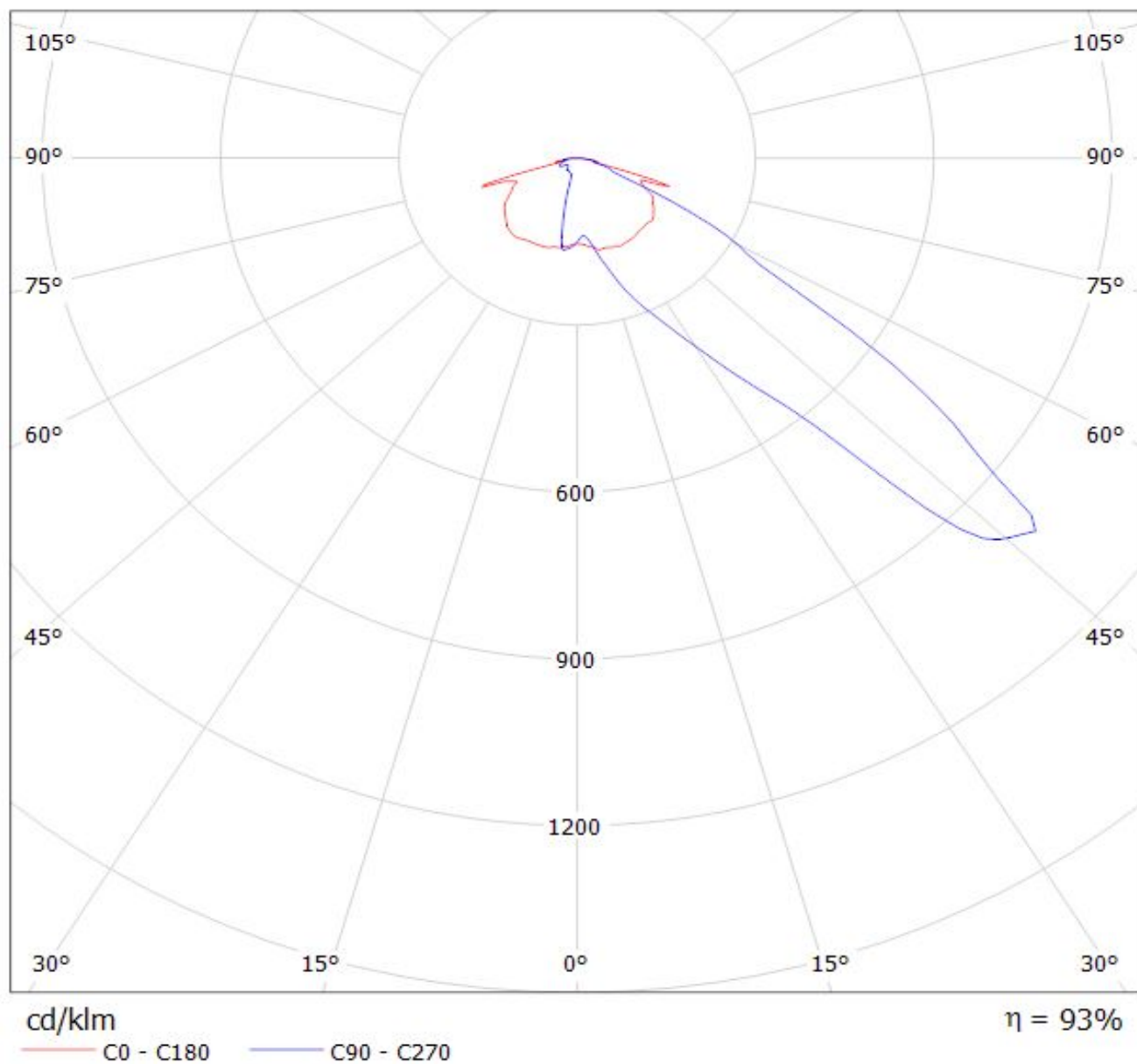

Luminaire: LEDiL Oy C13757_STRADA-SQ-FS-NP_(XM-L) Eff.93.1%

Lamps: 1 x CREE_XM-L_(XMLAWT-00-0000-0000T6051)_100.386lm@259mA_P=0.724735W_I=249.9mA

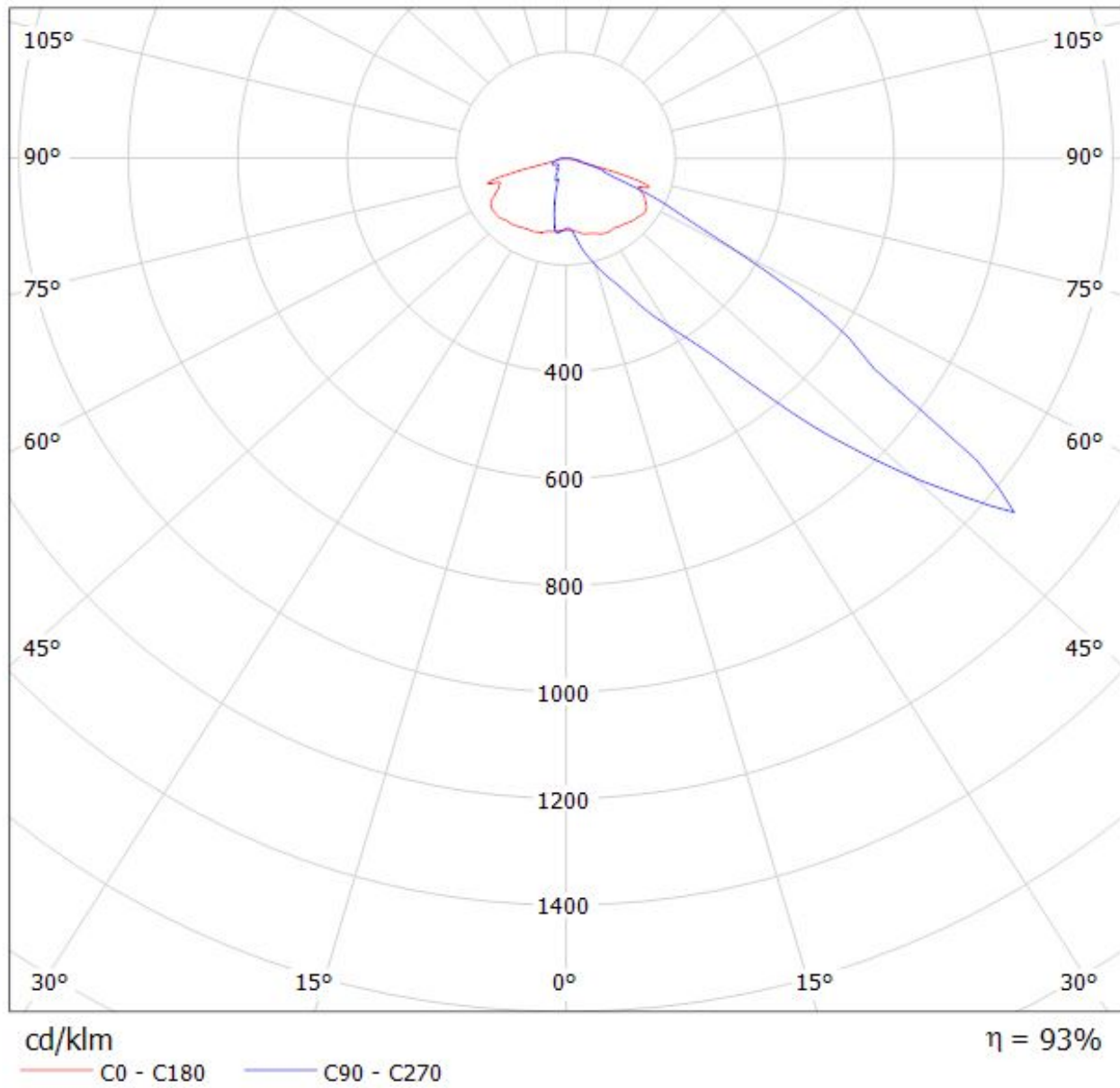

Luminaire: LEDiL Oy C13757_STRADA-SQ-FS-NP_(XP-L)

Lamps: 1 x Cree_XP-L_125.584lm@250mA_P=0.738255W_I=249.9mA

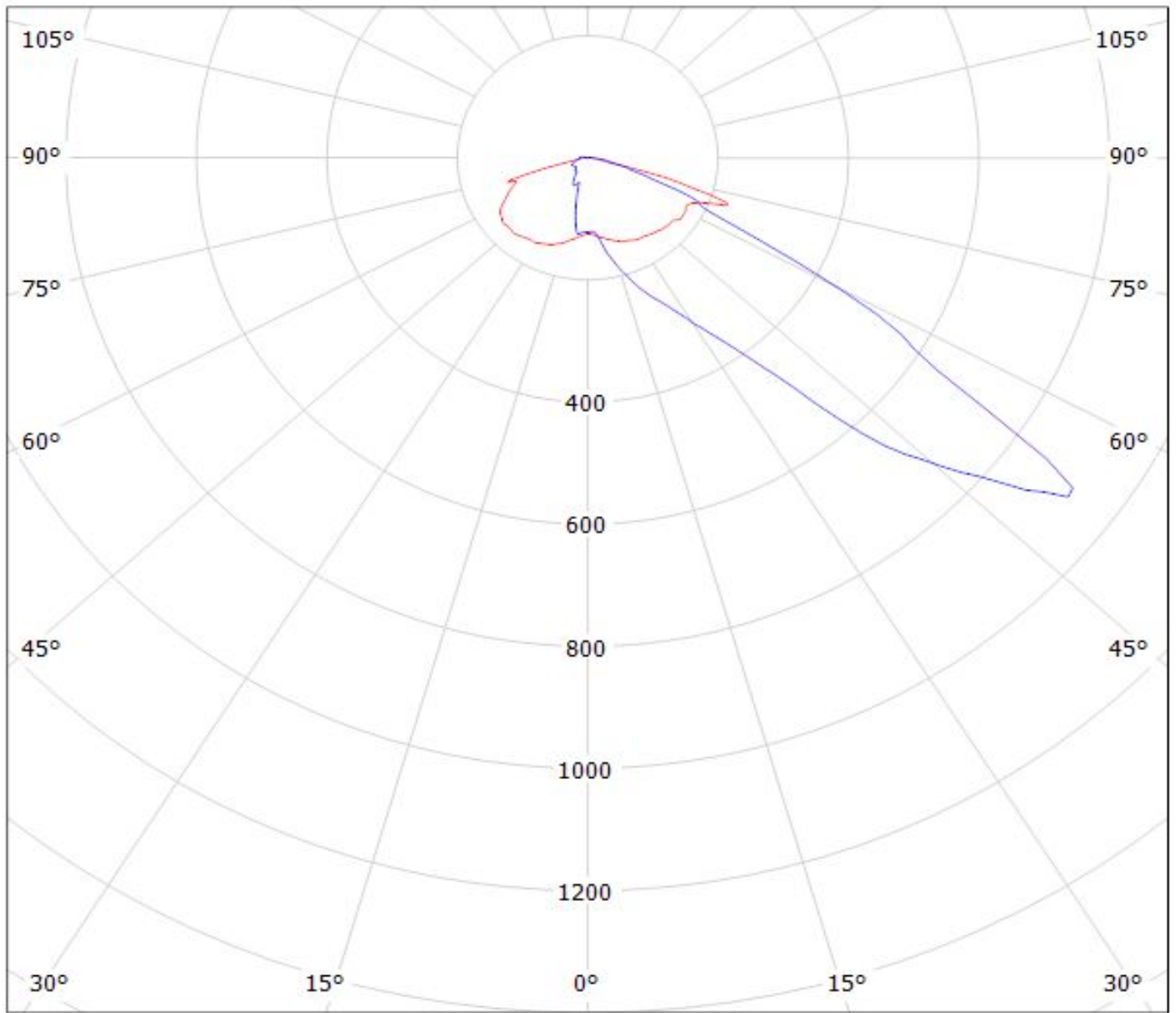

cd/klm

— C0 - C180

— C90 - C270

$\eta = 94\%$

Luminaire: LEDiL Oy C13757_STRADA-SQ-FS-NP_(Cree_XHP50_cool_white)
Lamps: 1 x Cree_XHP50_cool_white_243.798lm@250mA_P=1.42945W_I=0.2499A

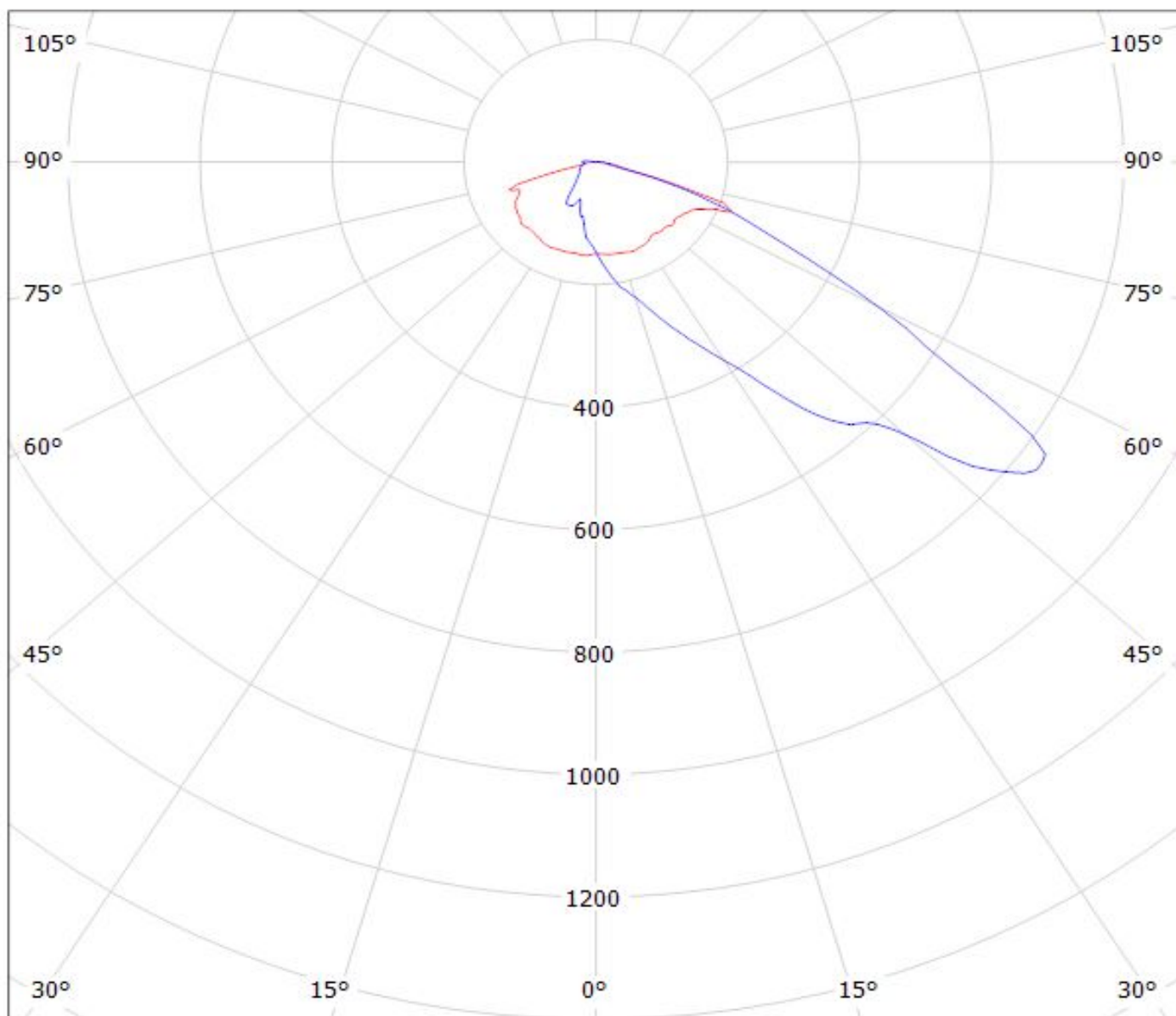

cd/klm

— C0 - C180 — C90 - C270

$\eta = 94\%$

Luminaire: LEDiL Oy C13757_STRADA-SQ-FS-NP_(XHP70)_glass

Lamps: 1 x Cree_XHP70_glass-chassis_260.488lm@250mA_P=1.38405W_I=0.2499A

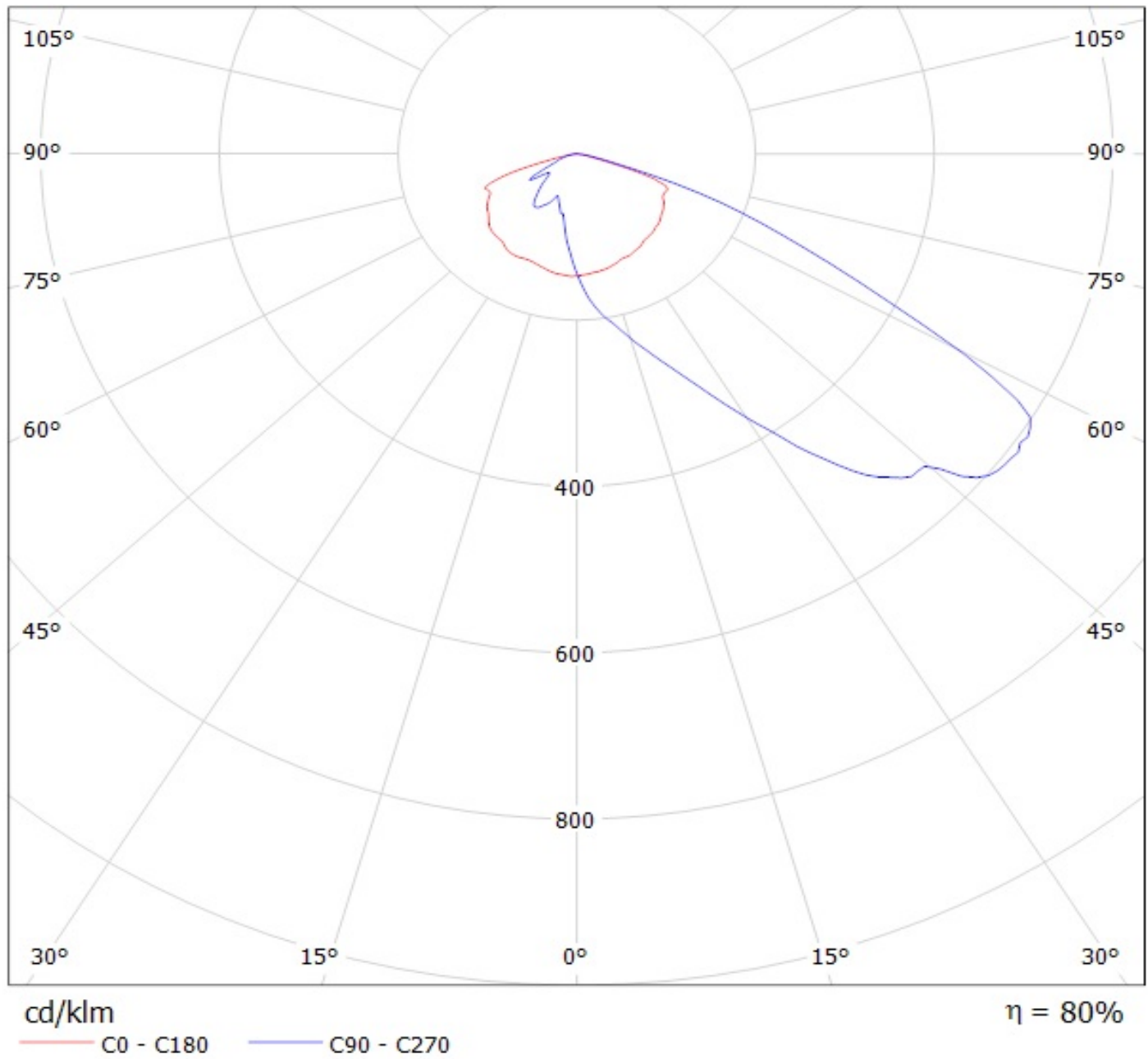

Luminaire: Ledil C13757_STRADA-SQ-FS-NP_(XP-L2)

Lamps: 1 x Cree_XP-L2_(XPLWT-00-0000-000HU630G)_115.868lm@250mA_P=0.717875W_I=0.25A

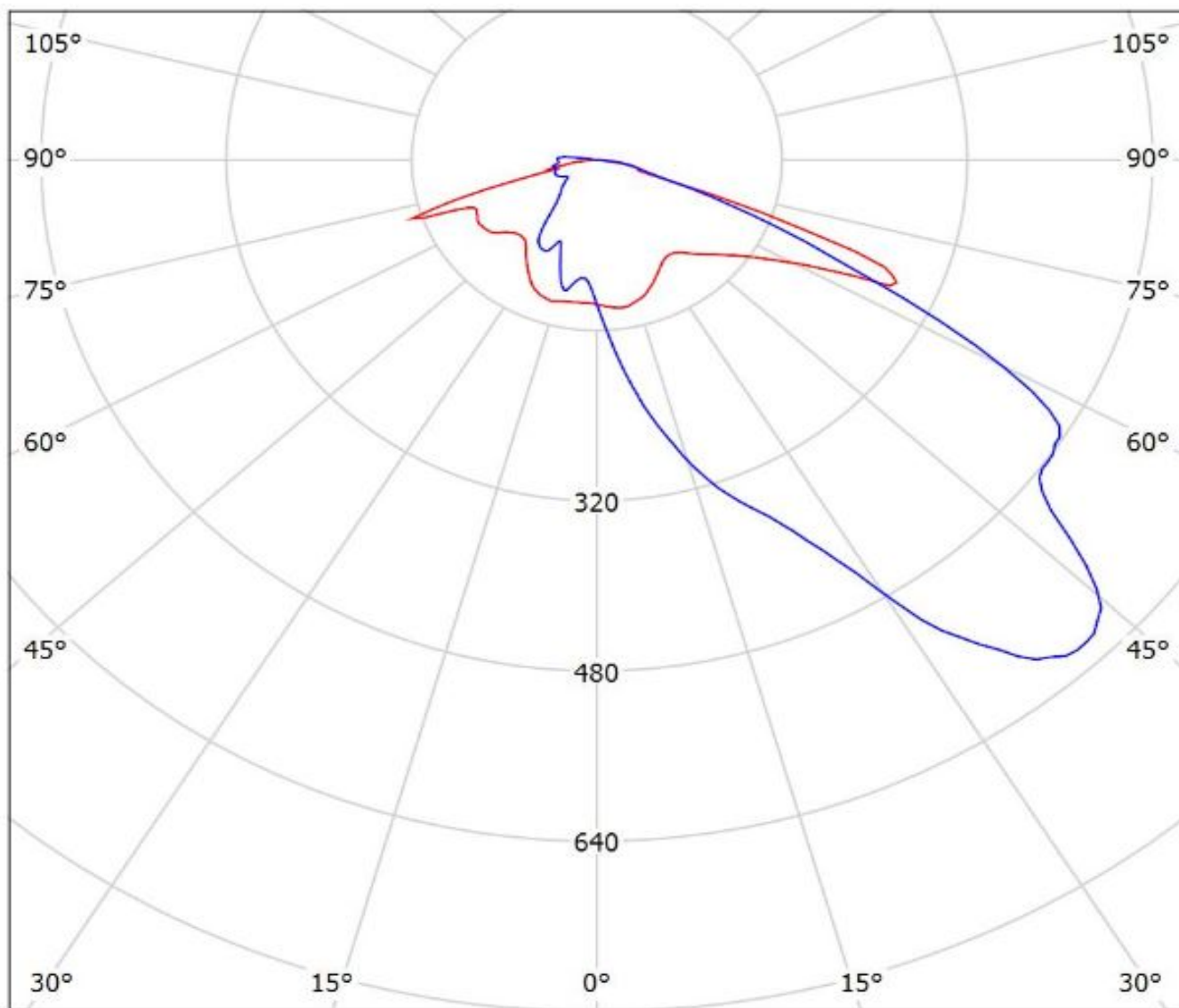

cd/klm

— C0 - C180

— C90 - C270

$\eta = 96\%$

Luminaire: LEDiL Oy C13757_STRADA-SQ-FS-NP_(LUXEON_M) Eff.92.4%
Lamps: 1 x LUXEON_M_349.54lm@250mA_CCT=4092K_P=2.72807W_I=249.8mA

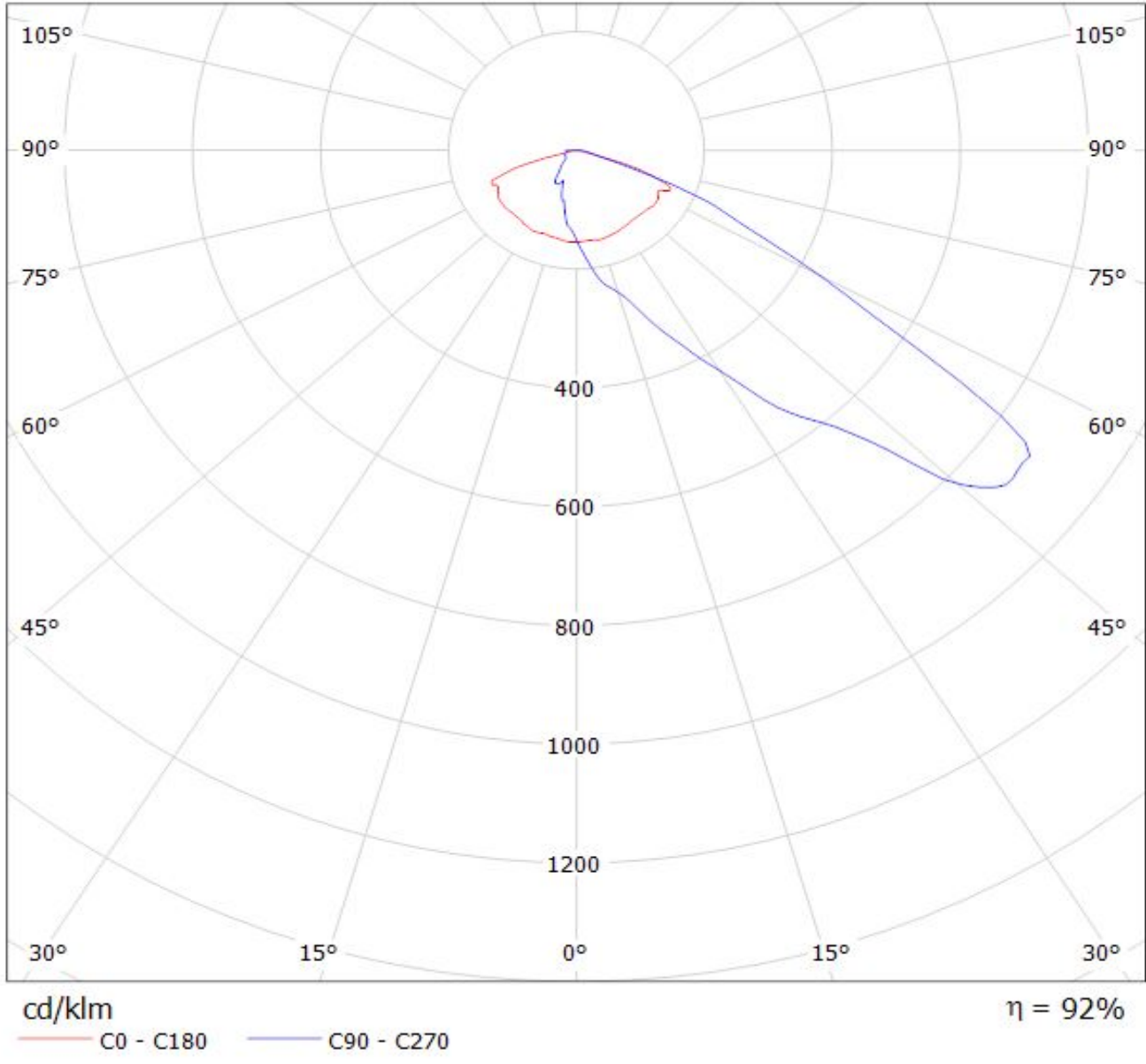

NOTE: The typical divergence will be changed by different color, chip size and chip position tolerance. The typical total divergence is the full angle measured where the luminous intensity is half of the peak value.