

Product Overview

The QPA9903 is a high-efficiency, linearizable power amplifier targeting Band 3 small-cell wireless infrastructure systems. Using InGaP/GaAs HBT technology, the product delivers high efficiency of 33.8% at +28dBm average output power while providing excellent DPD linearized ACPR of -50dBc for signal bandwidths of up to 60MHz.

The QPA9903 is housed in a 5x5mm SMT package. It is pin-to-pin compatible to QPA9908 (band 8 high-efficiency small cell PA).



16 Pad 5 x 5 mm Package

Key Features

- 1805 – 1880 MHz
- 32 dB Gain typical across the band
- Over 36 dBm P3dB
- 33.8% PAE at +28 dBm power output
- <-50 dBc ACPR DPD linearized at +28 dBm power output with 1-carrier signal
- 1.8V logic compatible PA ON/OFF control
- On chip ESD protection

Functional Block Diagram

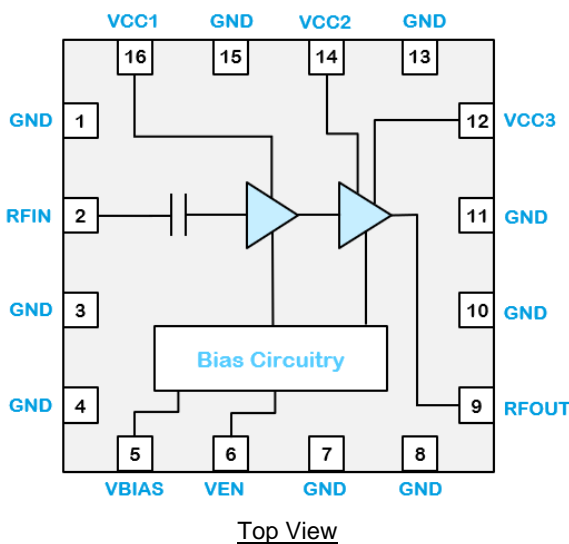

Applications

- 3GPP Band 3 Small Cells
- M-MIMO
- Repeaters / DAS
- Mobile Infrastructure
- General Purpose Wireless

Ordering Information

Part No.	Description
QPA9903TR13	2500 on reel
QPA9903EVB-01	1805-1880 MHz EVB

Absolute Maximum Ratings

Parameter	Rating
Storage Temperature	-55 to +125 °C
RF Input Power, Pulsed CW, 50 Ω ⁽¹⁾	+10 dBm
Device Voltage (V _{CC})	+5.5 V

Exceeding any one or a combination of the Absolute Maximum Rating conditions may cause permanent damage to the device. Extended application of Absolute Maximum Rating conditions to the device may reduce device reliability.

Note:

1. 1805-1880 MHz, Pulsed CW, 10% duty cycle, 100us period

Recommended Operating Conditions

Parameter	Min	Typ	Max	Units
Device Voltage (V _{CC})	+4.75	+5	+5.25	V
T _{CASE}	-40		+85	°C
T _j for >10 ⁶ hours MTTF			+175	°C

Electrical specifications are measured at specified test conditions. Specifications are not guaranteed over all recommended operating conditions.

Electrical Specifications

Parameter	Conditions ⁽¹⁾	Min	Typ	Max	Units
Operational Frequency Range		1805		1880	MHz
Test Frequency			1840		MHz
Gain	Pout = +28 dBm	30	32	34.2	dB
Input Return Loss			-17.5		dB
Output P3dB	10 μs pulse width, 10% duty cycle	33.5	36		dBm
Power Added Efficiency ⁽²⁾	Pout = +28 dBm	29	33.8		%
ACPR(Uncorrected) ⁽²⁾	Pout = +28 dBm		-34	-30	dBc
ACPR with DPD ⁽²⁾	Pout = +28 dBm		-50		dBc
ACPR(Uncorrected) ⁽³⁾	Pout = +28 dBm		-31		dBc
ACPR with DPD ⁽³⁾	Pout = +28 dBm		-45		dBc
Quiescent Current, I _{CC}	Pins 12, 14 and 16		92		mA
Total Operating Current	Pins 5, 12, 14 and 16, Pout = +28 dBm		360		mA
Thermal Resistance, θ _{JC}	Junction to case		27.4		°C/W
V _{EN} High		1.17	1.8	V _{CC}	V
V _{EN} Low		0	0	0.5	V
2nd Harmonic	Pout = +28 dBm		-30		dBc
3rd Harmonic	Pout = +28 dBm		-45		dBc

Notes:

1. Test conditions unless otherwise noted: All V_{CC} & V_{BIAS} = +5.0V, V_{EN} = +1.8V, Temp = +25 °C, 50 Ω system.
2. LTE, 20 MHz E-UTRA Test Model 1.1 or 3.1, PAR = 8.5 dB at 0.01% Probability
3. LTE, 20 MHz x 3 E-UTRA Test Model 1.1 or 3.1, PAR = 8.5 dB at 0.01% Probability

Power Amplifier Enable Logic Table

Parameter	High	Low
V _{EN}	Power Amplifier ON	Power Amplifier OFF

1805–1880 MHz Evaluation Board – QPA9903EVB01

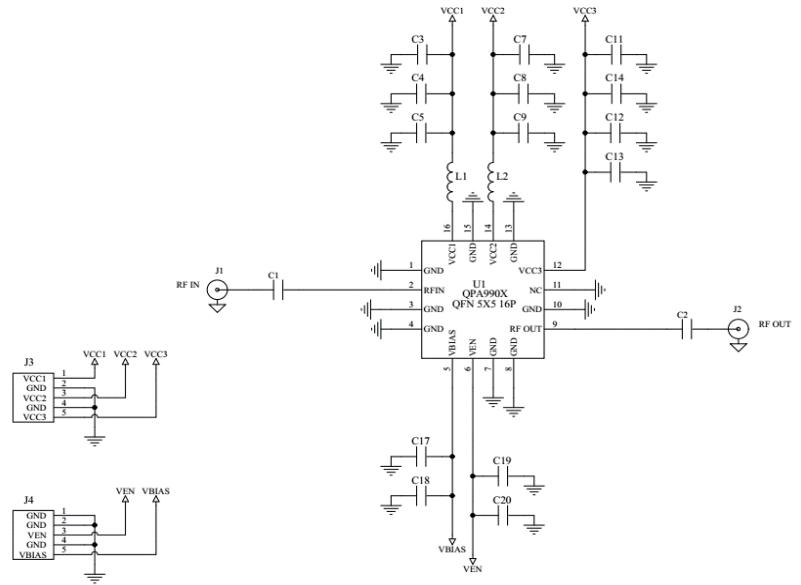
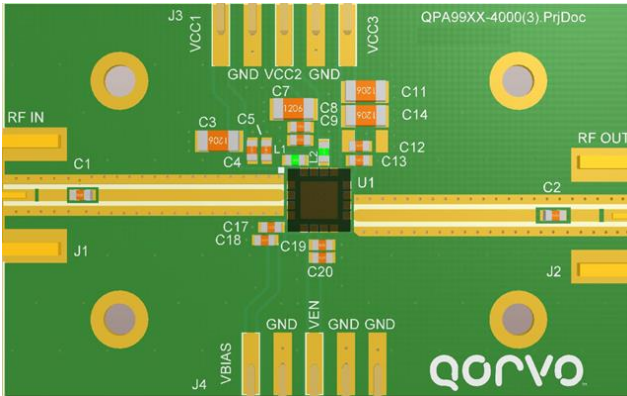

- Notes:
1. See Evaluation Board PCB Information for material and stack up.

Bill of Material – QPA9903EVB01

Reference Des.	Value	Description	Manuf.	Part Number
U1	-	Amplifier, QPA9903 1805-1880MHz, High-Efficiency	Qorvo	QPA9903
C1, C2	100 pF	CAP,100 pF, 0603, 5%, 50V, NPO	various	
C5, C9, C13, C17, C19	1000 pF	CAP,1000 pF, 0603, 5%, 50V, NPO	various	
C4, C8, C12, C18, C20	0.1 μF	CAP,0.1 μF, 0603, 10%, 50V, X7R	various	
C3, C7, C14	10 μF	CAP, 10 μF, 1206, 16V	various	
L1, L2	0 Ω	RES 0 Ω, 0603, 1/16W, Chip	various	

Performance Plots - LTE

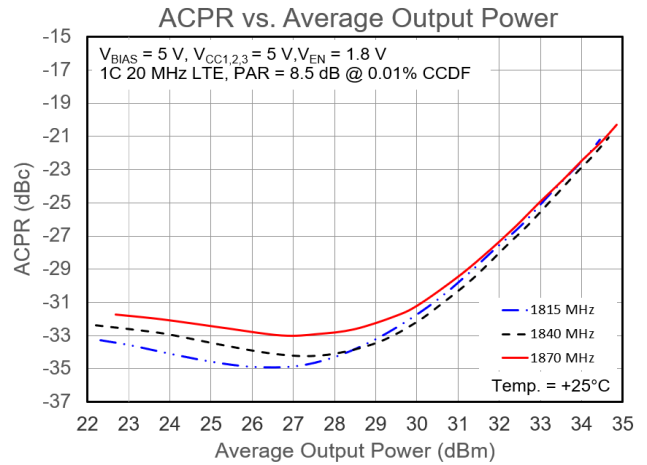
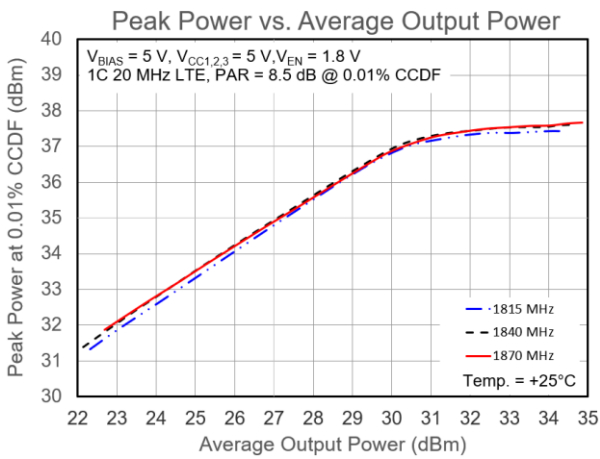
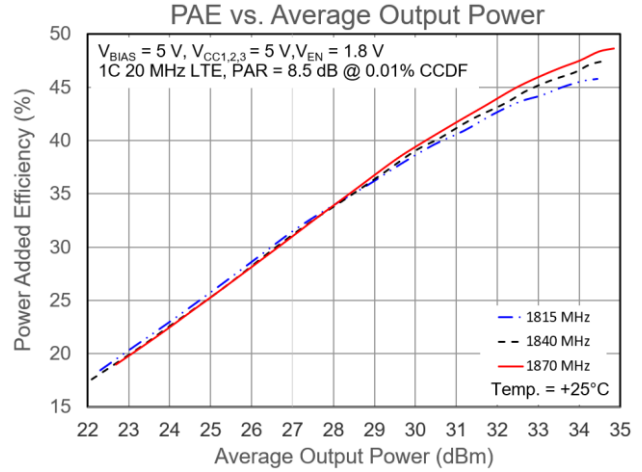
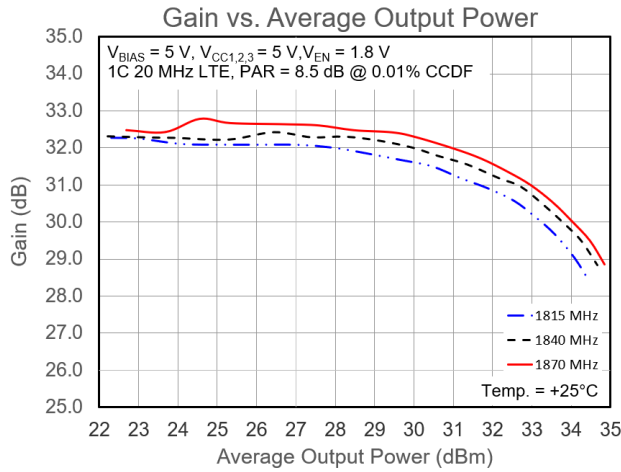

Test conditions unless otherwise noted: $V_{BIAS} = 5\text{ V}, V_{CC1,2,3} = 5\text{ V}, V_{EN} = 1.8\text{ V}, T = +25^\circ\text{C}$, tested using a single-carrier, 20 MHz LTE signal with 8.5 dB PAR at 0.01% CCDF on a reference design fixture.

Performance Plots - LTE

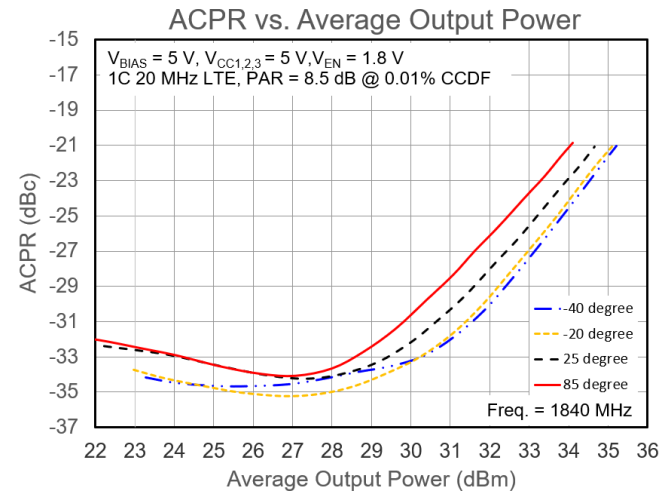
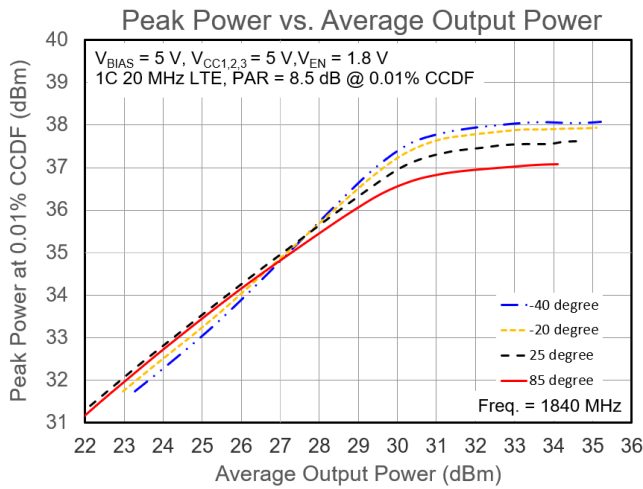
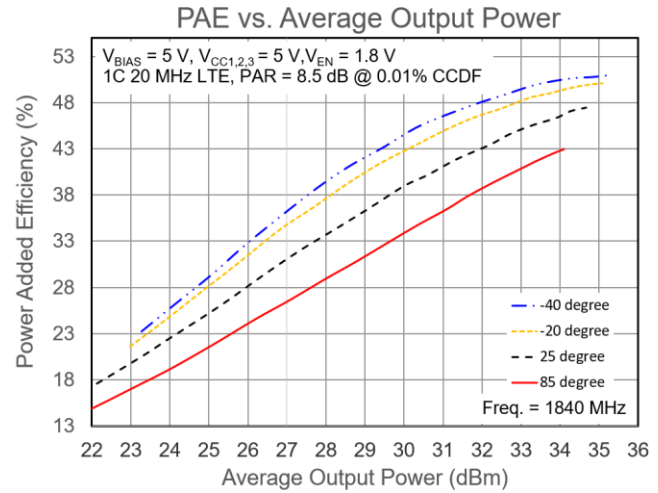
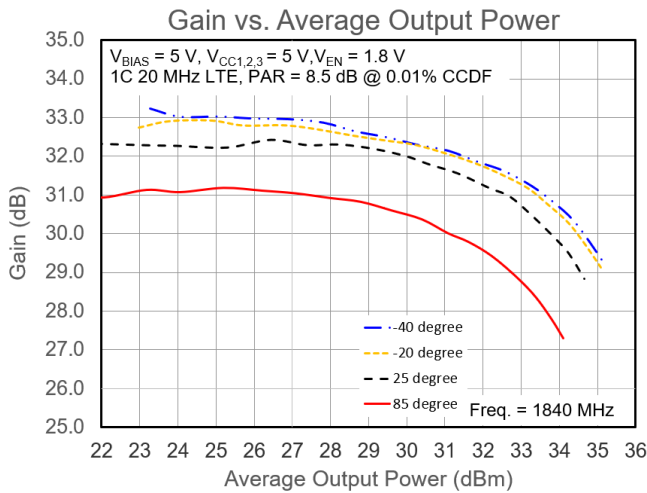

Test conditions unless otherwise noted: $V_{BIAS} = 5\text{ V}, V_{CC1,2,3} = 5\text{ V}, V_{EN} = 1.8\text{ V}$, tested at 1840 MHz using a single-carrier, 20 MHz LTE signal with 8.5 dB PAR at 0.01% CCDF on a reference design fixture.

Performance Plots - Pulse

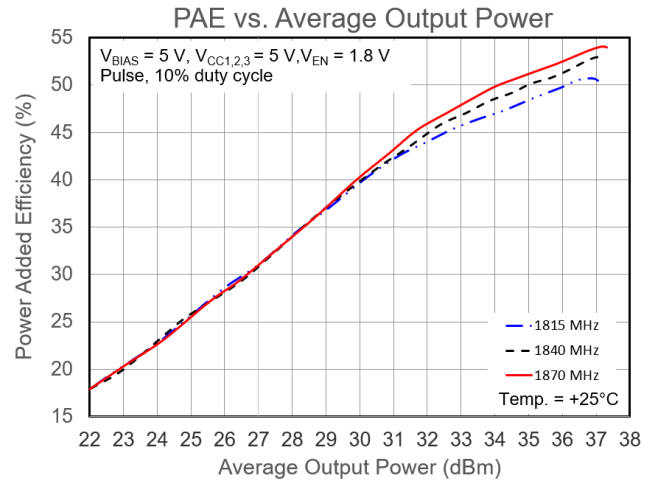
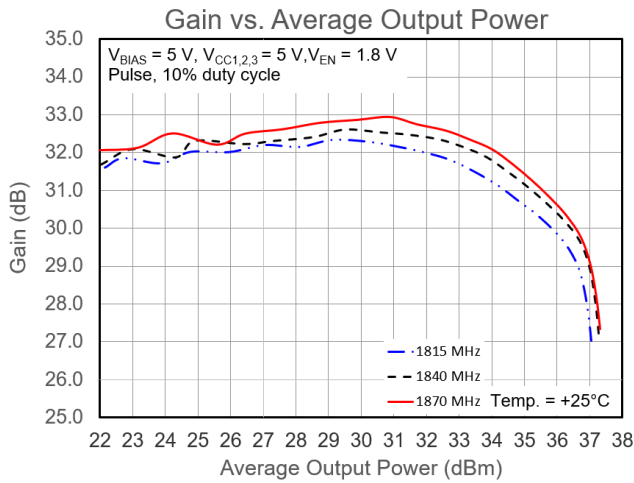

Test conditions unless otherwise noted: $V_{BIAS} = 5\text{ V}, V_{CC1,2,3} = 5\text{ V}, V_{EN} = 1.8\text{ V}, T = +25^\circ\text{C}$, tested using a pulse signal, 10% duty cycle.

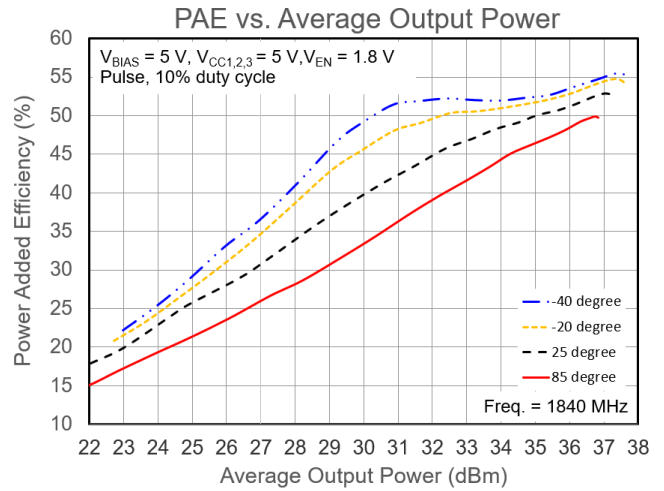
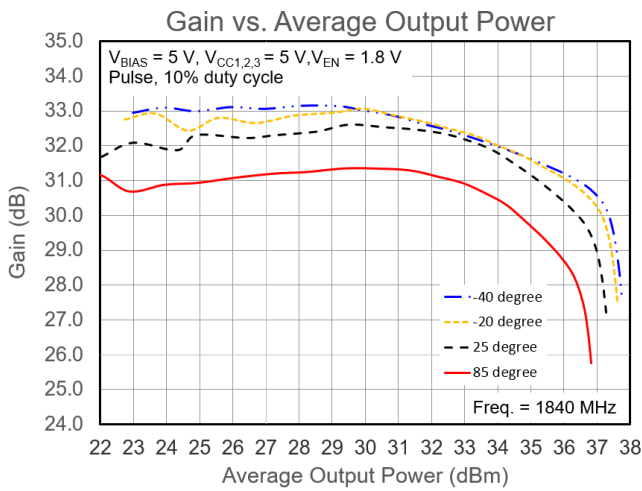

Test conditions unless otherwise noted: $V_{BIAS} = 5\text{ V}, V_{CC1,2,3} = 5\text{ V}, V_{EN} = 1.8\text{ V}$, tested at 1840 MHz using a pulse signal, 10% duty cycle.

Performance Plots – S-parameter

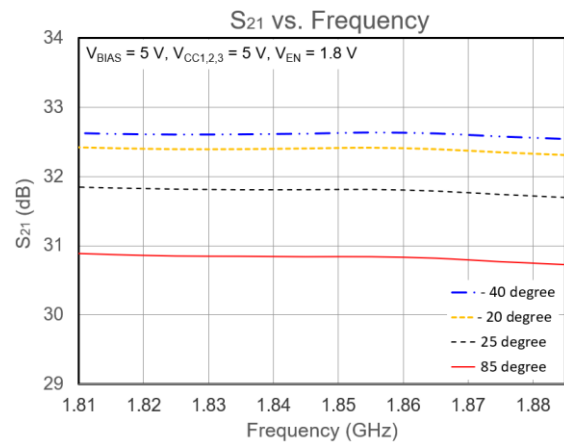
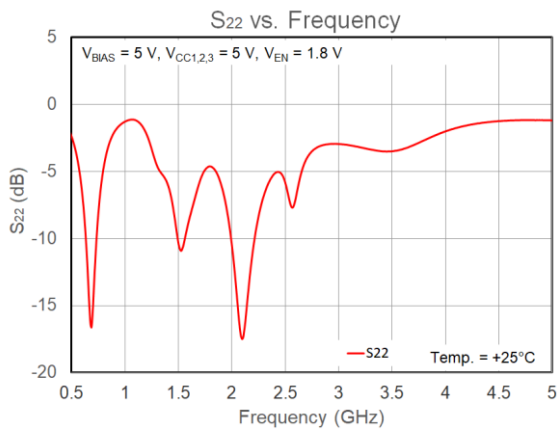
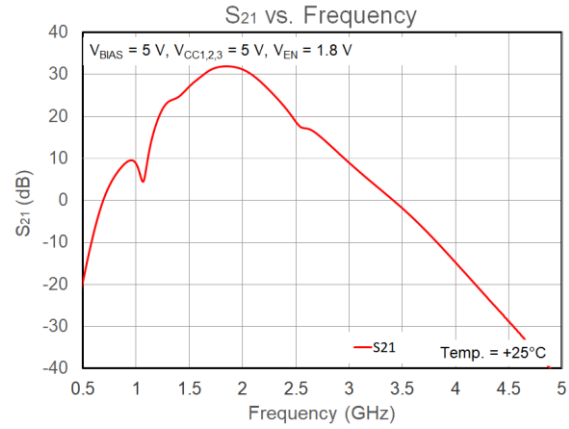
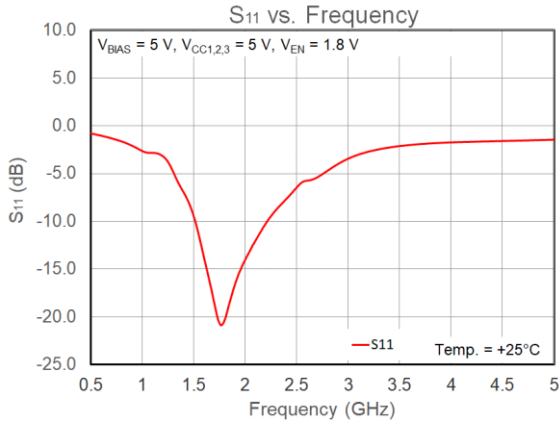

Test conditions unless otherwise noted: $V_{BIAS} = 5\text{ V}, V_{CC1,2,3} = 5\text{ V}, V_{EN} = 1.8\text{ V}$.

Pad Configuration and Description

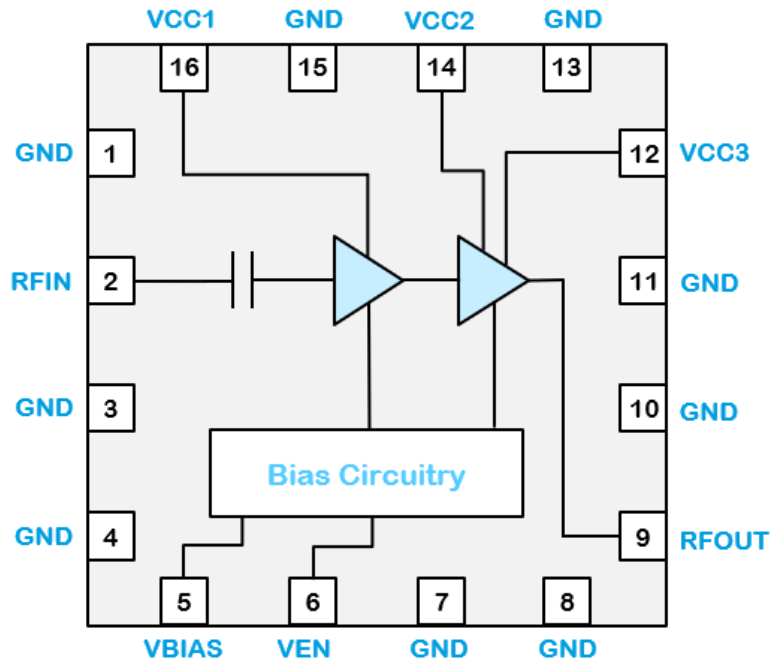

Top View

Pad No.	Label	Description
1, 3, 4, 7, 8, 10, 11, 13, 15	GND	Ground connection.
2	RF _{IN}	RF input, internally matched to 50Ω.
5	V _{BIAS}	Bias circuit supply voltage
6	V _{EN}	Amplifier enable voltage (regulated internally)
9	RF _{OUT}	RF output, internally matched to 50Ω. External DC blocking capacitor required
12	V _{CC3}	Second stage (Carrier) supply voltage
14	V _{CC2}	Second stage (Peaker) supply voltage
16	V _{CC1}	Driver stage supply voltage
Backside Paddle	GND	Ground connection. The back side of the package should be connected to the ground plan though as short of a connection as possible. PCB via holes under the device are recommended.

Package Marking and Dimensions

Marking: Pin 1 Indicator and Qorvo Logo
 Part Number – QPA9903
 Trace Code – XXXXXX Up to 8 Characters to be Assigned by sub-Contractor

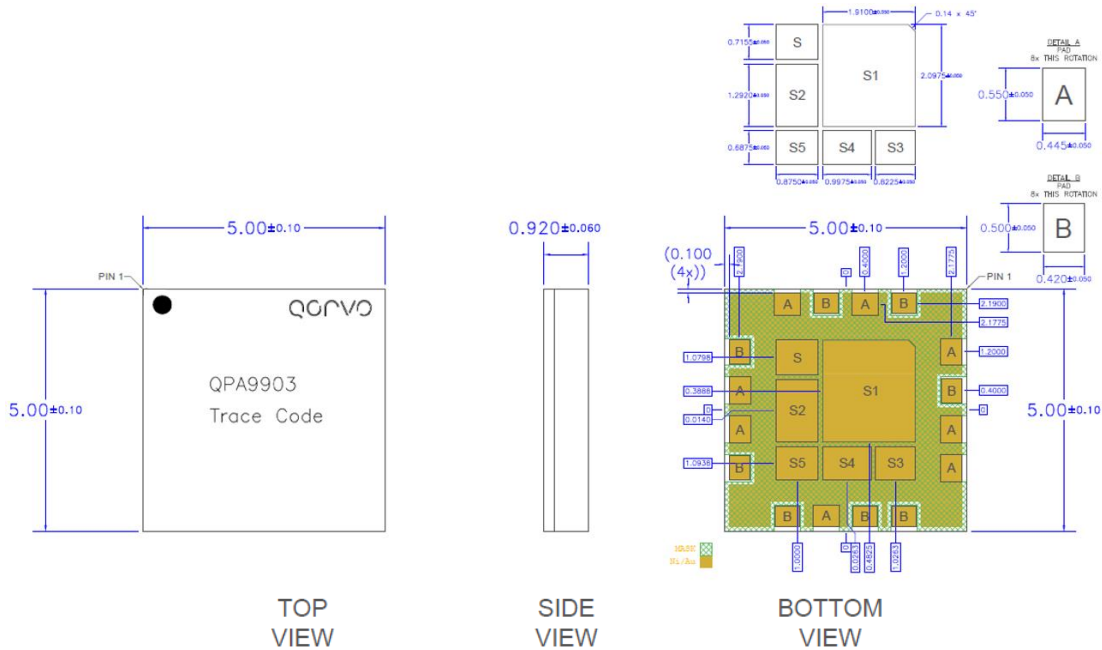

- Notes:
1. All dimensions are in millimeters. Angles are in degrees.
 2. The terminal #1 identifier and terminal numbering conform to JESD 95-1 SPP-012.
 3. Contact plating: ENEPIG

PCB Mounting Pattern

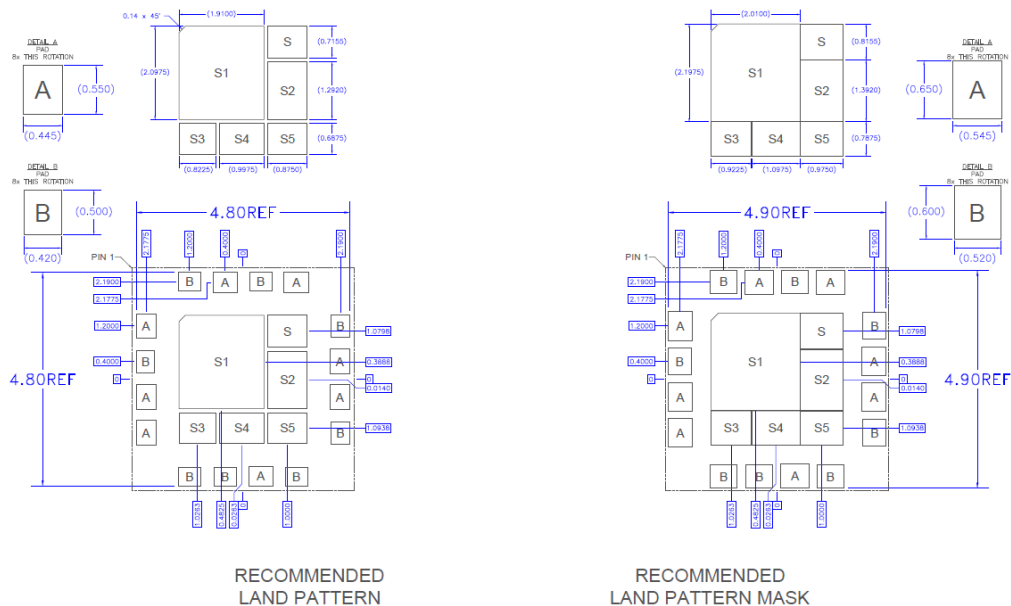

Evaluation Board PCB Information

PC Board Layout

PCB Material (stackup)

Layer	Name	Material	Thickness	Constant
1	Top Overlay			
2	Top Solder	Solder Resist	0.40 mil	3.5
3	Top Layer	Copper	1.40 mil	
4	Dielectric1	RO4350	20.00 mil	3.48
5	Bottom Layer	Copper	1.40 mil	

Total thickness: 23.2mil

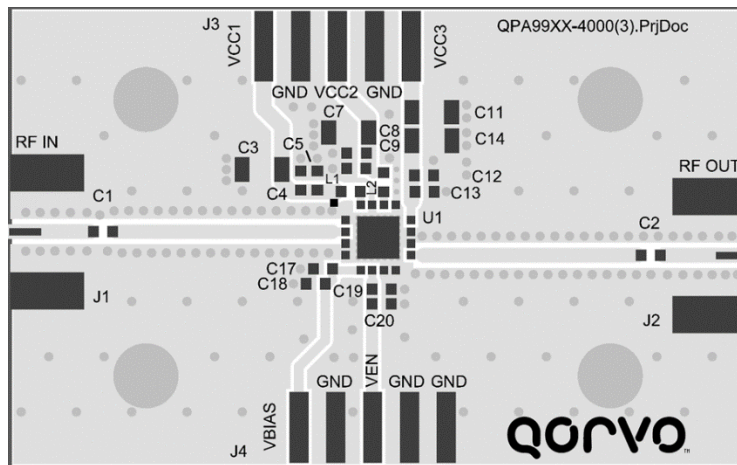

Notes:

1. All dimensions are in millimeters. Angles are in degrees.
2. Use 1 oz. copper minimum for top and bottom layer metal.
3. Via holes are required under the backside paddle of this device for proper RF/DC grounding and thermal dissipation. We recommend a 0.35mm (#80/.0135") diameter bit for drilling via holes and a final plated thru diameter of 0.25 mm (0.10").
4. Ensure good package backside paddle solder attach for reliable operation and best electrical performance.

Tape and Reel Information – Carrier and Cover Tape Dimensions

Tape and reel specifications for this part are also available on the Qorvo website.
 Standard T/R size = 2500 pieces on a 13" reel.

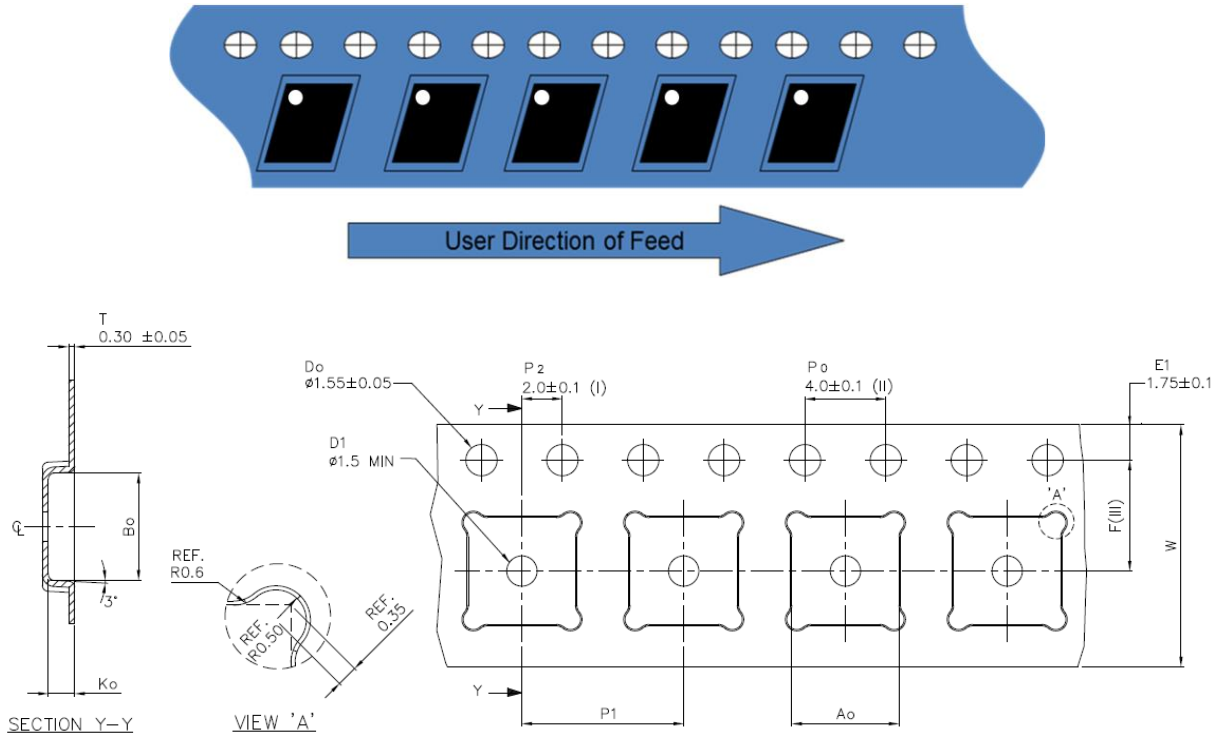

Feature	Measure	Symbol	Size (in)	Size (mm)
Cavity	Length	A0	0.209	5.3
	Width	B0	0.209	5.3
	Depth	K0	0.051	1.3
	Pitch	P1	0.315	8.0
Centerline Distance	Cavity to Perforation - Length Direction	P2	0.079	2.0
	Cavity to Perforation - Width Direction	F	0.217	5.5
Cover Tape	Width	C	0.362	9.2
Carrier Tape	Width	W	0.472	12

Tape and Reel Information – Reel Dimensions

Packaging reels are used to prevent damage to devices during shipping and storage, loaded carrier tape is typically wound onto a plastic take-up reel. The reel size is 13" diameter. The reels are made from high-impact injection-molded polystyrene (HIPS), which offers mechanical and ESD protection to packaged devices.

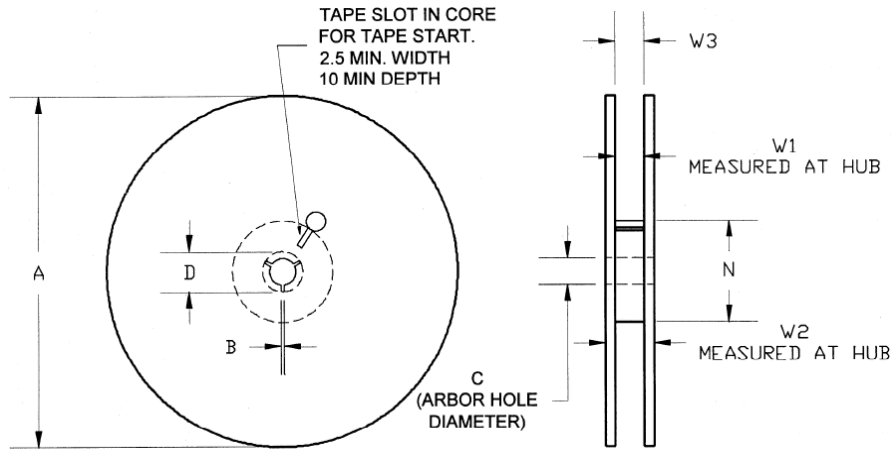

Feature	Measure	Symbol	Size (in)	Size (mm)
Flange	Diameter	A	12.992	330.00
	Thickness	W2	0.717	18.20
	Space Between Flange	W1	0.504	12.80
Hub	Outer Diameter	N	4.016	102.00
	Arbor Hole Diameter	C	0.512	13.00
	Key Slit Width	B	0.079	2.00
	Key Slit Diameter	D	0.795	20.2

Tape and Reel Information – Tape Length and Label Placement

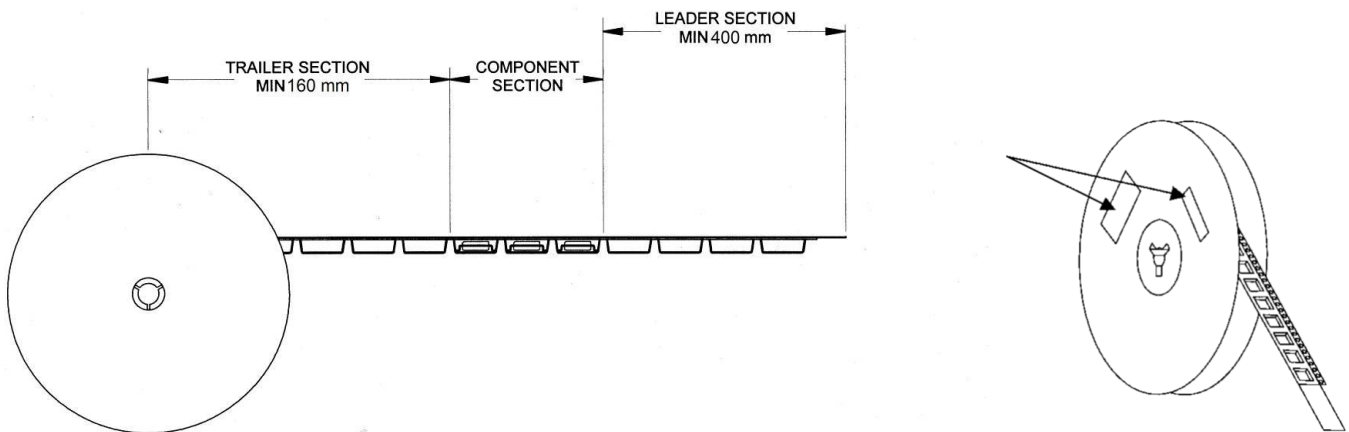

- Notes:
1. Empty part cavities at the trailing and leading ends are sealed with cover tape. See EIA 481.
 2. Labels are placed on the flange opposite the sprockets in the carrier tape.

Recommended Solder Temperature Profile

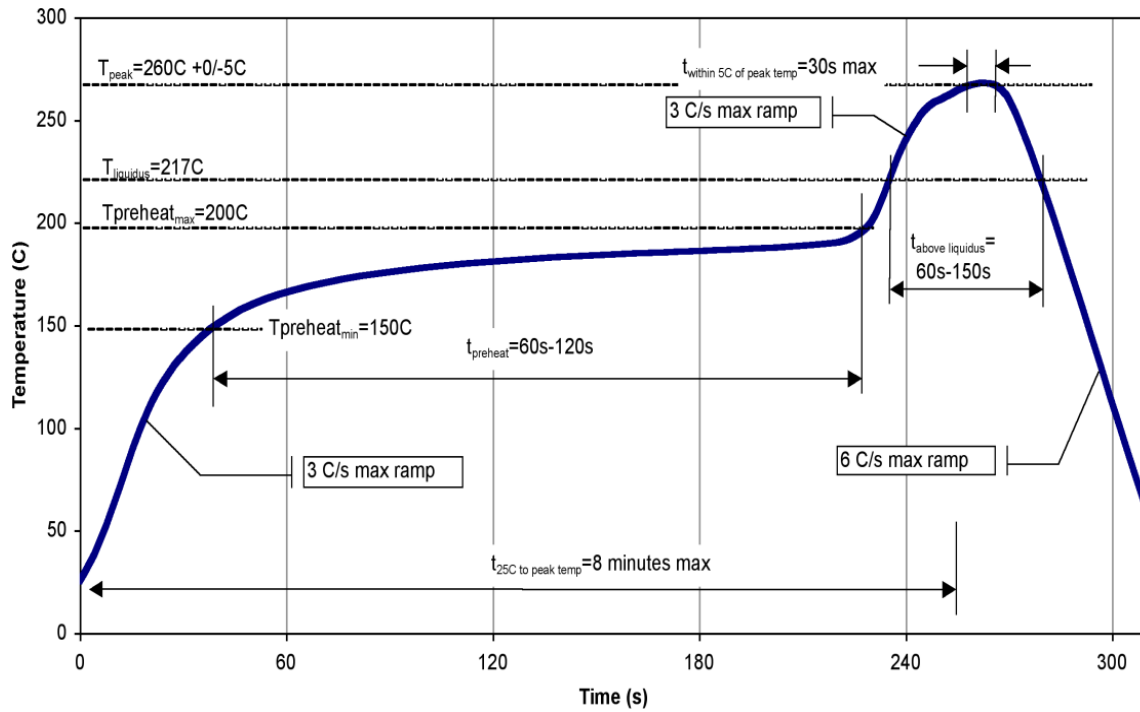

Handling Precautions

Parameter	Rating	Standard
ESD – Human Body Model (HBM)	1C	ESDA / JEDEC JS-001-2012
ESD – Charged Device Model (CDM)	C3	JEDEC JESD22-C101F
MSL – Moisture Sensitivity Level	3	IPC/JEDEC J-STD-020



Caution!
ESD-Sensitive Device

Solderability

Compatible with both lead-free (260°C max. reflow temp.) and tin/lead (245°C max. reflow temp.) soldering processes. Solder profiles available upon request.

Contact plating: ENEPIG

RoHS Compliance

This part is compliant with 2011/65/EU RoHS directive (Restrictions on the Use of Certain Hazardous Substances in Electrical and Electronic Equipment) as amended by Directive 2015/863/EU.

This product also has the following attributes:

- Product uses RoHS Exemption 7c-I to meet RoHS Compliance requirements.
- Halogen Free (Chlorine, Bromine)
- Antimony Free
- TBBP-A (C₁₅H₁₂Br₄O₂) Free
- PFOS Free
- SVHC Free

Contact Information

For the latest specifications, additional product information, worldwide sales and distribution locations:

Web: www.qorvo.com

Tel: 1-844-890-8163

Email: customer.support@qorvo.com

For technical questions and application information:

Email: appsupport@qorvo.com

Important Notice

The information contained herein is believed to be reliable; however, Qorvo makes no warranties regarding the information contained herein and assumes no responsibility or liability whatsoever for the use of the information contained herein. All information contained herein is subject to change without notice. Customers should obtain and verify the latest relevant information before placing orders for Qorvo products. The information contained herein or any use of such information does not grant, explicitly or implicitly, to any party any patent rights, licenses, or any other intellectual property rights, whether with regard to such information itself or anything described by such information. **THIS INFORMATION DOES NOT CONSTITUTE A WARRANTY WITH RESPECT TO THE PRODUCTS DESCRIBED HEREIN, AND QORVO HEREBY DISCLAIMS ANY AND ALL WARRANTIES WITH RESPECT TO SUCH PRODUCTS WHETHER EXPRESS OR IMPLIED BY LAW, COURSE OF DEALING, COURSE OF PERFORMANCE, USAGE OF TRADE OR OTHERWISE, INCLUDING THE IMPLIED WARRANTIES OF MERCHANTABILITY AND FITNESS FOR A PARTICULAR PURPOSE.**

Without limiting the generality of the foregoing, Qorvo products are not warranted or authorized for use as critical components in medical, life-saving, or life-sustaining applications, or other applications where a failure would reasonably be expected to cause severe personal injury or death.

Copyright 2021 © Qorvo, Inc. | Qorvo is a registered trademark of Qorvo, Inc.