

Rev	AWO #	Description	Date	Appr
-		RELEASED	10/7/03	

APPROVED: _____
 DATE: _____ TITLE: _____

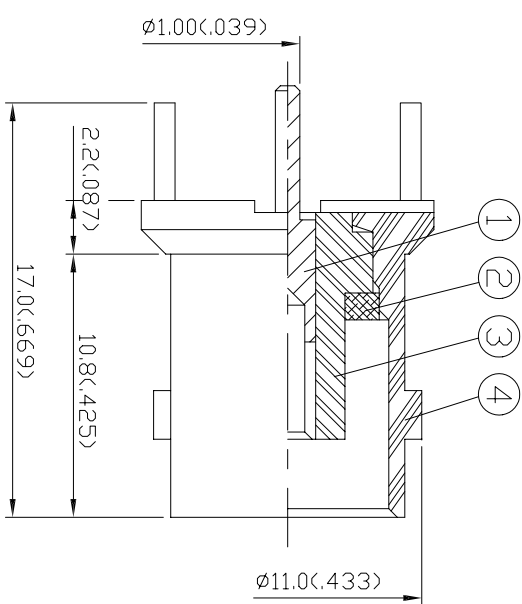
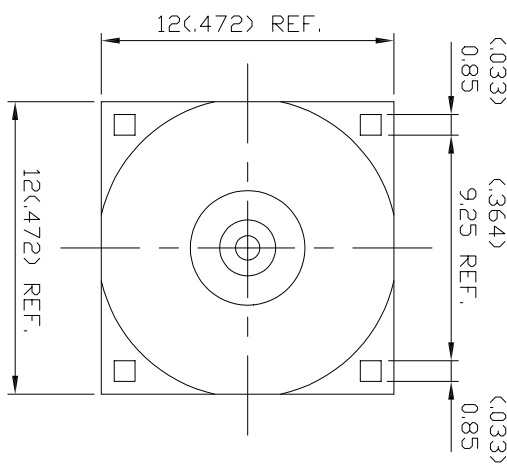
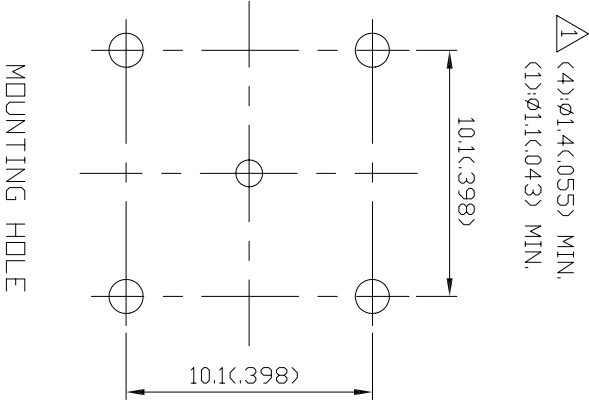

- NOTES: UNLESS OTHERWISE SPECIFIED
1. BODIES: BRASS PER JIS-C3604
 2. PIN: BRASS PER JIS-C3604
 3. INSULATION: TEFLON PER ASTM D1457 AND ASTM D1710
 4. CONNECTOR INTERFACE PER MIL-STD-348A
 5. PART TO BE CLEAN AND FREE OF BURRS

NO	DESCRIPTION	MATERIAL	Q'TY	FINISH
4	BODY	BRASS	1	NICKEL 100 μ" MIN.
3	INSULATION	TEFLON	1	NONE
2	SLEEVE	BRASS	1	NICKEL 100 μ" MIN.
1	PIN	BRASS	1	GOLD

UNLESS OTHERWISE SPECIFIED
 ALL DIMENSIONS ARE MM [INCHES]
 TOLERANCES: EXCEPT AS NOTED

INCHES	HOLES	DATE
.X ± .10	ØX ± .10	
.XX ± .020	ØXXX ± .015	
.XXX ± .015	ØXXX ± .010	

APPROVALS	DATE
DRAWN SLS	10/7/03
CHECKED	
APPROVED	

ADAM TECH
 909 Rahway Avenue, Union, NJ 07083
 Phone: 908-687-5000 Fax: 908-687-0214

TITLE: RF CONNECTOR, TYPE BNC, PCB VERTICAL, 75 OHM

SIZE	PART NO.	SCALE	SHEET	REV.
X	RF-11-T-00-75	NTS	1 OF 1	