

8830 A

AC axial compact fan



ebm-papst St. Georgen GmbH & Co. KG

Hermann-Papst-Straße 1

D-78112 St. Georgen

Phone +49 7724 81-0

Fax +49 7724 81-1309

info2@de.ebmpapst.com

www.ebmpapst.com

Nominal data

Type	8830 A	
Phase		1~
Nominal voltage	VAC	115
Frequency	Hz	60
Speed	min ⁻¹	1950
Power input	W	8.0
Min. ambient temperature	°C	-10
Max. ambient temperature	°C	80
Air flow	m ³ /h	34
Sound power level	B	4.3
Sound pressure level	dB(A)	29

ml = max. load · me = max. efficiency · fa = running at free air · cs = customer specs · cu = customer unit
Subject to alterations



Technical features

General description	<p>AC voltage fan with external rotor motor shaded-pole motor. Protected from overload by impedance protection.</p> <p>Fan housing and fan impeller made of metal.</p> <p>Inlet over bars. Rotational direction clockwise looking at rotor.</p> <p>Electrical connection to 2 flat plugs 2.8 x 0.5 mm.</p> <p>Fan housing with grounding lug and tapping screw M4 x 8 (TORX).</p> <p>Dimensions 490 g.</p> <p>Optionally available with electrical connection to single strands.</p> <p>Optionally available with air exhaust over bars, deliverable with clockwise direction of rotation.</p> <p>Please note our new ACmaxx series. With identical fastening dimensions and voltages, this series achieves higher energy efficiency.</p>
Mass	0.490 kg
Dimensions	80 x 80 x 38 mm
Material of impeller	Metal
Housing material	Metal
Direction of air flow	Inlet over bars
Direction of rotation	Right, looking at rotor
Bearing	Sintec sleeve bearing system
Lifetime L10 at 40 °C	62500 h
Lifetime L10 at maximum temperature	25000 h
Connection line	2 flat plugs 2.8 x 0.5 mm
Motor protection	Protected from overload using impedance protection
Approval	VDE, CSA, UL, CE

Product drawing

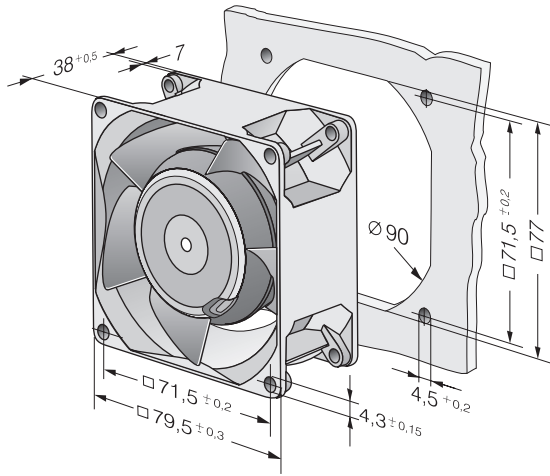

Charts: Air flow

