

DETAILS

Product Number	FN14645_STELLA-T4
Family	STELLA
Type	Pack
Color	black
Diameter	90 mm
Height	26,9 mm
Style	round
Optic Material	Silicone
Holder Material	
Fastening	screw
Status	production ready
ROHS Compliant	Yes
Date Updated	2/02/2017



OPTICAL PROPERTIES

LED	Viewing Angle	Light Beam	Efficiency	cd/lm	Connector
VERO18	sim: Asymmetric	Streetlight	sim: 91 %	-	-
V10 Gen7	sim: Asymmetric	Streetlight	sim: 94 %	sim: 0.510	Bender Wirth: 434 Typ Z1
V22 Gen7	sim: asym	Streetlight	sim: 94 %	sim: 0.516	Bender Wirth: 431 Typ Z1
V18 Gen7	sim: Asymmetric	Streetlight	sim: 94 %	sim: 0.510	-
V13 Gen7	sim: Asymmetric	Streetlight	sim: 95 %	sim: 0.495	Bender Wirth: 477 Typ Z1
CLL03x/CLU03x	sim: Asymmetric	Streetlight	sim: 93 %	-	-
CLL04x/CLU04x	asymmetric deg	Streetlight	91 %	0.470	-
CLL04x/CLU04x	sim: Asym	Streetlight	sim: 91 %	sim: 0.500	Bender Wirth: 431 Typ Z1
CXA/B 25xx	sim: Asymmetric	Streetlight	sim: 92 %	-	-
CXA/B 1830	sim: Asymmetric	Streetlight	sim: 93 %	-	-
CXA/B 30xx	sim: Asymmetric	Streetlight	-	-	-
LUXEON CoB 1211	Asymmetric deg	Streetlight	92 %	0.500	-
LUXEON CoB 1208	Asymmetric deg	Streetlight	93 %	0.500	-
LUXEON CoB 1216	Asym deg	Streetlight	92 %	0.480	-
CXM-14	asymmetric deg	Streetlight	94 %	0.500	-
CXM-18	asymmetric deg	Streetlight	94 %	0.500	-
CXM-22	sim: Asym	Streetlight	sim: 91 %	sim: 0.490	Bender Wirth: 431 Typ Z1
Soleriq P9	asymmetric deg	Streetlight	94 %	0.710	-
Soleriq S13	asymmetric deg	Streetlight	93 %	0.530	-
Soleriq P13	asymmetric deg	Streetlight	93 %	0.490	-
Soleriq S19	asymmetric deg	Streetlight	93 %	0.490	-
MJT COB LES 22	Asymmetric deg	Streetlight	89 %	0.490	Bender Wirth: 431 Typ Z1
MJT COB LES 14.5	asym deg	Streetlight	90 %	0.600	Bender Wirth: 433 Typ Z1
SLE G5 LES15	Asymmetric deg	Streetlight	91 %	0.500	-

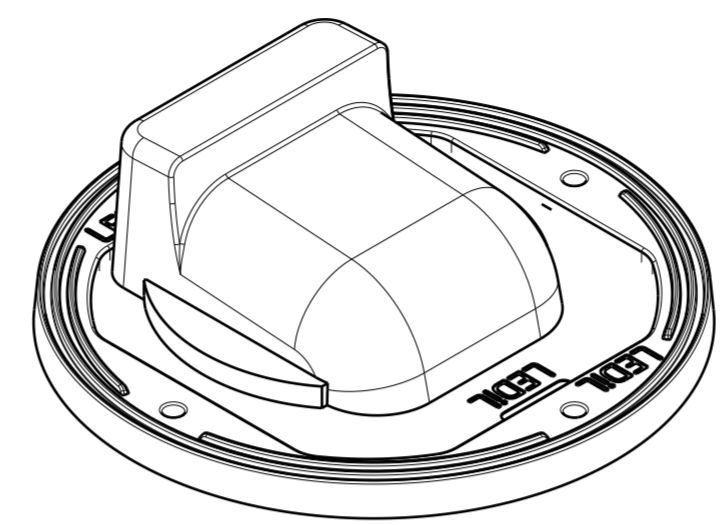
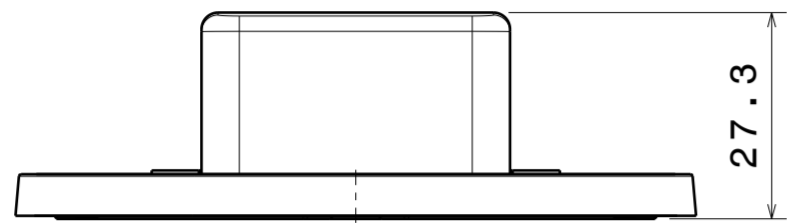

Isometric view
Scale: 1:1

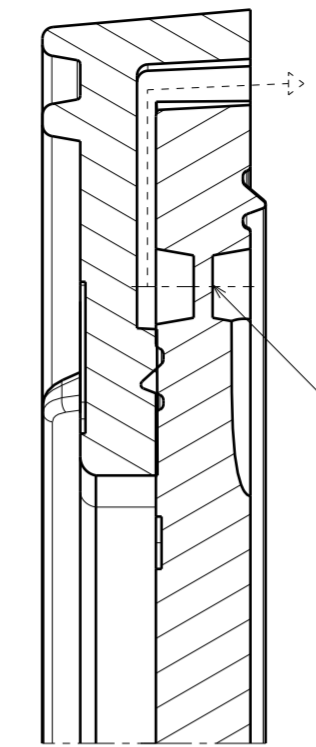

Venting pipe:
Piercing this membrane
will Allow lens breathing

Section view A-A
Scale: 5:1

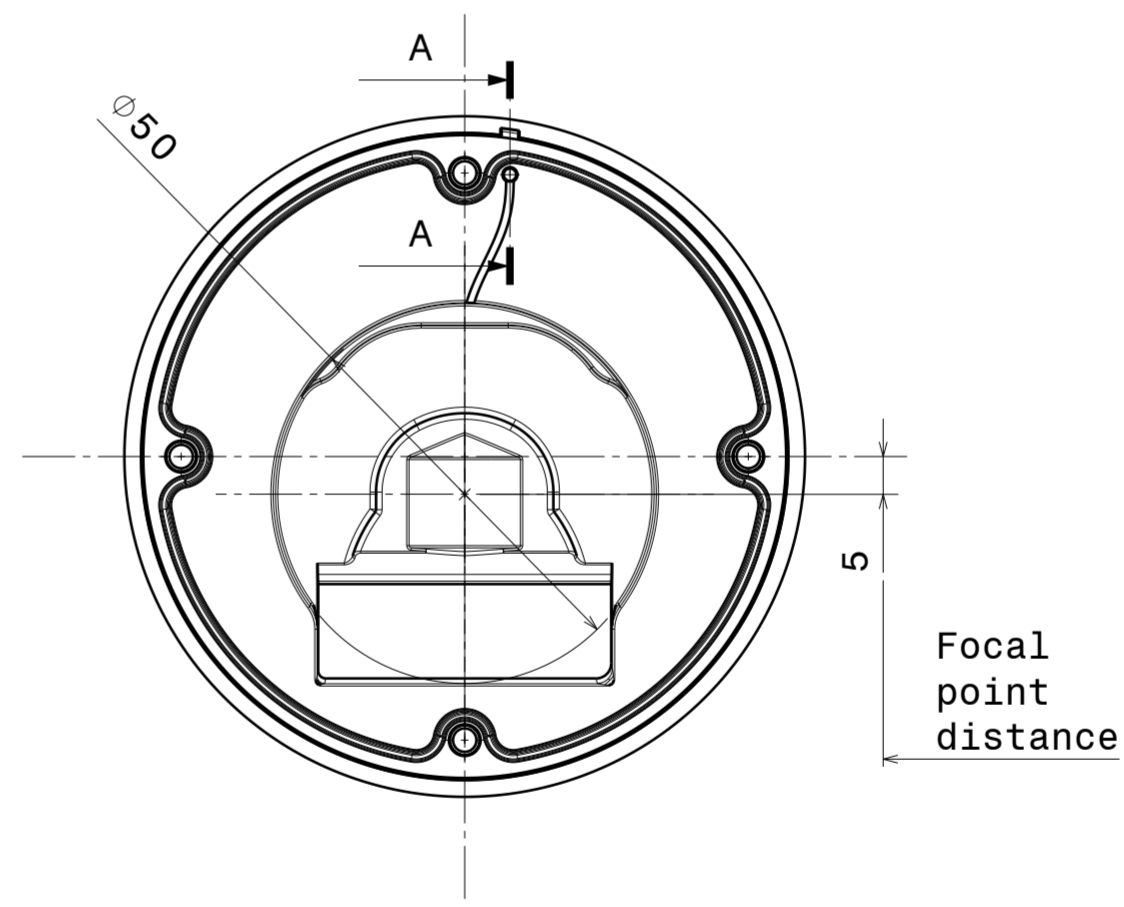
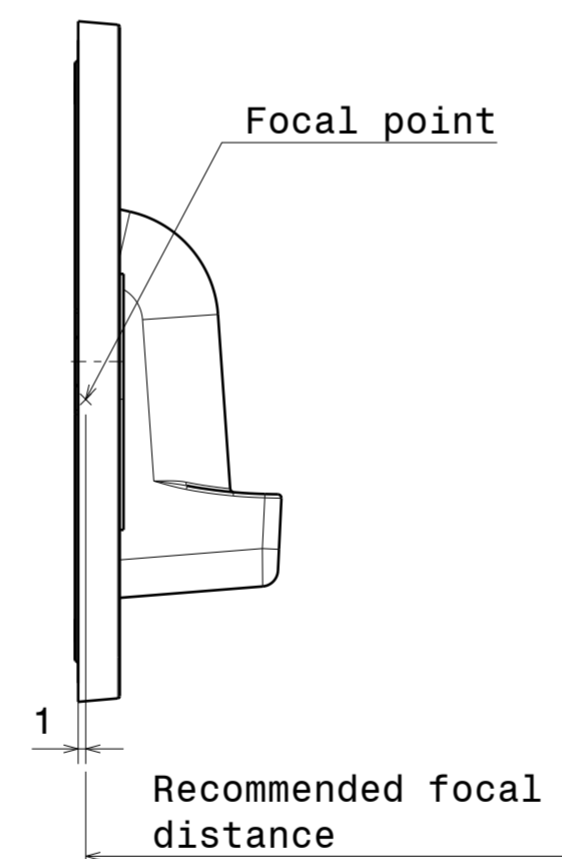
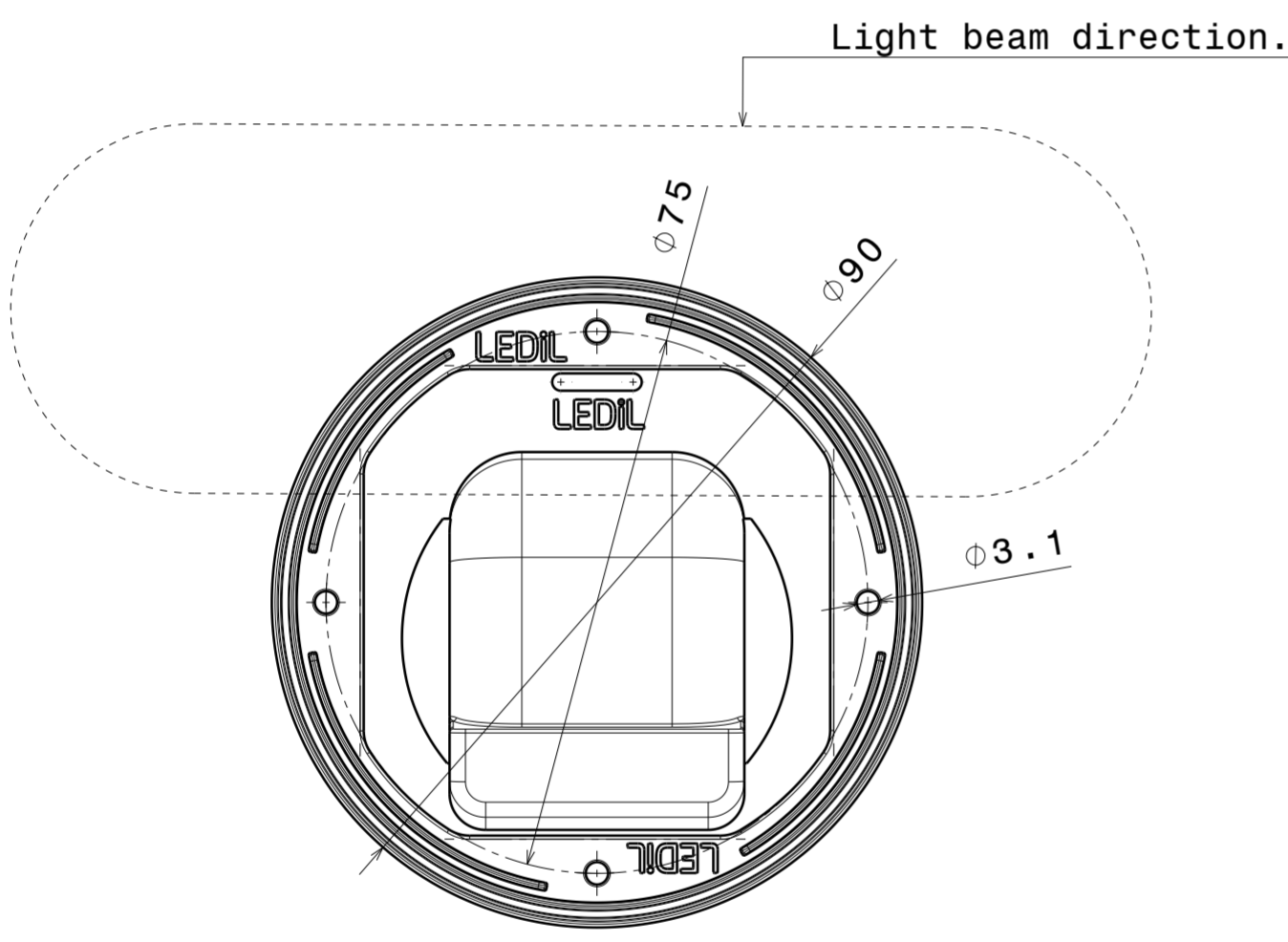

NOTE: Maximum recommended tightening torque for STELLA-FRAME is 0,4Nm

INDEX	PART NO	DESCRIPTION	MATERIAL	COLOUR
1	F14514	STELLA-T4	Optical grade LSR	
2	C13322	STELLA-FRAME	PA	black

Tolerances if not otherwise shown
According to DIN ISO 2768-1
Linear measures: class V
Please note that due to the elasticity of
products made of silicone actual measured
values may vary, and therefore typical
tolerance values may not be applied.

THIRD ANGLE PROJECTION:

This drawing is the property
of LEDiL Oy. It may not be
reproduced, copied or
communicated without a written
agreement with LEDiL Oy.

LEDiL LediL Oy
Salorankatu 10
FIN 24240 SALO
Finland

DRAWING TITLE
STELLA-T4 datasheet

SIZE	PART NUMBER				
A2	FN14645				
SCALE	1:1	WEIGHT	-	SHEET	1/1

Luminaire: Ledil Oy FN14645_STELLA-T4+_Bender+Wirth 434 Typ Z1_BRIDGELUX_V10_Gen7_SIMULATED
Lamps: 1 x BRIDGELUX V10 Gen7

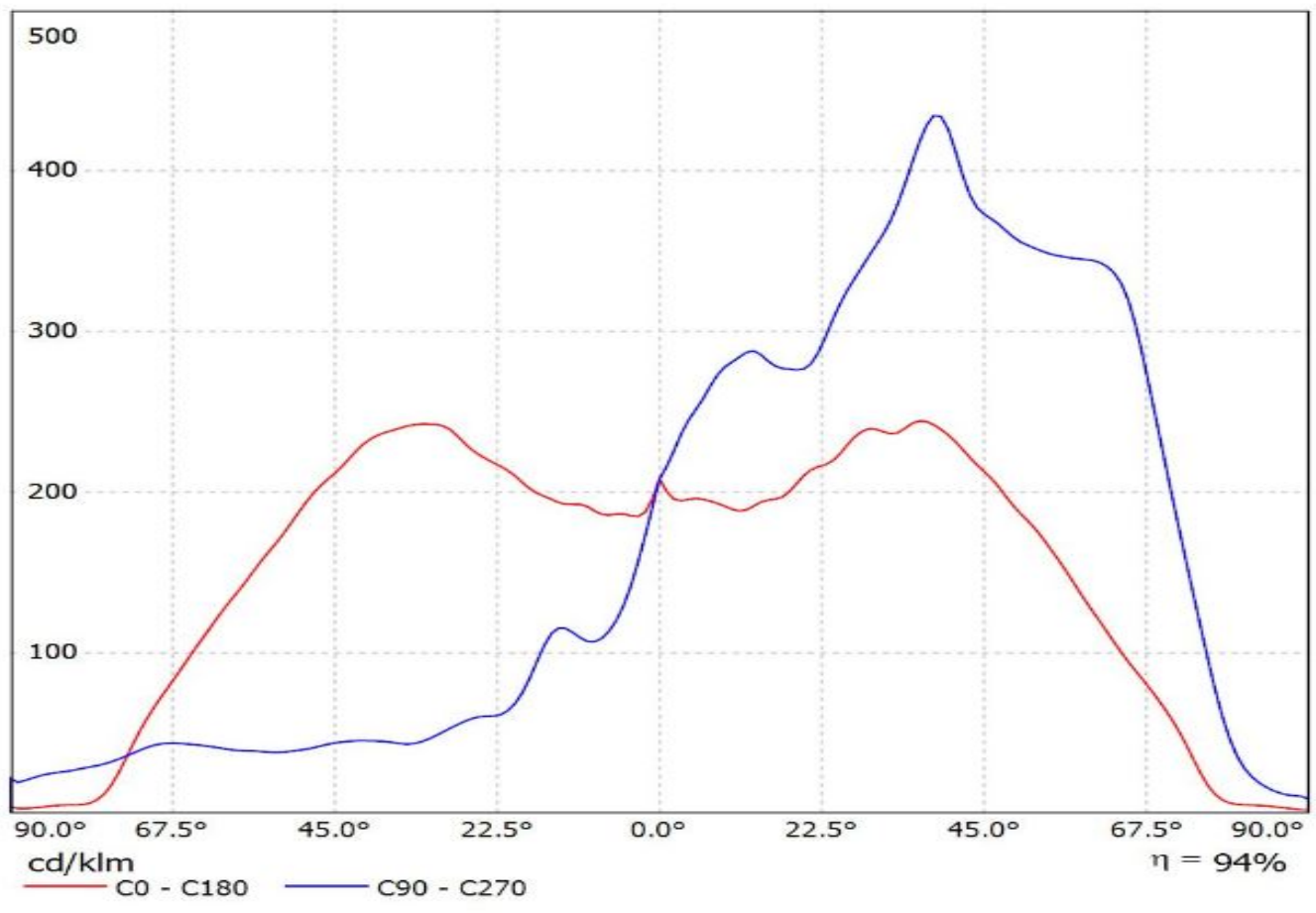

Luminaire: Ledil Oy FN14645_STELLA-T4_Bridgelux_V22_Gen7_SIMULATED FN14645_STELLA-T4_Bridgelux_V22_Gen7_SIMULATED
Lamps: 1 x FN14645_STELLA-T4_Bridgelux_V22_Gen7_SIMULATED

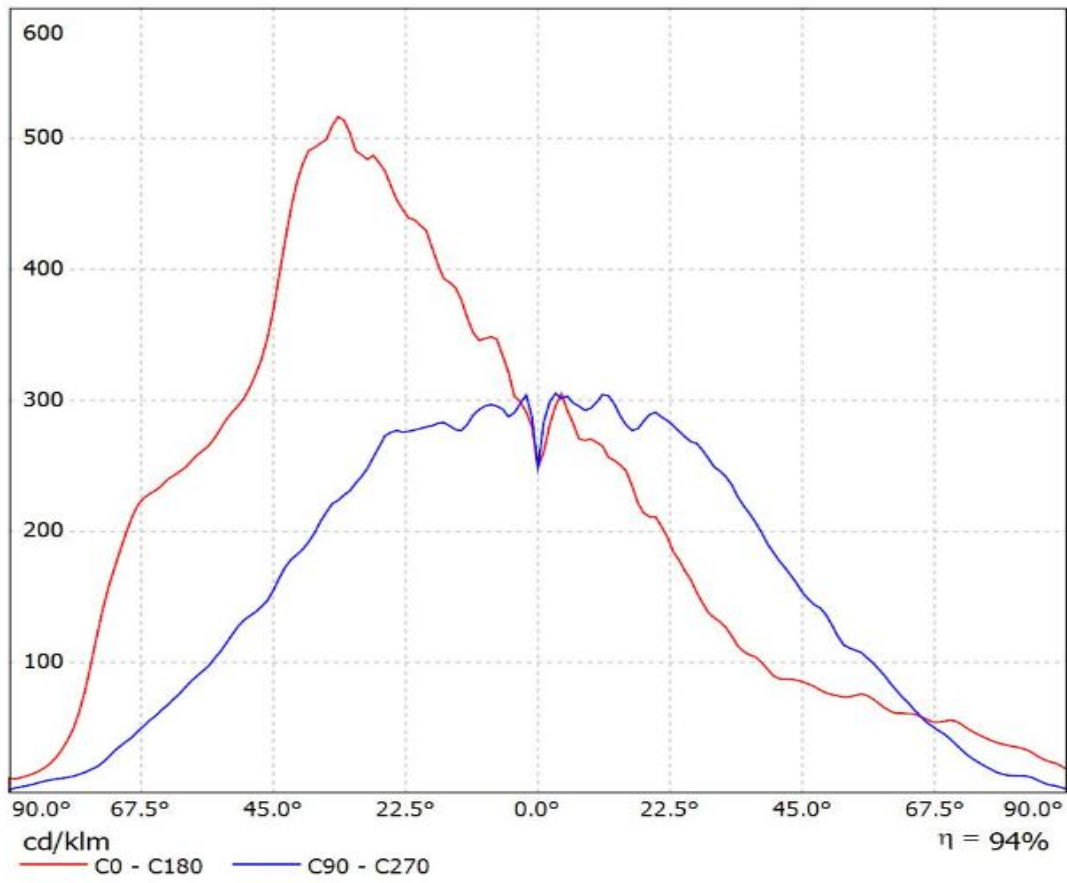

Luminaire: Ledil Oy FN14645_STELLA-T4_BRIDGELUX_V18_Gen7_SIMULATED
Lamps: 1 x BRIDGELUX V10 Gen7

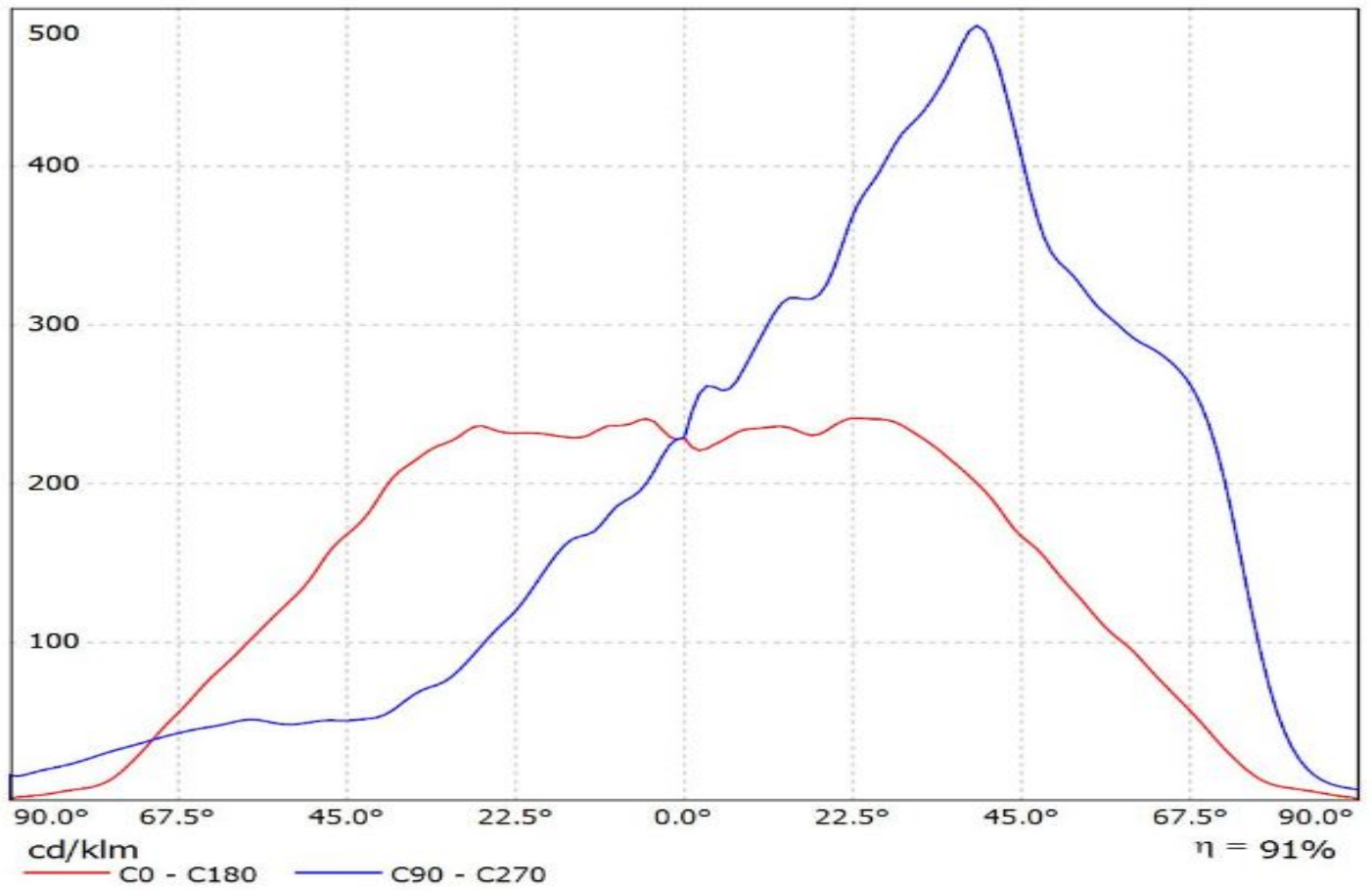

Luminaire: LEDiL Oy FN14645_STELLA-T4_(CLU046)
Lamps: 1 x Citizen_CLU046_1354.66lm@250mA_P=8.06877W_I=0.2499A

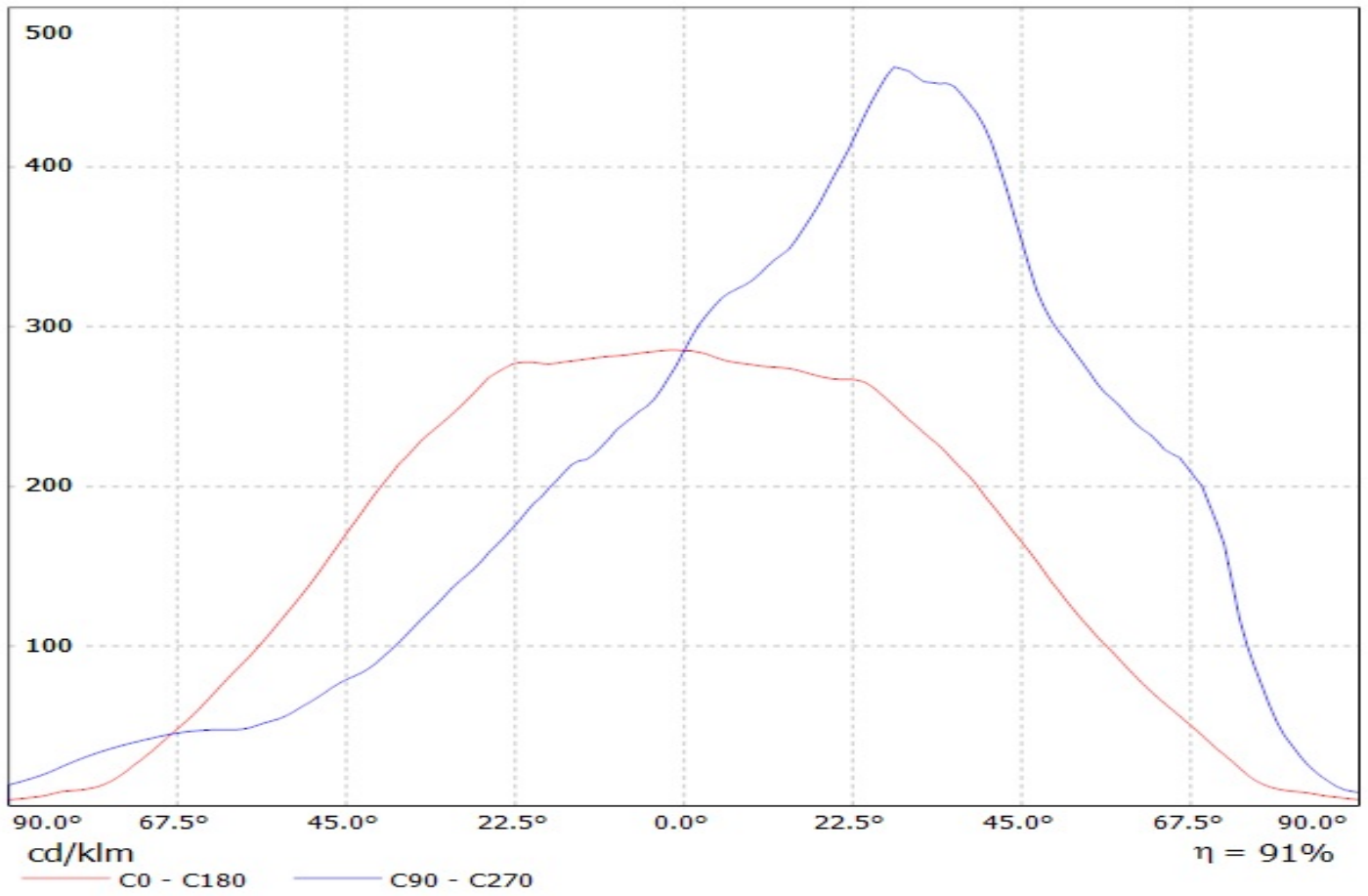

Luminaire: Ledil Oy FN14645_STELLA-T4_(CLU048)_(B&W_431_Type_Z1)_SIMULATED
Lamps: 1 x Citizen CLU048-1818C4-303M2K1 + Bender & Wlrth 431 Type Z1

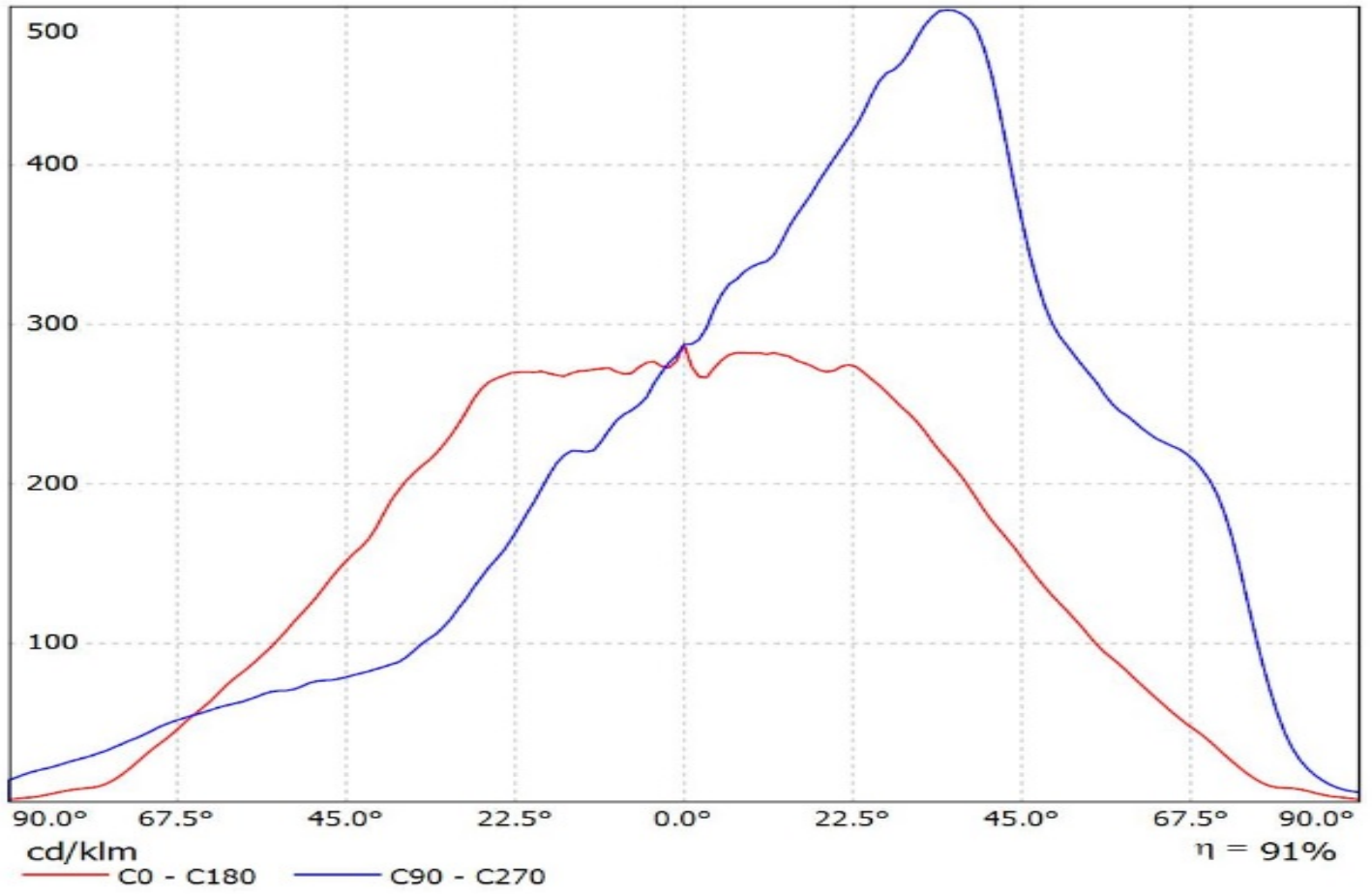

Ledil FN14645_STELLA-T4_(COB1211) / LDC (Linear)

Luminaire: Ledil FN14645_STELLA-T4_(COB1211)

Lamps: 1 x LUXEON_COB1211_(LHC1-2790-1211)_955.193lm@250mA_CCT=2700K_P=8W_I=0.25A

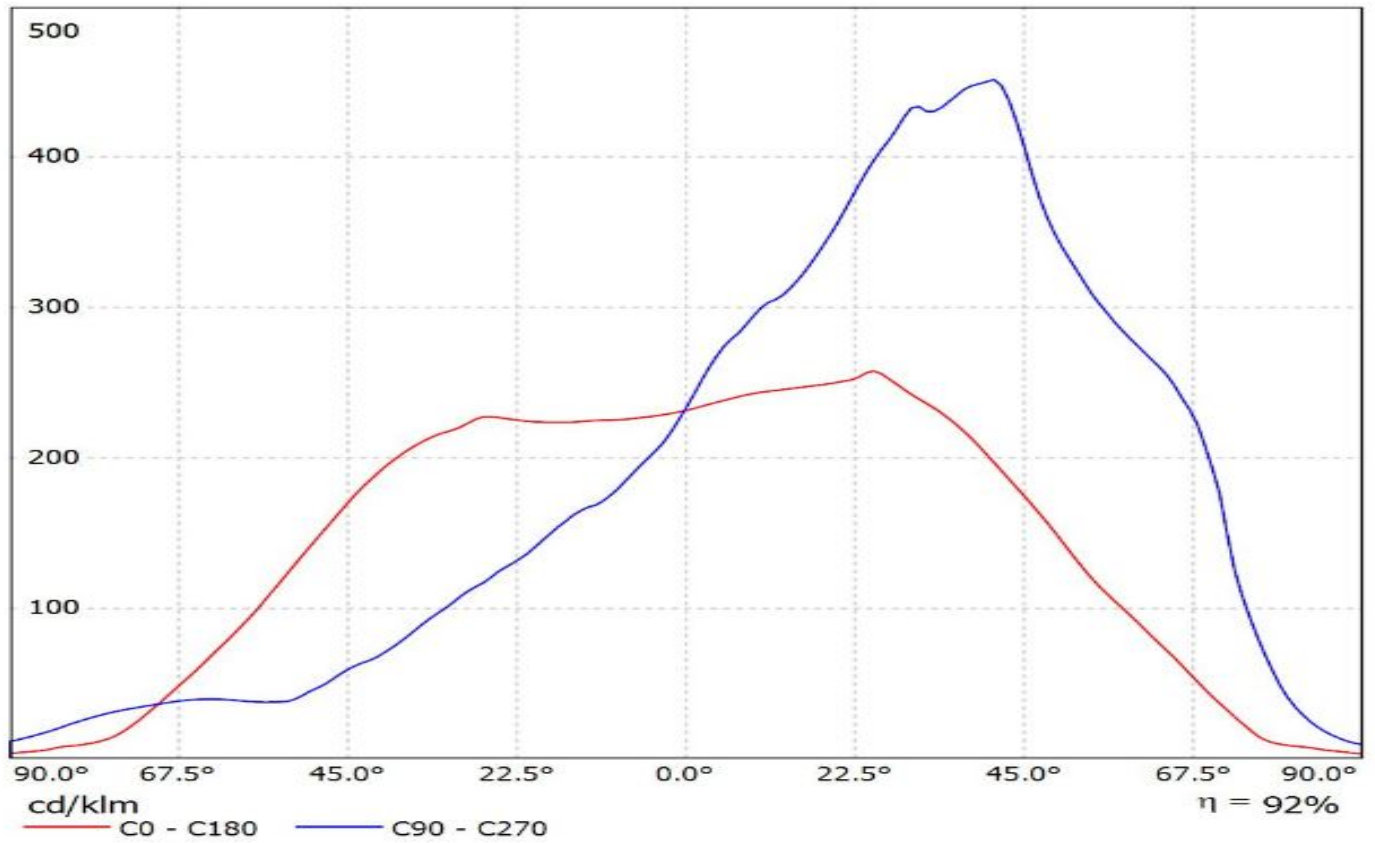

Ledil FN14645_STELLA-T4_(COB1208) / LDC (Linear)

Luminaire: Ledil FN14645_STELLA-T4_(COB1208)

Lamps: 1 x LUXEON_COB1208_(LHC1-3090-1208)_1100.7lm@250mA_CCT=3215K_P=8.3W_I=0.25A

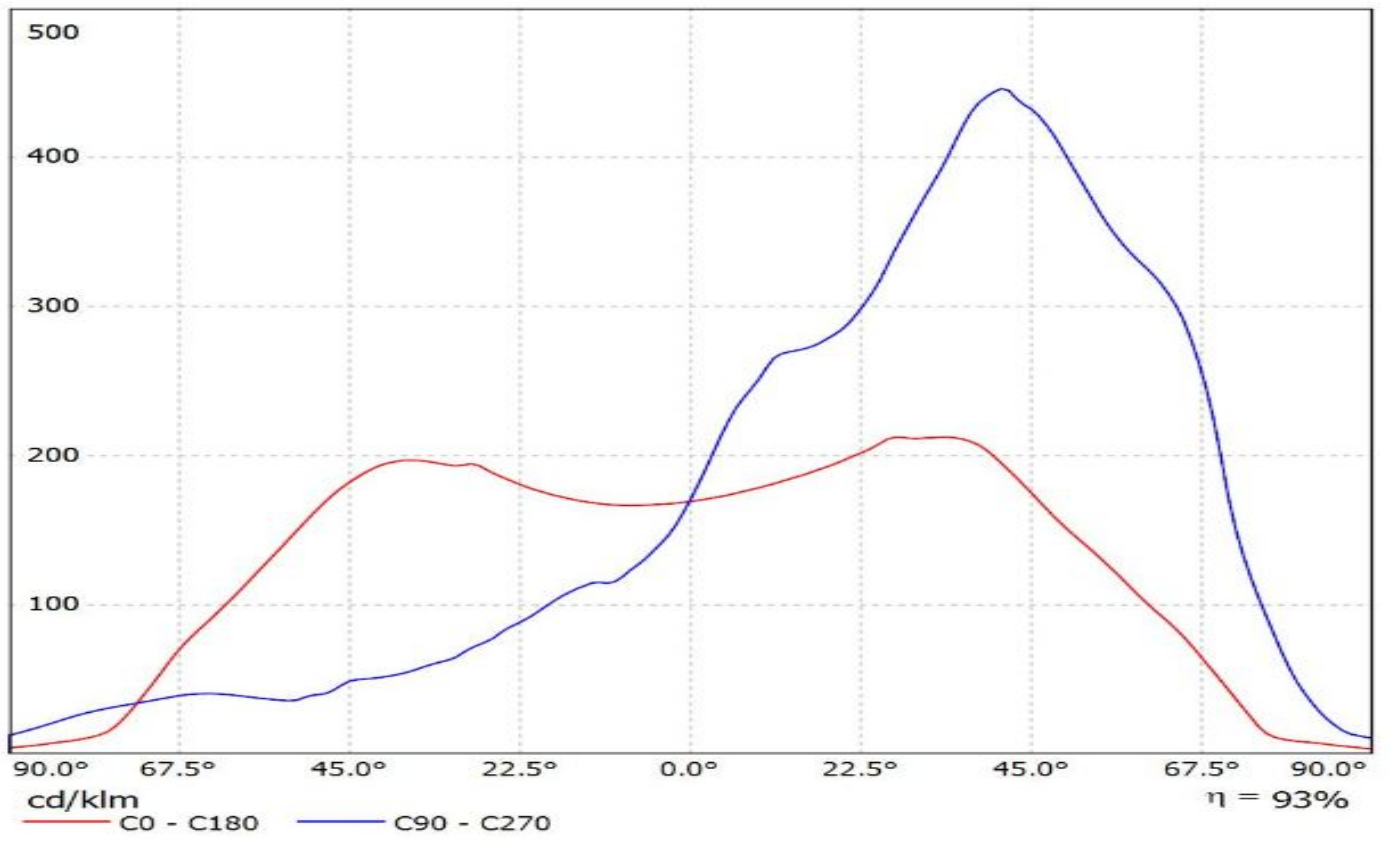

Luminaire: Ledil FN14645_STELLA-T4_(CoB_1216)

Lamps: 1 x Luxeon_CoB_1216_(L2C2-40801216E2300)_1468.12lm@250mA_P=7.9868W_I=0.25A

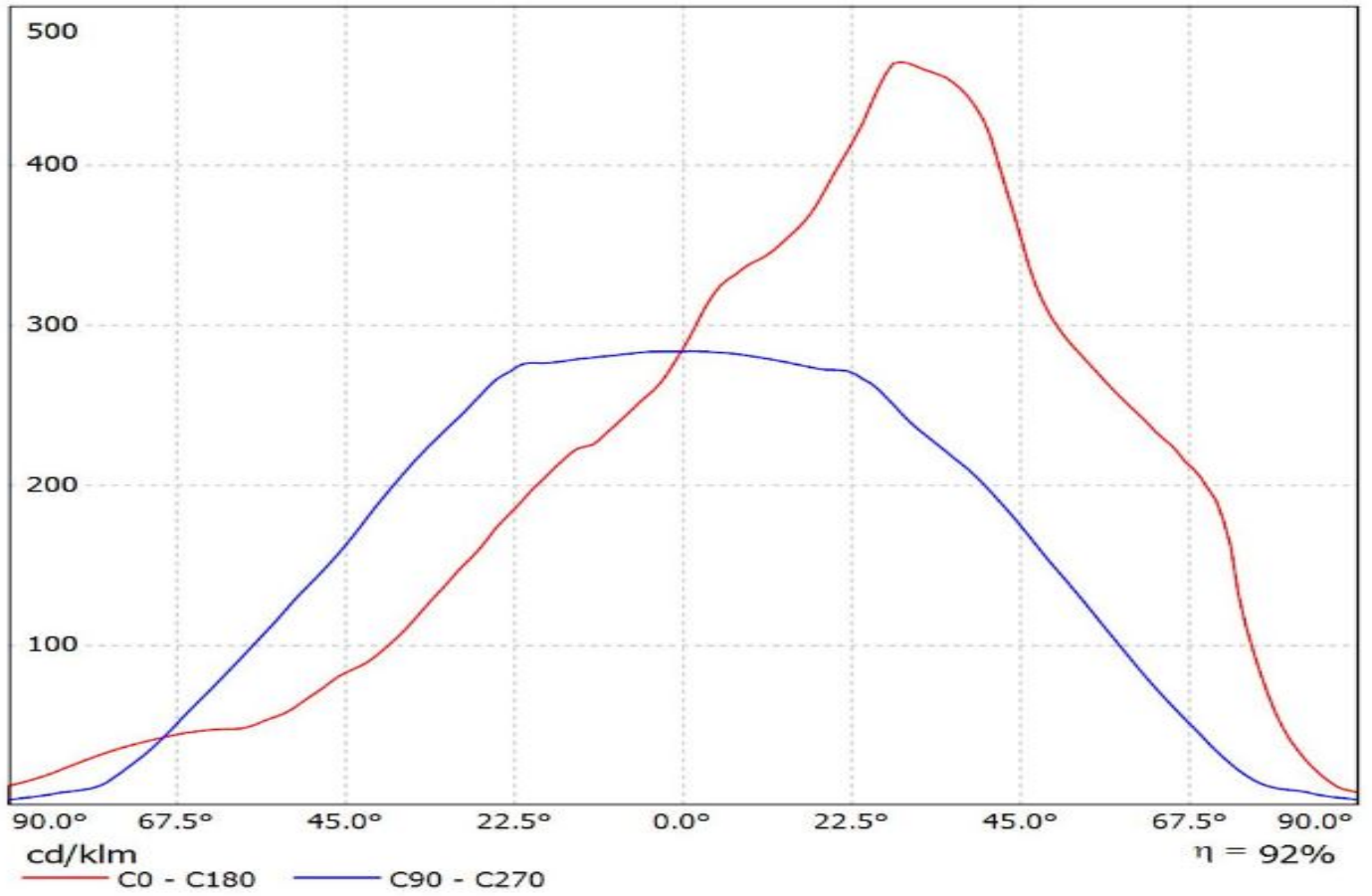

Luminaire: Ledil FN14645_STELLA-T4_(CXM-14)

Lamps: 1 x Luminus_XNOVA-CXM-14_1156.79lm@250mA_U=8.3W_I=0.25A

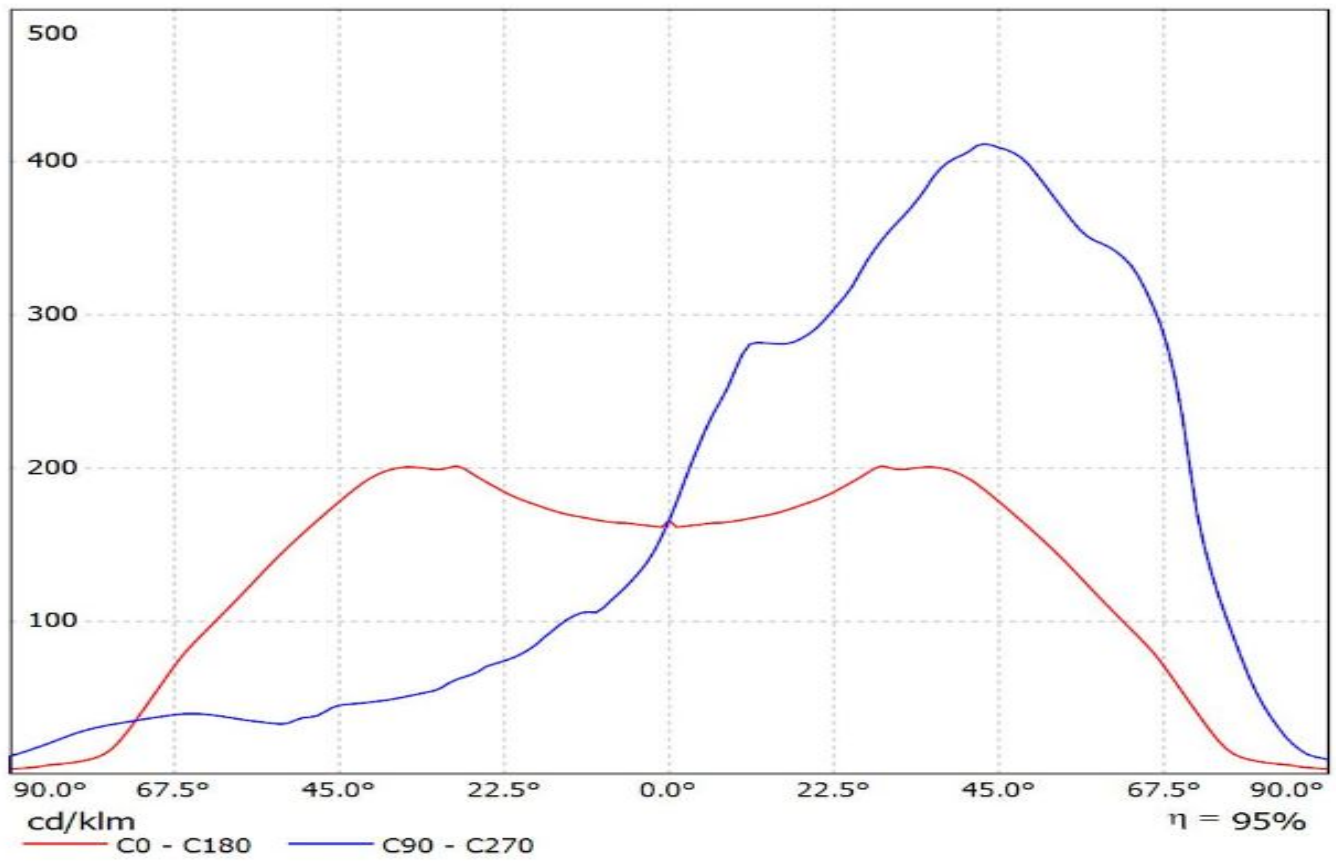

Luminaire: Ledil FN14645_STELLA-T4_(CXM-18)

Lamps: 1 x Luminus_XNOVA-CXM-18_921.635lm@250mA_U=8.12W_I=0.25A

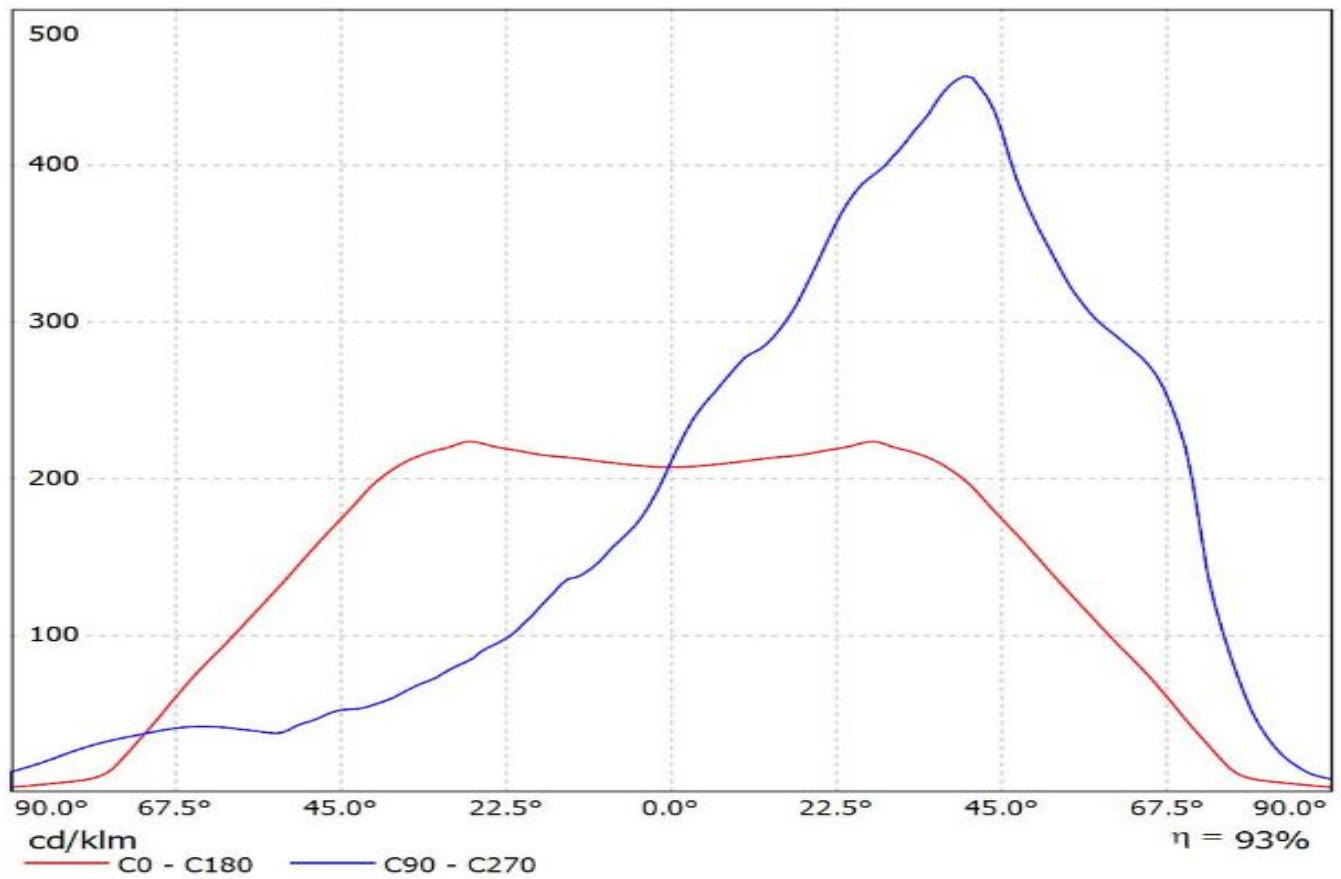

Luminaire: Ledil Oy FN14645_STELLA-T4_(CXM-22)_(B&W_431_Type_Z1)_SIMULATED
Lamps: 1 x Luminus CXM-22 + Bender & Wirth 431 Type Z1

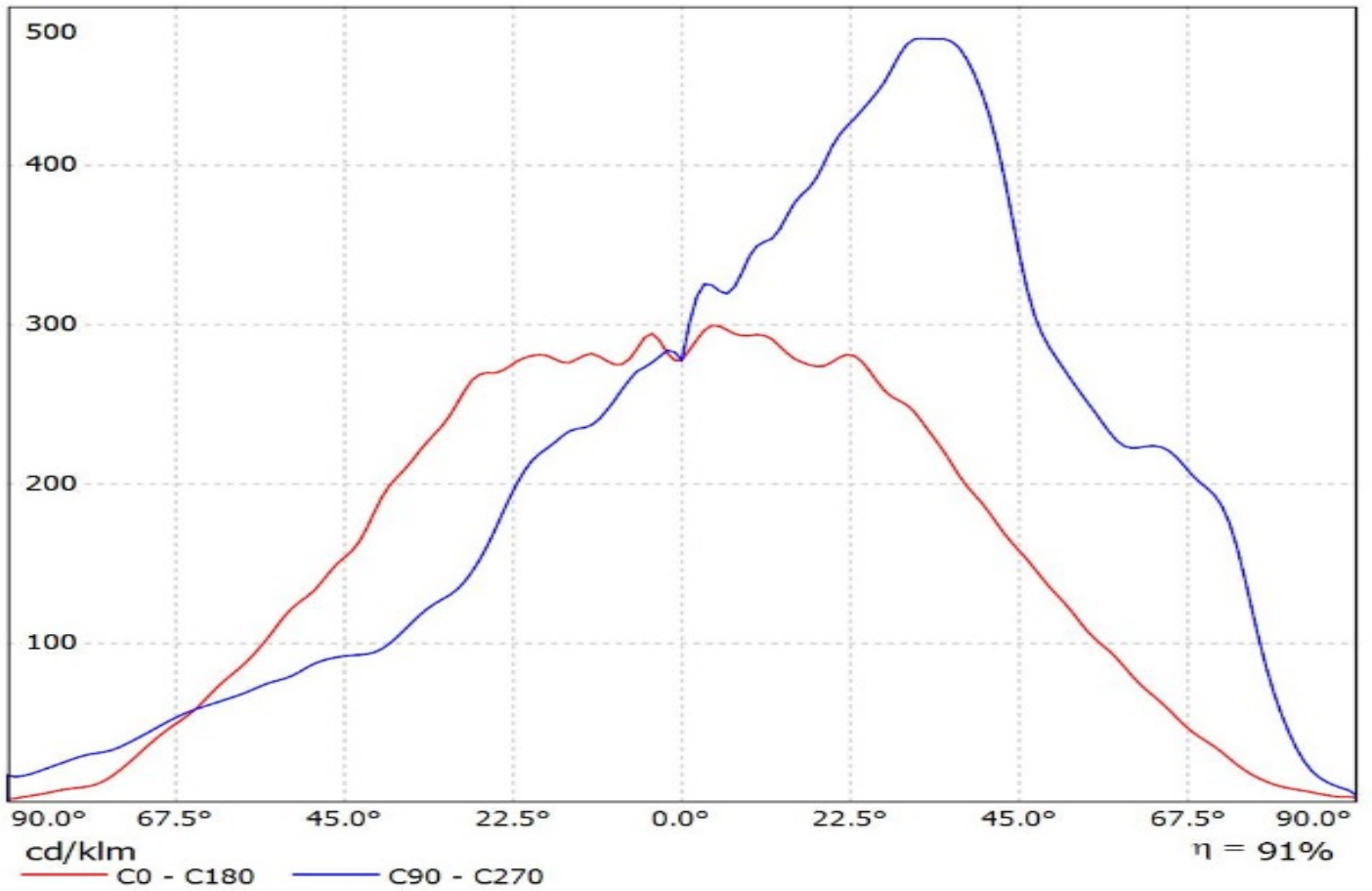

Luminaire: LEDiL Oy FN14645_STELLA-T4_(Soleriq_P9)

Lamps: 1 x Osram_Soleriq_P9_(GW_MAFJB1.EM)_883.856lm@250mA_CCT=4372K_P=6.86301W_I=0.2498A

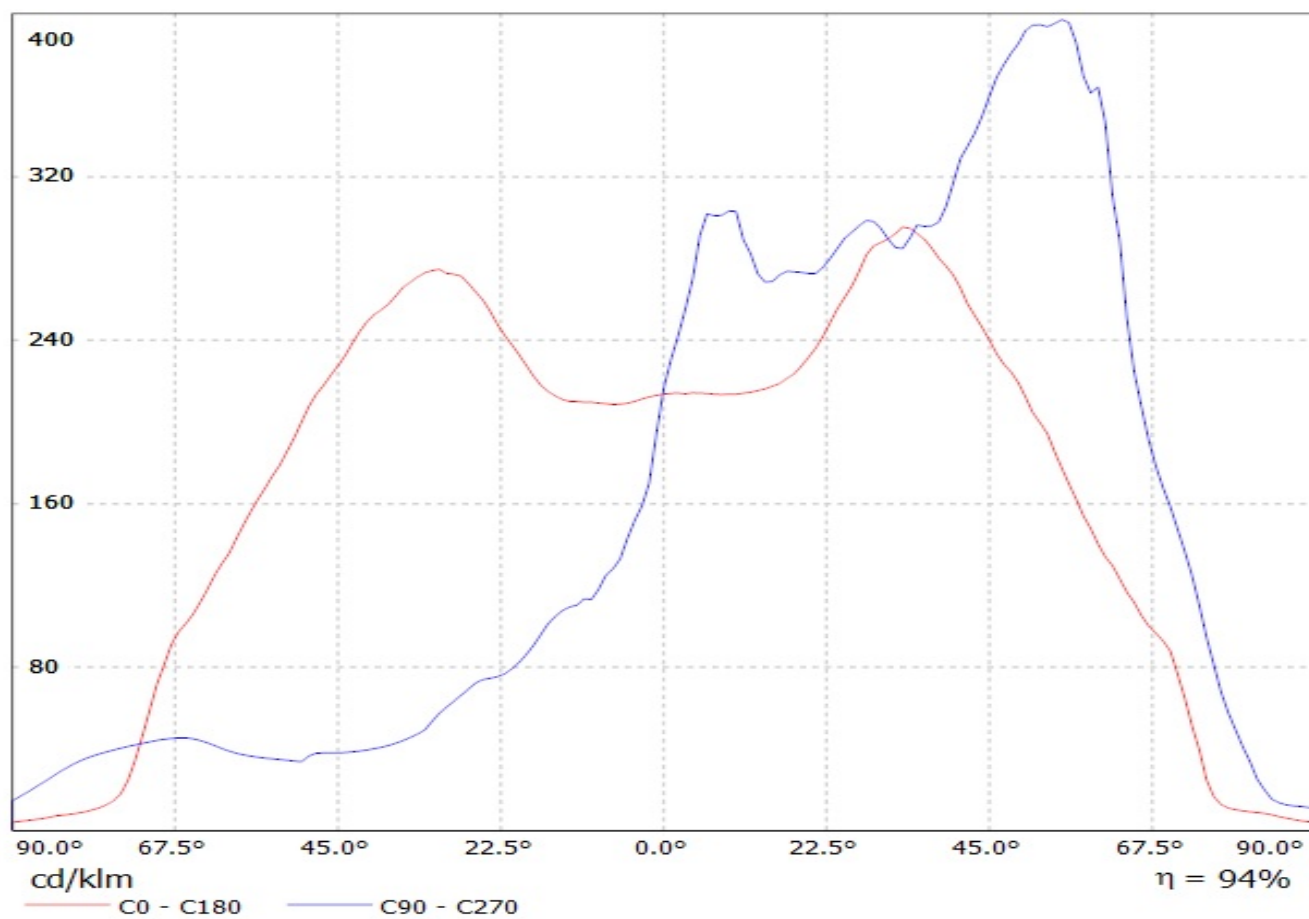

Luminaire: LEDiL Oy FN14645_STELLA-T4 (Soleriq_S13)

Lamps: 1 x Osram_Soleriq_S13_(GW_KAGHB1.EM)_867.588lm@250mA_P=7.35456W_I=0.2499A

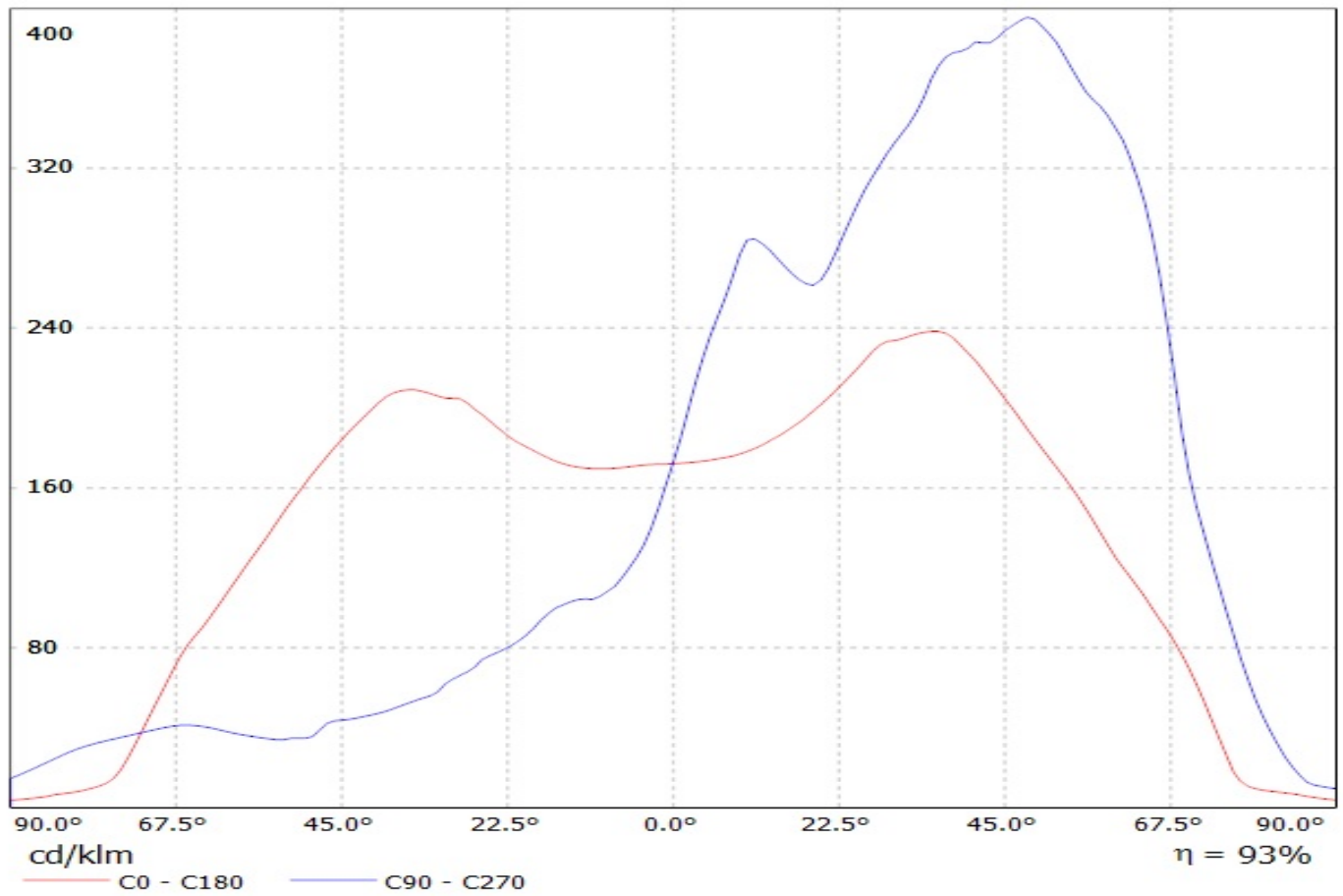

Luminaire: LEDiL Oy FN14645_STELLA-T4_(Soleriq_P13)

Lamps: 1 x Osram_Soleriq_P13_(GW_MAGMB1.EM)_935.757lm@250mA_P=8.73875W_I=0.2498A

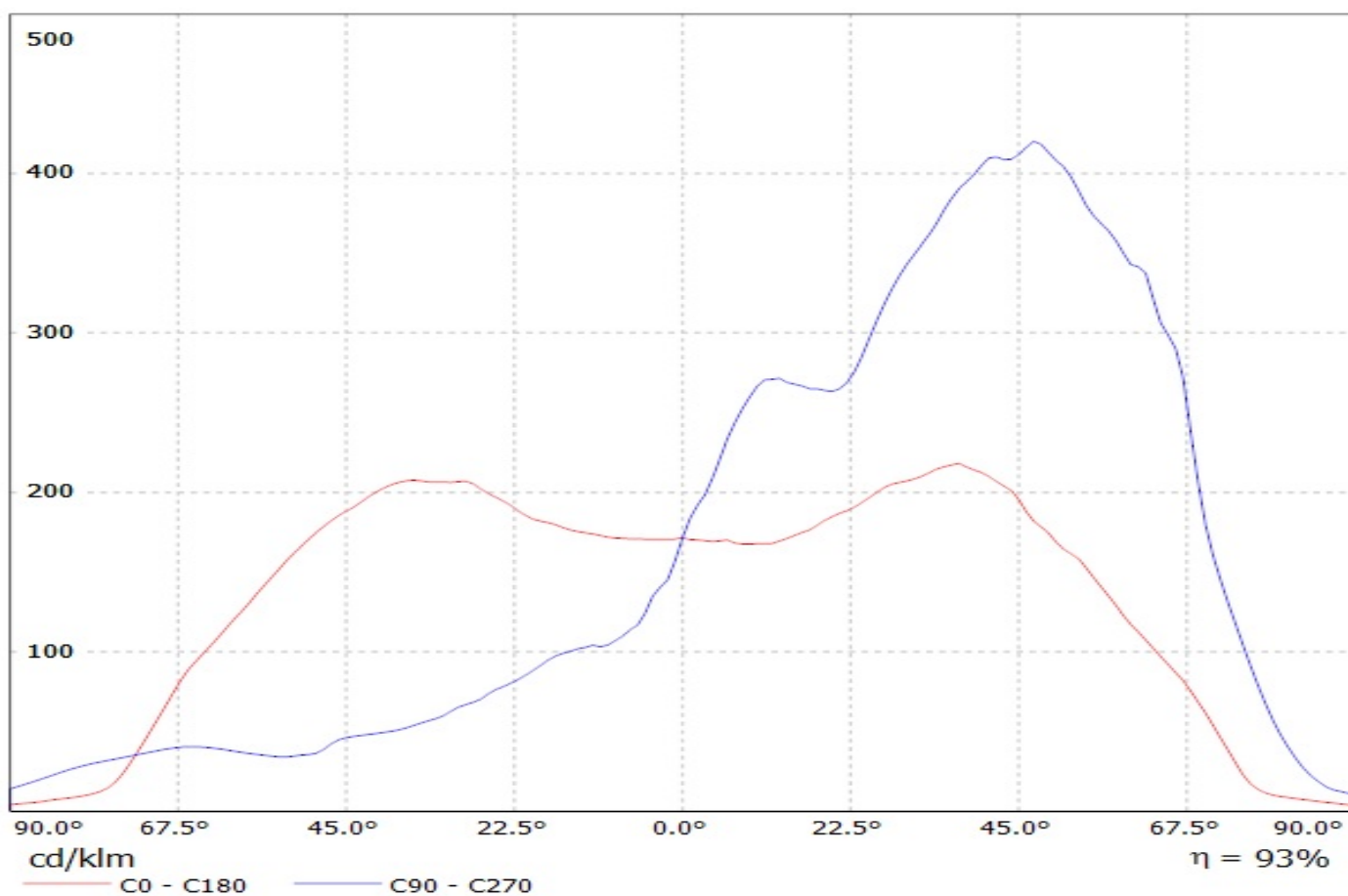

Luminaire: LEDiL Oy FN14645_STELLA-T4_(Soleriq_S19)

Lamps: 1 x Osram_Soleriq_S19_(GW_KAHJB1.EM)_1411.38lm@250mA_CCT=4372K_P=10.4361W_I=0.2498A

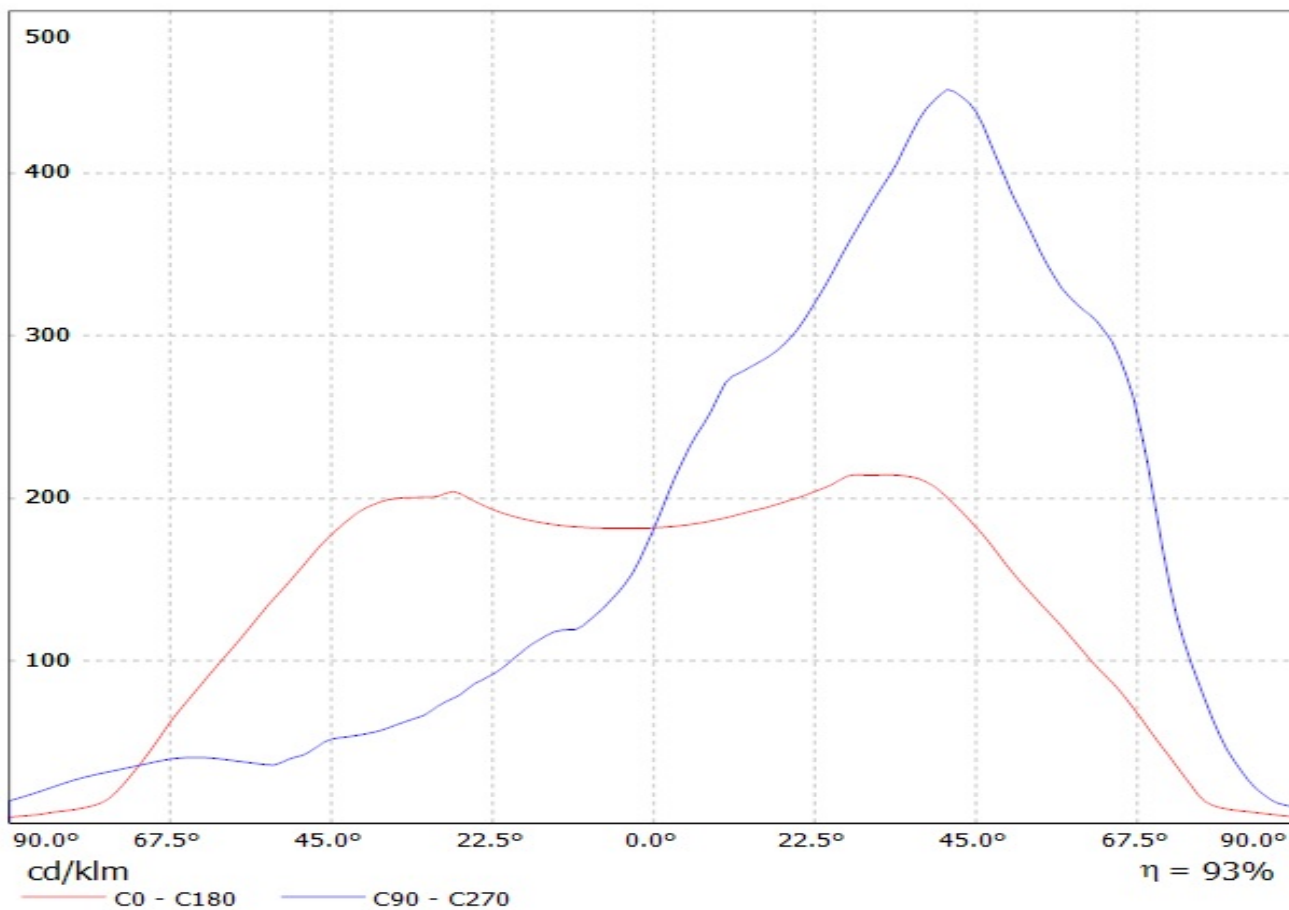

Luminaire: Ledil FN14645_STELLA-T4_(MJT_80W_Les22)_+431TypZ1

Lamps: 1 x Seoul_MJT_80W_Les22mm_(SAWx22AAA)_+431TypZ1_2501.46lm@250mA_P=13.317W_η=0.25A

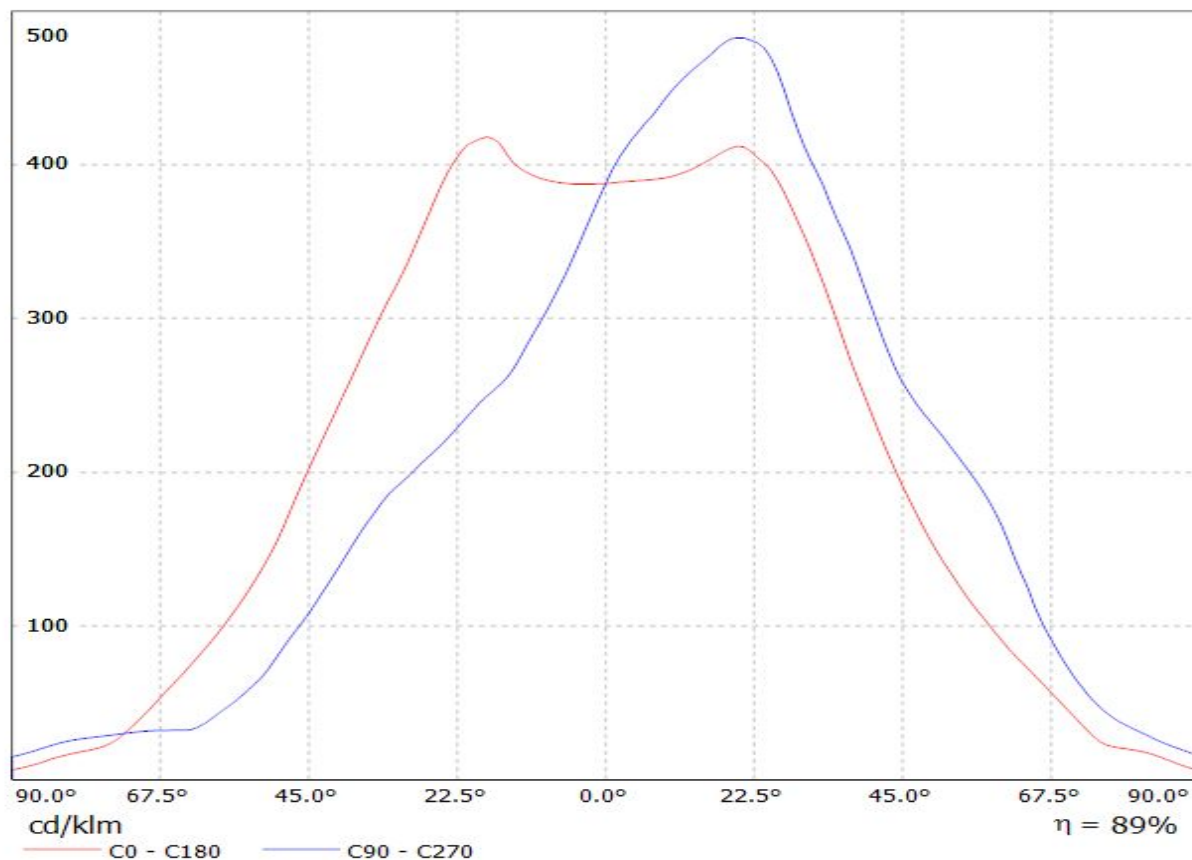

Luminaire: Ledil FN14645_STELLA-T4_(MJT_30W_Les14,5)_+433_Typ_Z1
Lamps: 1 x Seoul_MJT_30W_Les14,5mm_(SAWx1566A)_433_Typ_Z1_1343.97lm@250mA_P=8.2295W_I=0.25A

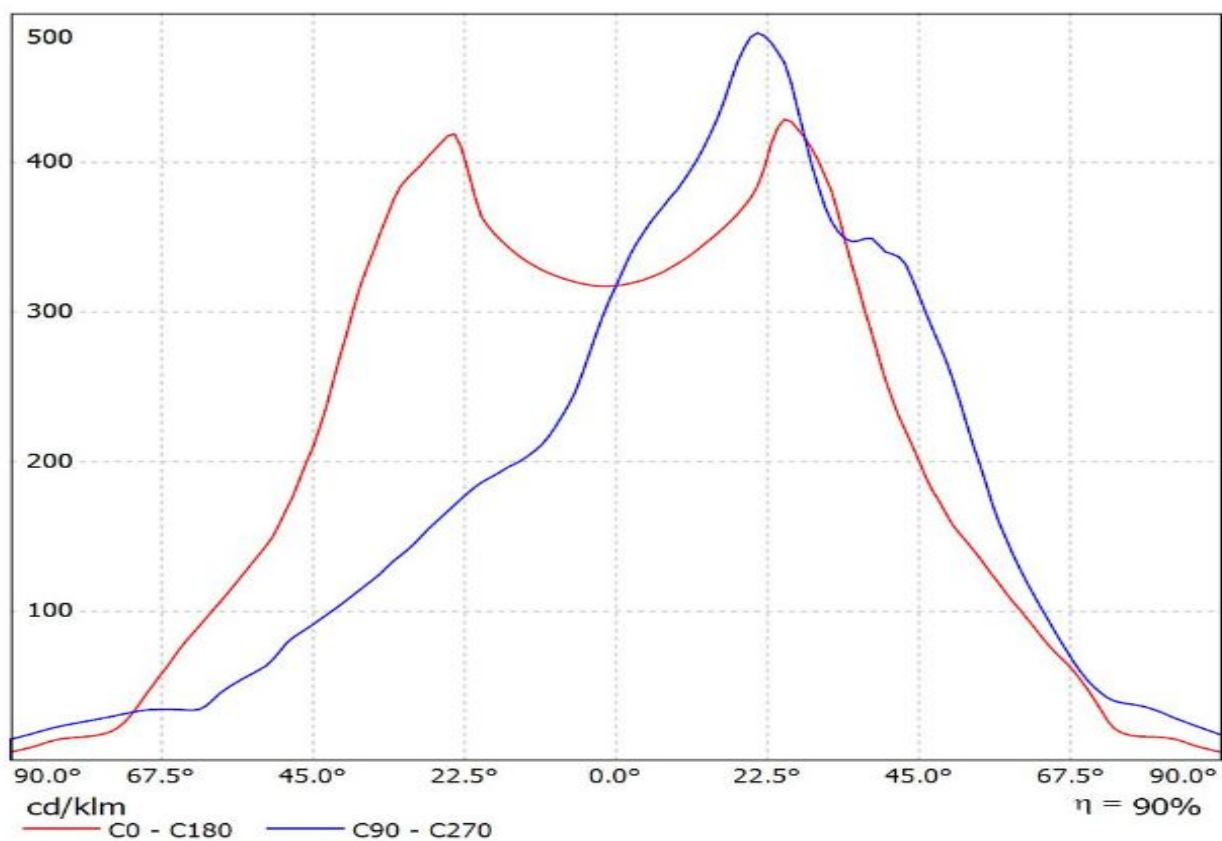

Luminaire: LEDiL Oy FN14645_STELLA-T4_(SLE-G5_LES-15)
Lamps: 1 x Tridonic_SLE-G5_LES-15_1280.24lm@250mA_P=8.6273W_I=0.250A

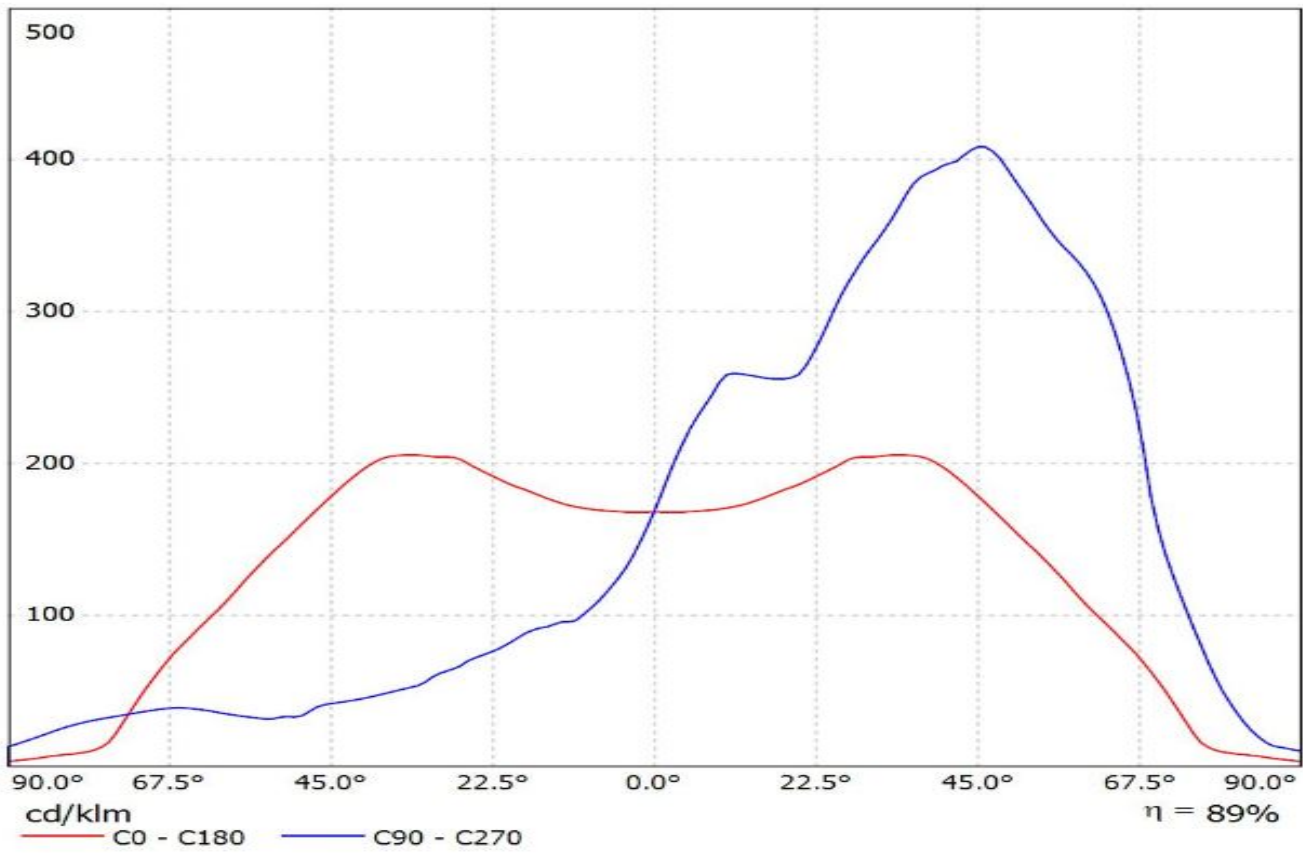

Luminaire: Ledil Oy FN14645_STELLA-T4+_Bender+Wirth 434 Typ Z1_BRIDGELUX_V10_Gen7_SIMULATED
Lamps: 1 x BRIDGELUX V10 Gen7

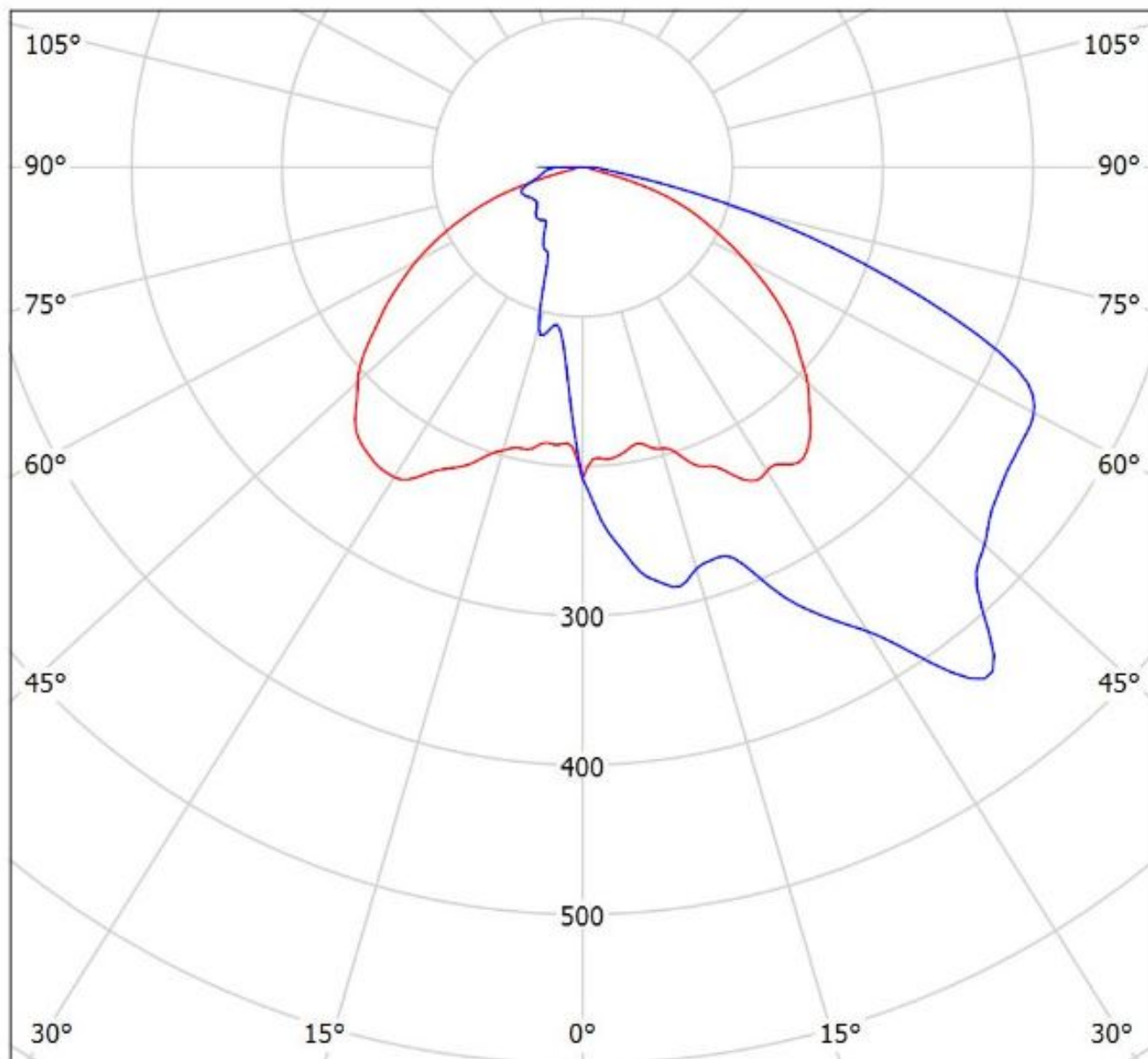

cd/klm

— C0 - C180 — C90 - C270

$\eta = 94\%$

Luminaire: Ledil Oy FN14645_STELLA-T4_Bridgelux_V22_Gen7_SIMULATED FN14645_STELLA-T4_Bridgelux_V22_Gen7_SIMULATED
Lamps: 1 x FN14645_STELLA-T4_Bridgelux_V22_Gen7_SIMULATED

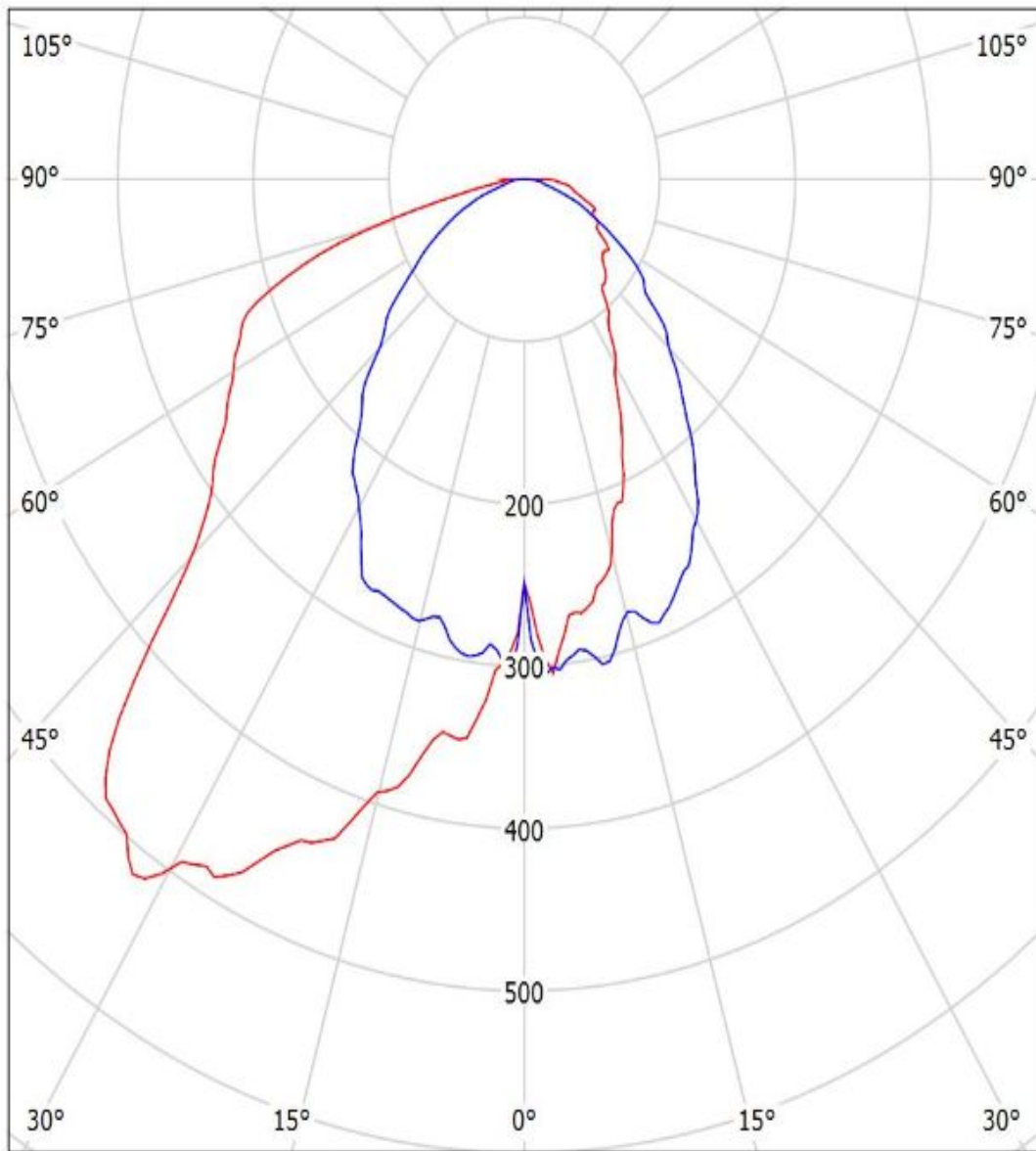

cd/klm

— C0 - C180 — C90 - C270

$\eta = 94\%$

Luminaire: Ledil Oy FN14645_STELLA-T4_BRIDGELUX_V18_Gen7_SIMULATED
Lamps: 1 x BRIDGELUX V10 Gen7

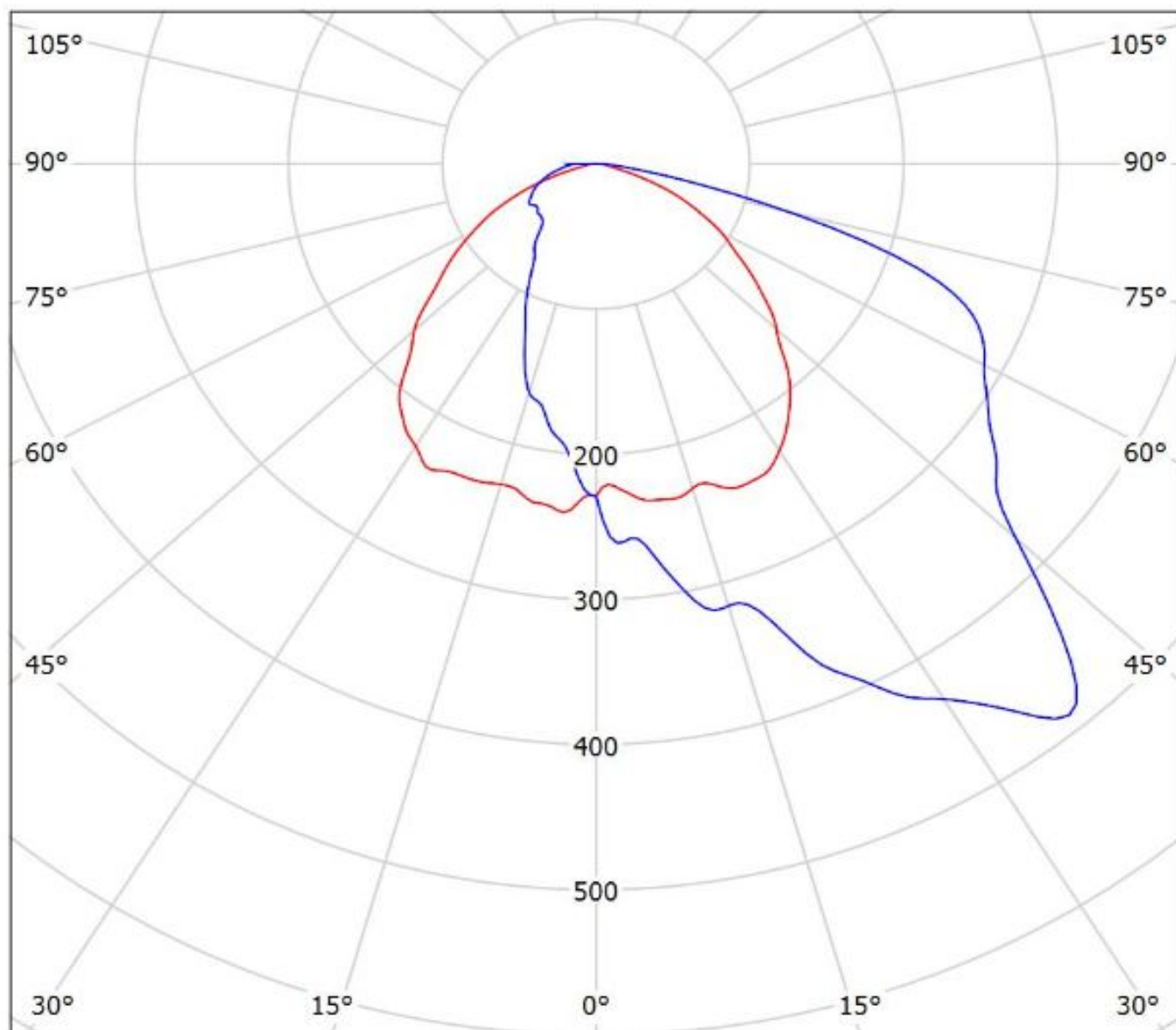

cd/klm

— C0 - C180 — C90 - C270

$\eta = 91\%$

Luminaire: LEDiL Oy FN14645_STELLA-T4_(CLU046)

Lamps: 1 x Citizen_CLU046_1354.66lm@250mA_P=8.06877W_I=0.2499A

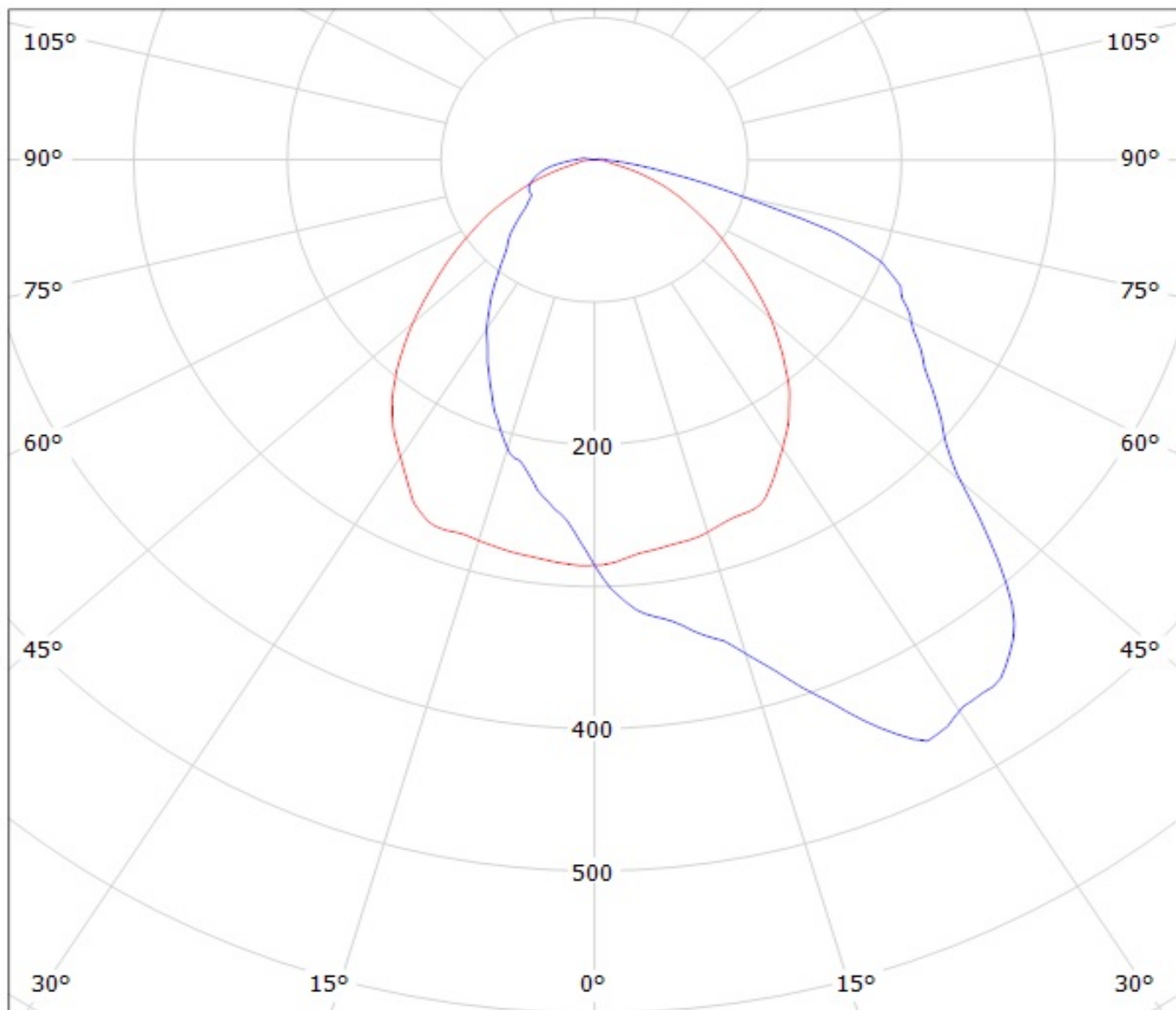

cd/klm

— C0 - C180

— C90 - C270

$\eta = 91\%$

Luminaire: Ledil Oy FN14645_STELLA-T4_(CLU048)_(B&W_431_Type_Z1)_SIMULATED
Lamps: 1 x Citizen CLU048-1818C4-303M2K1 + Bender & Wlrth 431 Type Z1

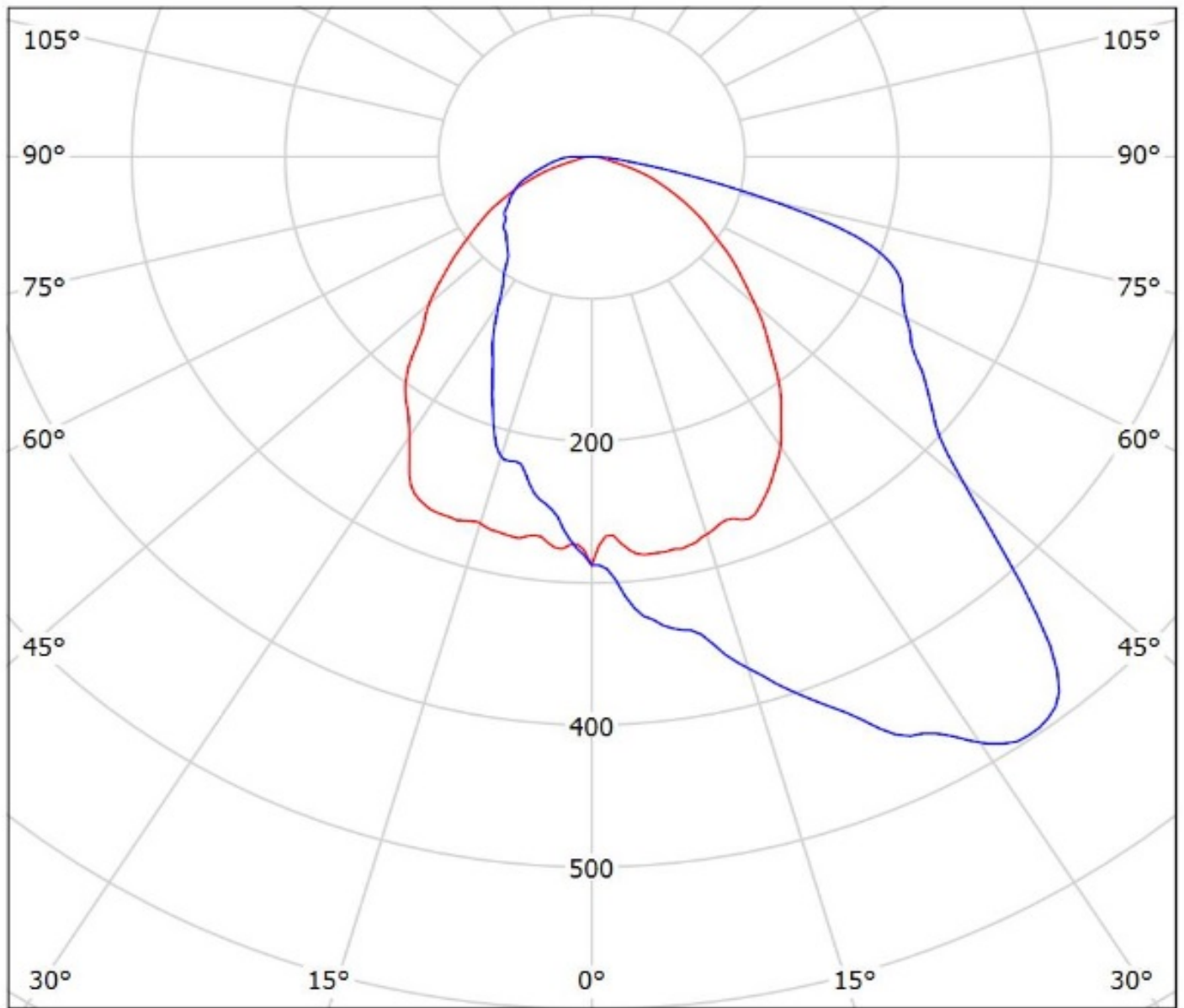

cd/klm

— C0 - C180 — C90 - C270

$\eta = 91\%$

Ledil FN14645_STELLA-T4_(COB1211) / LDC (Polar)

Luminaire: Ledil FN14645_STELLA-T4_(COB1211)

Lamps: 1 x LUXEON_COB1211_(LHC1-2790-1211)_955.193lm@250mA_CCT=2700K_P=8W_I=0.25A

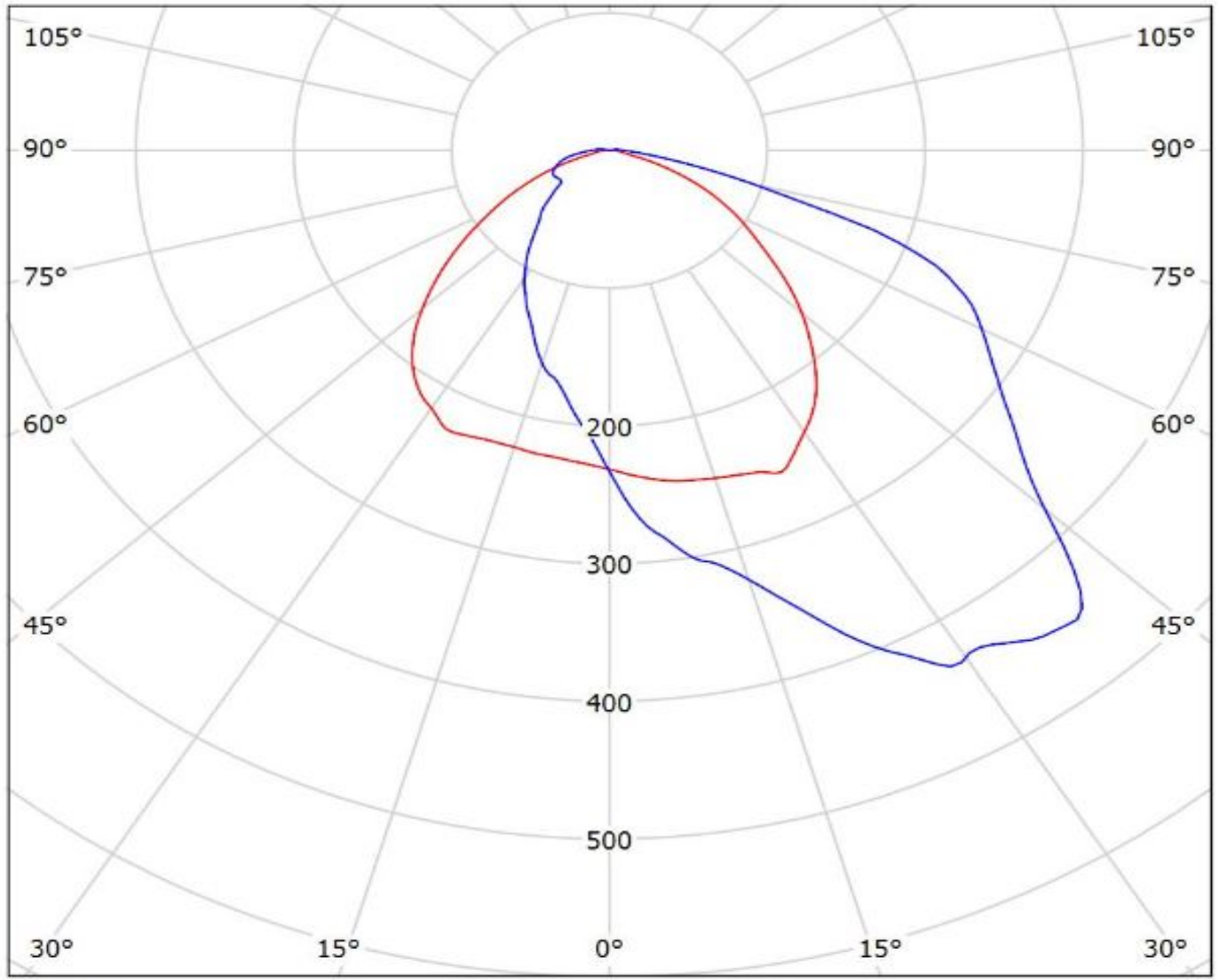

cd/klm

— C0 - C180

— C90 - C270

$\eta = 92\%$

Ledil FN14645_STELLA-T4_(COB1208) / LDC (Polar)

Luminaire: Ledil FN14645_STELLA-T4_(COB1208)

Lamps: 1 x LUXEON_COB1208_(LHC1-3090-1208)_1100.7lm@250mA_CCT=3215K_P=8.3W_I=0.25A

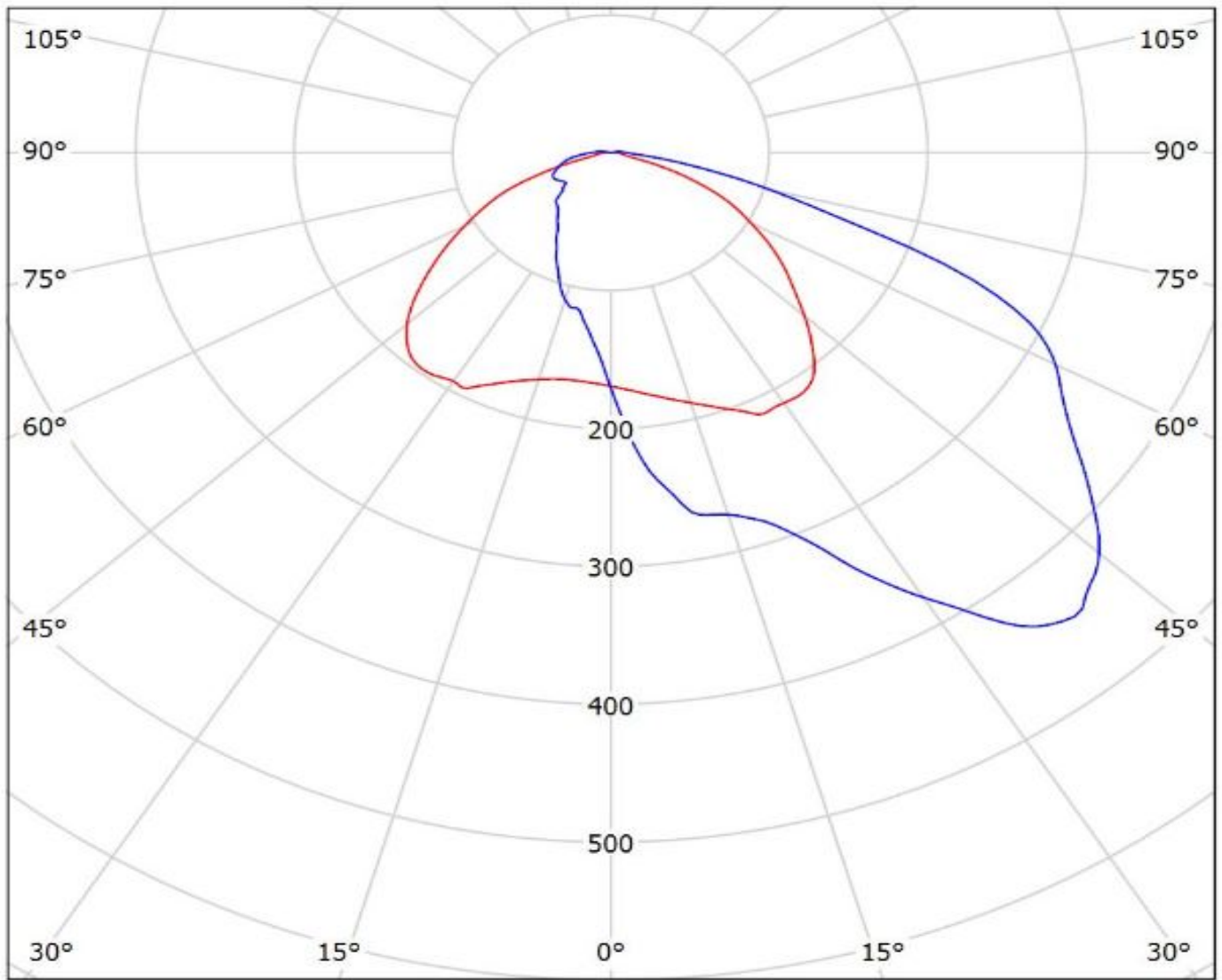

cd/klm

— C0 - C180 — C90 - C270

$\eta = 93\%$

Luminaire: Ledil FN14645_STELLA-T4_(CoB_1216)

Lamps: 1 x Luxeon_CoB_1216_(L2C2-40801216E2300)_1468.12lm@250mA_P=7.9868W_I=0.25A

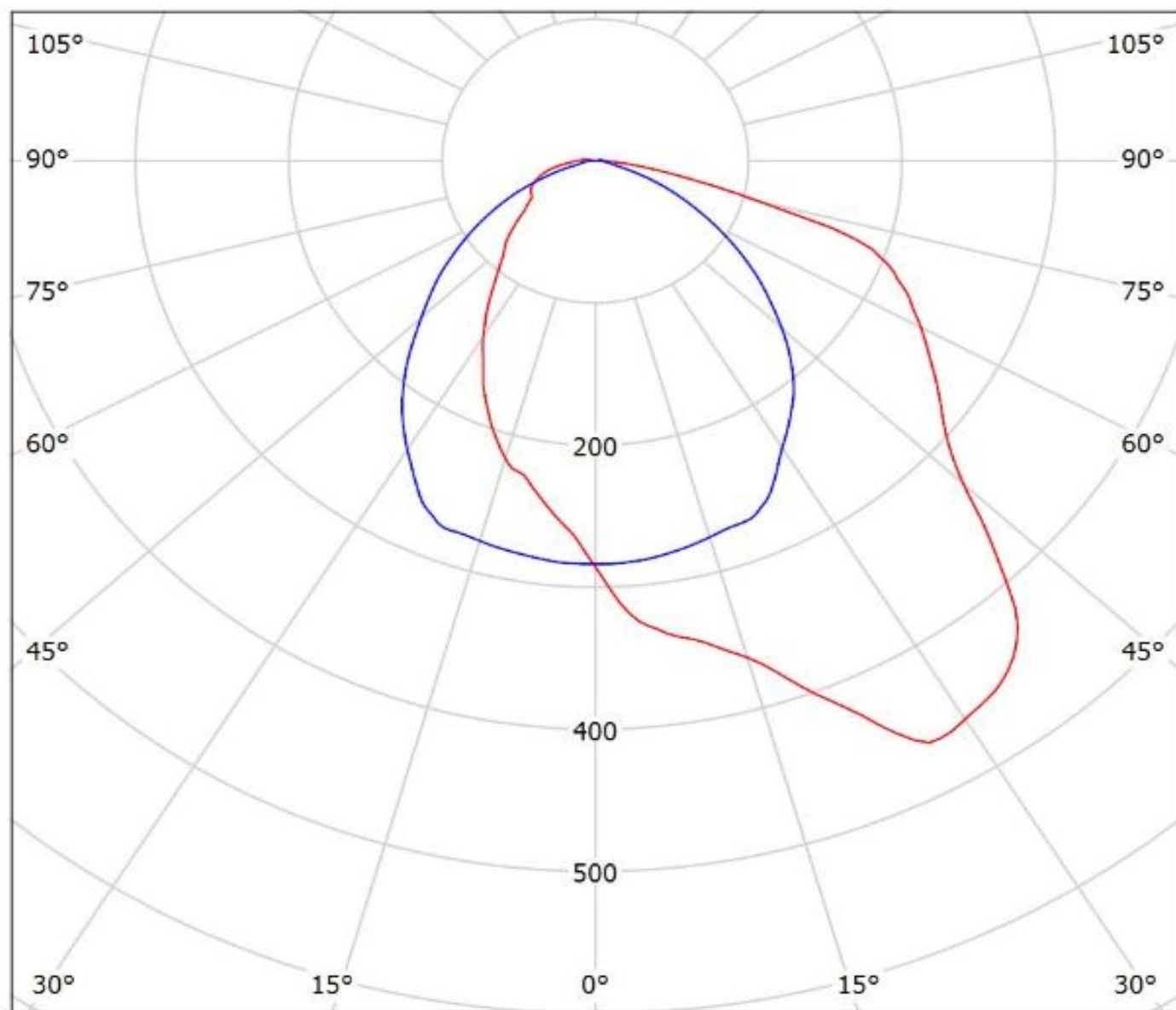

cd/klm

— C0 - C180 — C90 - C270

$\eta = 92\%$

Luminaire: Ledil FN14645_STELLA-T4_(CXM-14)

Lamps: 1 x Luminus_XNOVA-CXM-14_1156.79lm@250mA_U=8.3W_I=0.25A

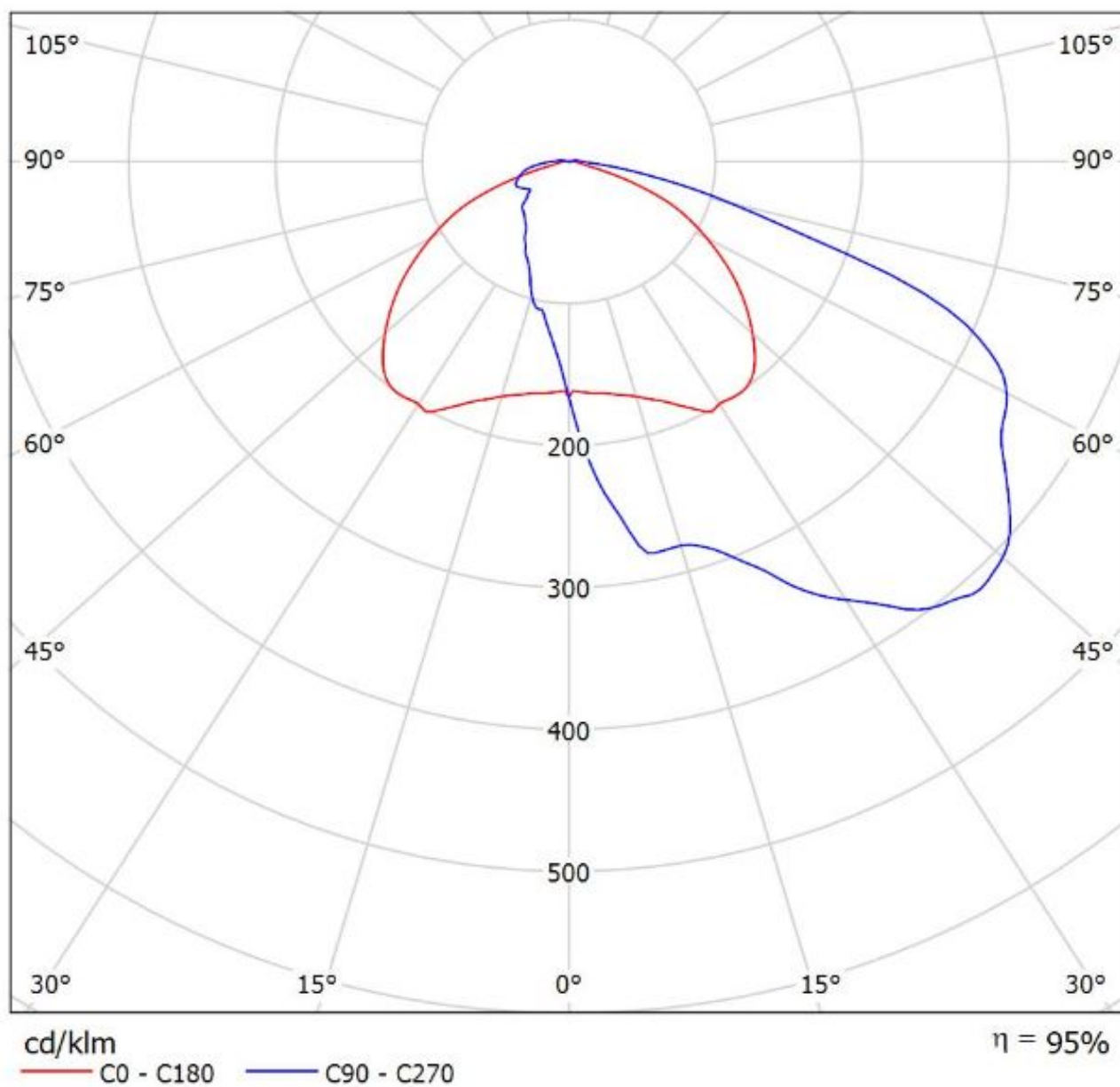

Luminaire: Ledil FN14645_STELLA-T4_(CXM-18)

Lamps: 1 x Luminus_XNOVA-CXM-18_921.635lm@250mA_U=8.12W_I=0.25A

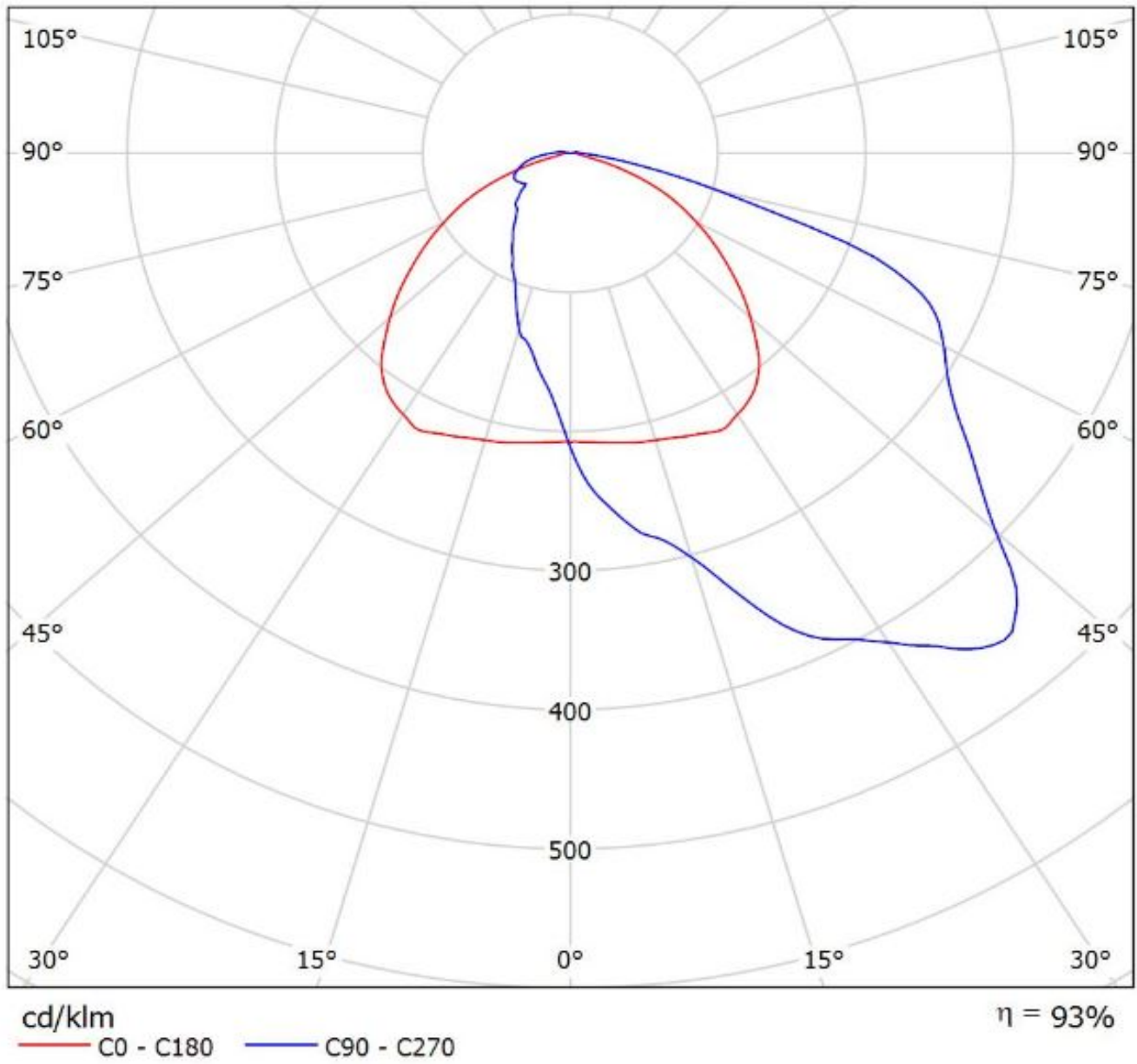

Luminaire: Ledil Oy FN14645_STELLA-T4_(CXM-22)_(B&W_431_Type_Z1)_SIMULATED
Lamps: 1 x Luminus CXM-22 + Bender & Wirth 431 Type Z1

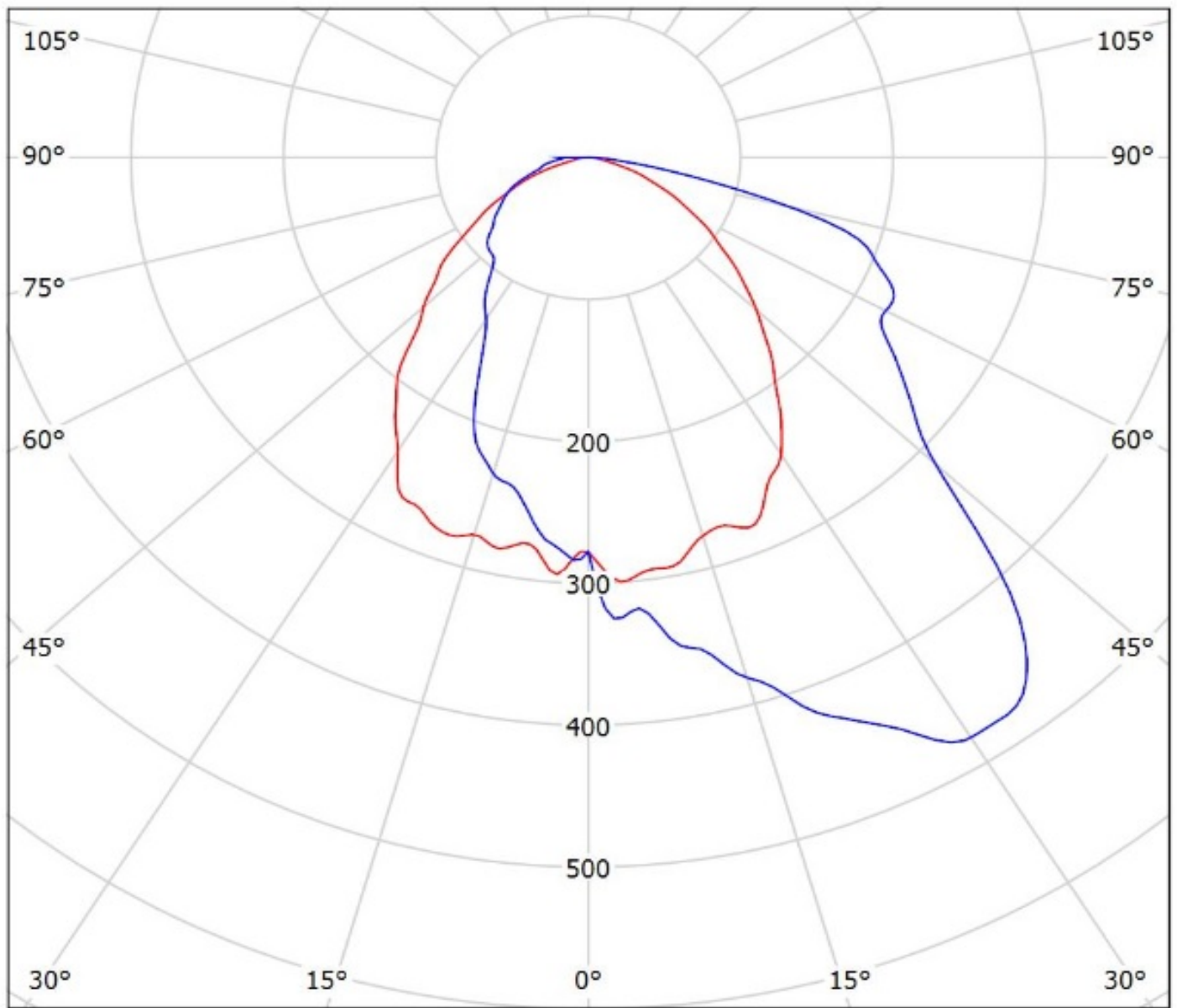

cd/klm

— C0 - C180 — C90 - C270

$\eta = 91\%$

Luminaire: LEDiL Oy FN14645_STELLA-T4_(Soleriq_P9)

Lamps: 1 x Osram_Soleriq_P9_(GW_MAFJB1.EM)_883.856lm@250mA_CCT=4372K_P=6.86301W_I=0.2498A

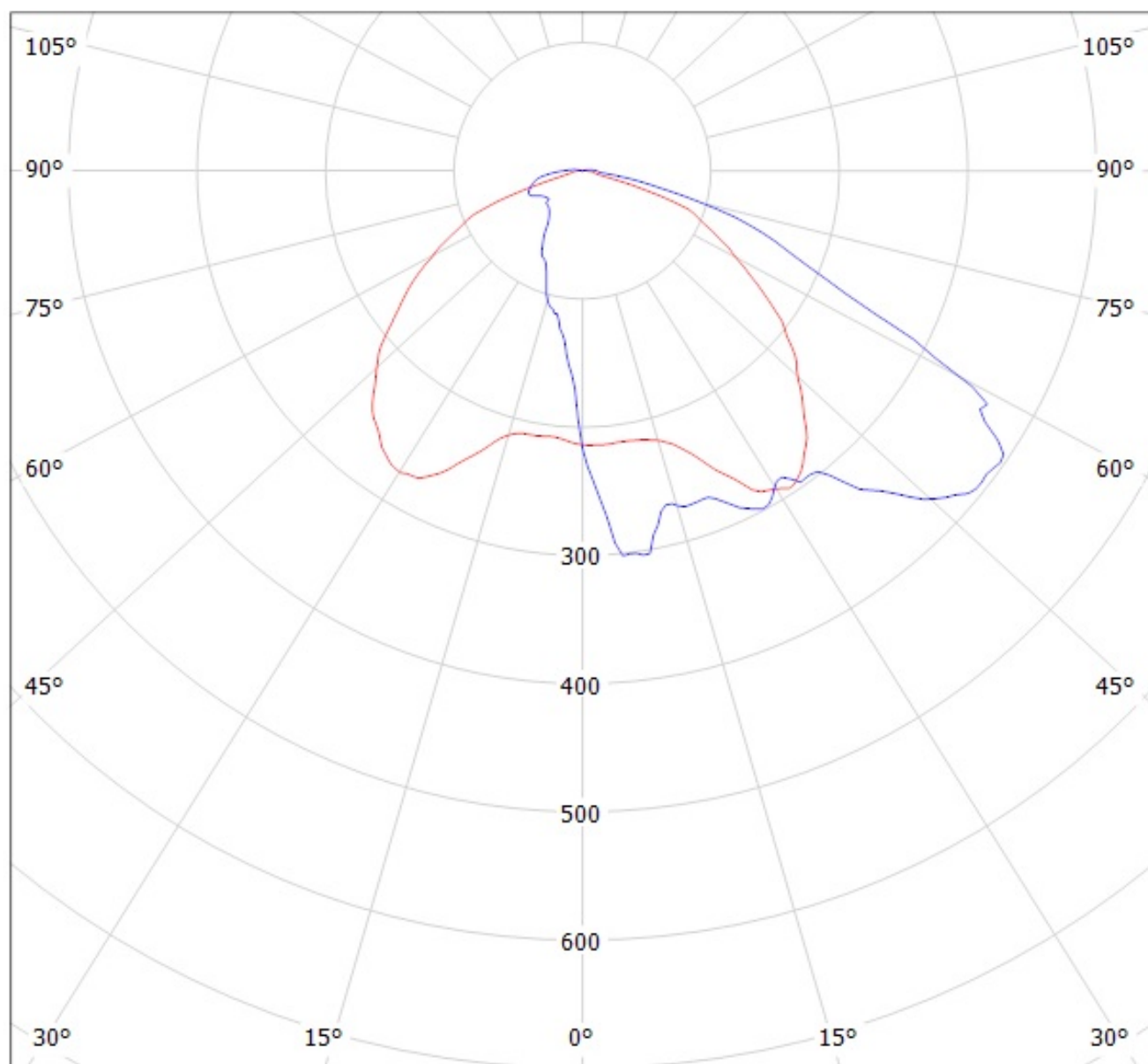

cd/klm

— C0 - C180

— C90 - C270

$\eta = 94\%$

Luminaire: LEDiL Oy FN14645_STELLA-T4_(Soleriq_S13)

Lamps: 1 x Osram_Soleriq_S13_(GW_KAGHB1.EM)_867.588lm@250mA_P=7.35456W_I=0.2499A

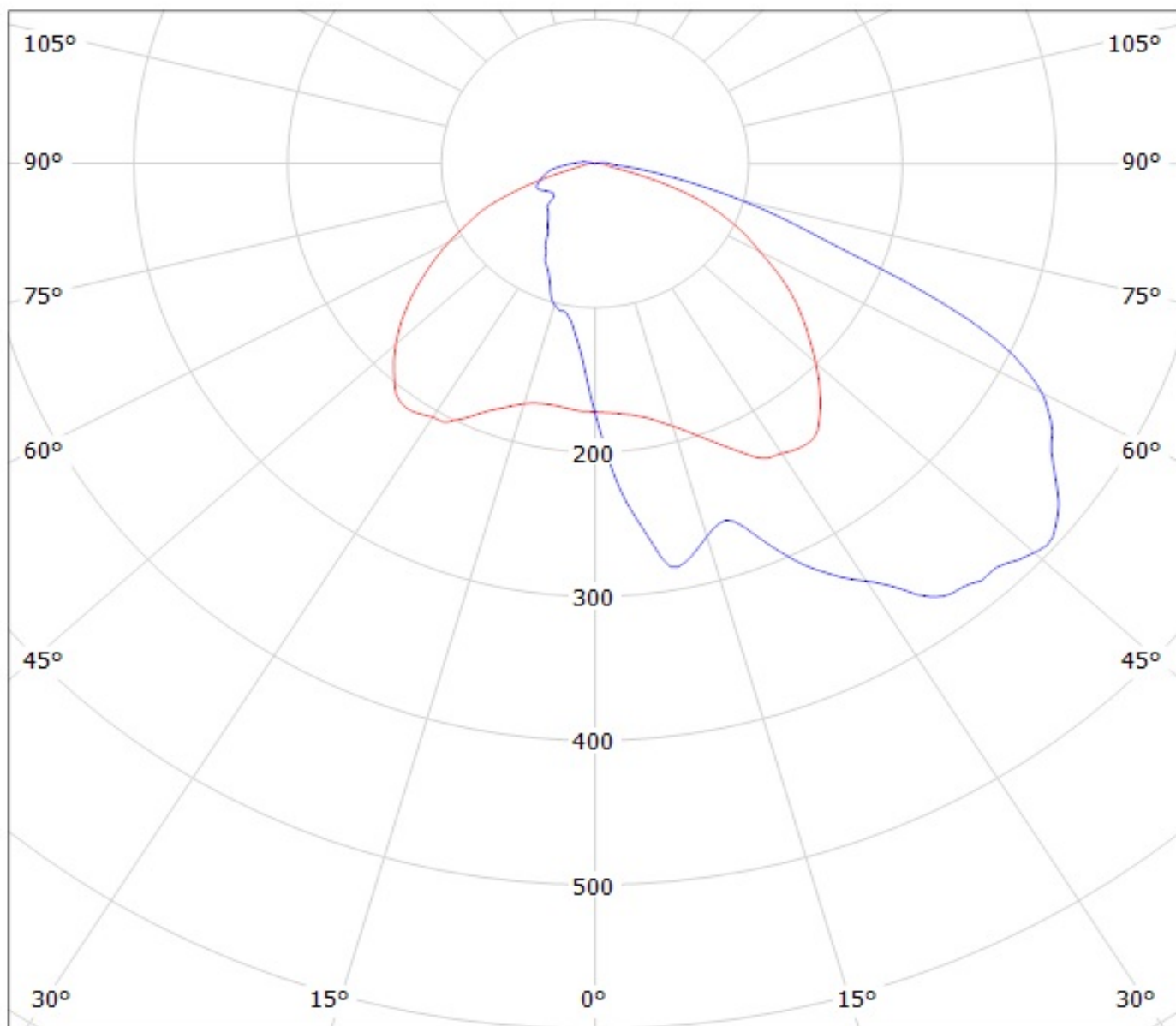

cd/klm

— C0 - C180

— C90 - C270

$\eta = 93\%$

Luminaire: LEDiL Oy FN14645_STELLA-T4_(Soleriq_P13)

Lamps: 1 x Osram_Soleriq_P13_(GW_MAGMB1.EM)_935.757lm@250mA_P=8.73875W_I=0.2498A

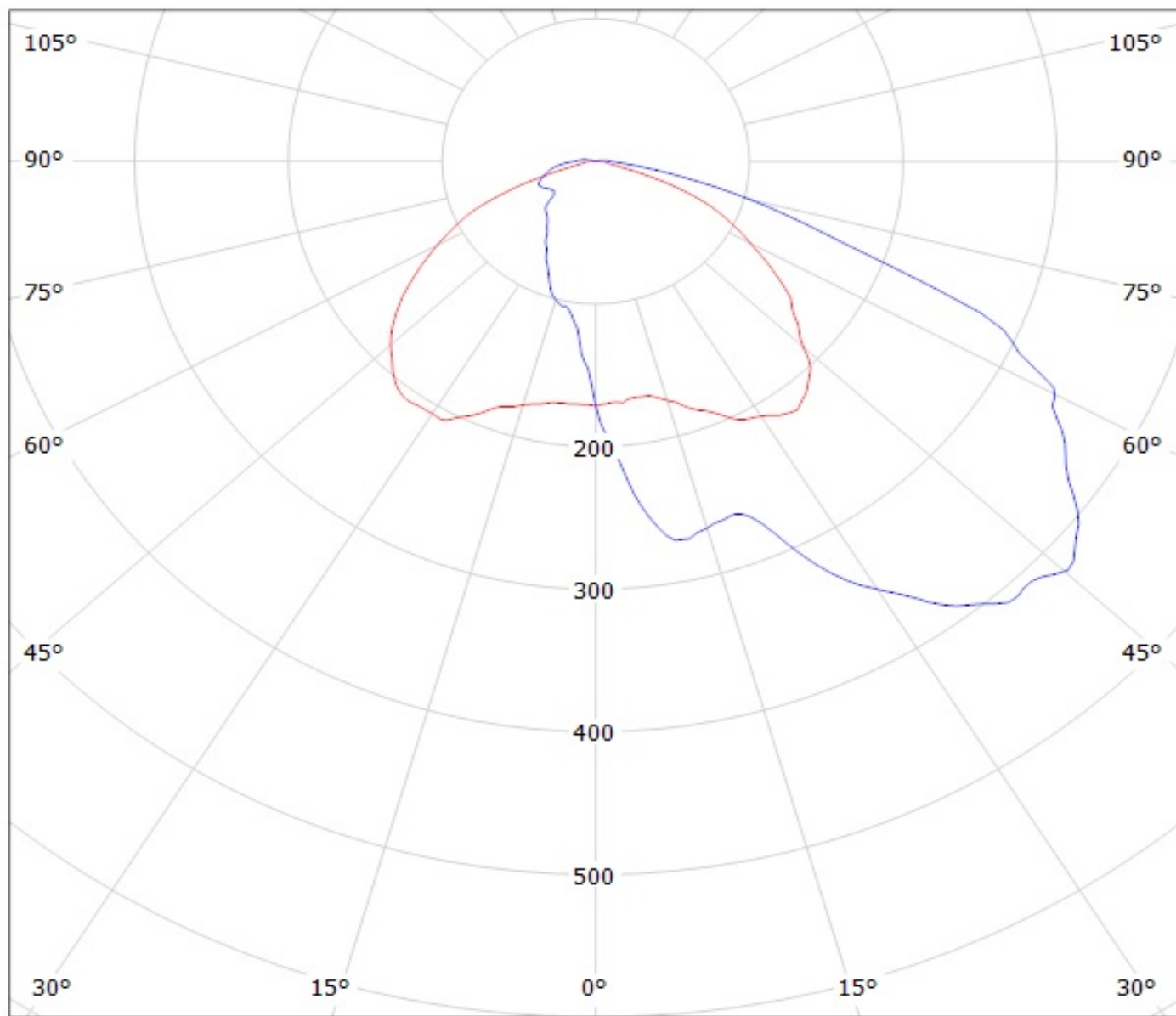

cd/klm

$\eta = 93\%$

— C0 - C180

— C90 - C270

Luminaire: LEDiL Oy FN14645_STELLA-T4_(Soleriq_S19)

Lamps: 1 x Osram_Soleriq_S19_(GW_KAHJB1.EM)_1411.38lm@250mA_CCT=4372K_P=10.4361W_I=0.2498A

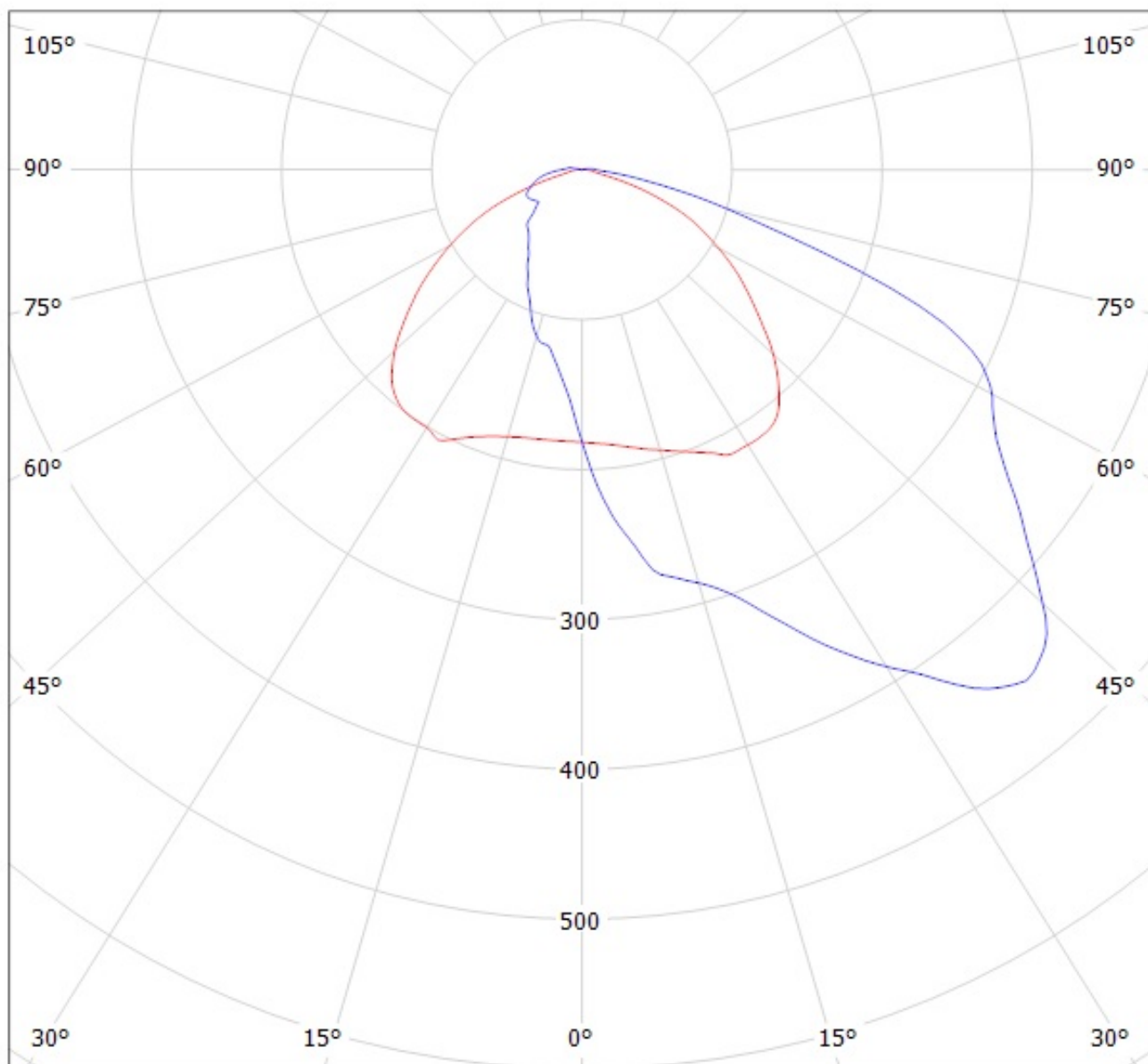

cd/klm

— C0 - C180

— C90 - C270

$\eta = 93\%$

Luminaire: Ledil FN14645_STELLA-T4_(MJT_80W_Les22)_+431TypZ1

Lamps: 1 x Seoul_MJT_80W_Les22mm_(SAWx22AAA)_+431TypZ1_2501.46lm@250mA_P=13.317W_I=0.25A

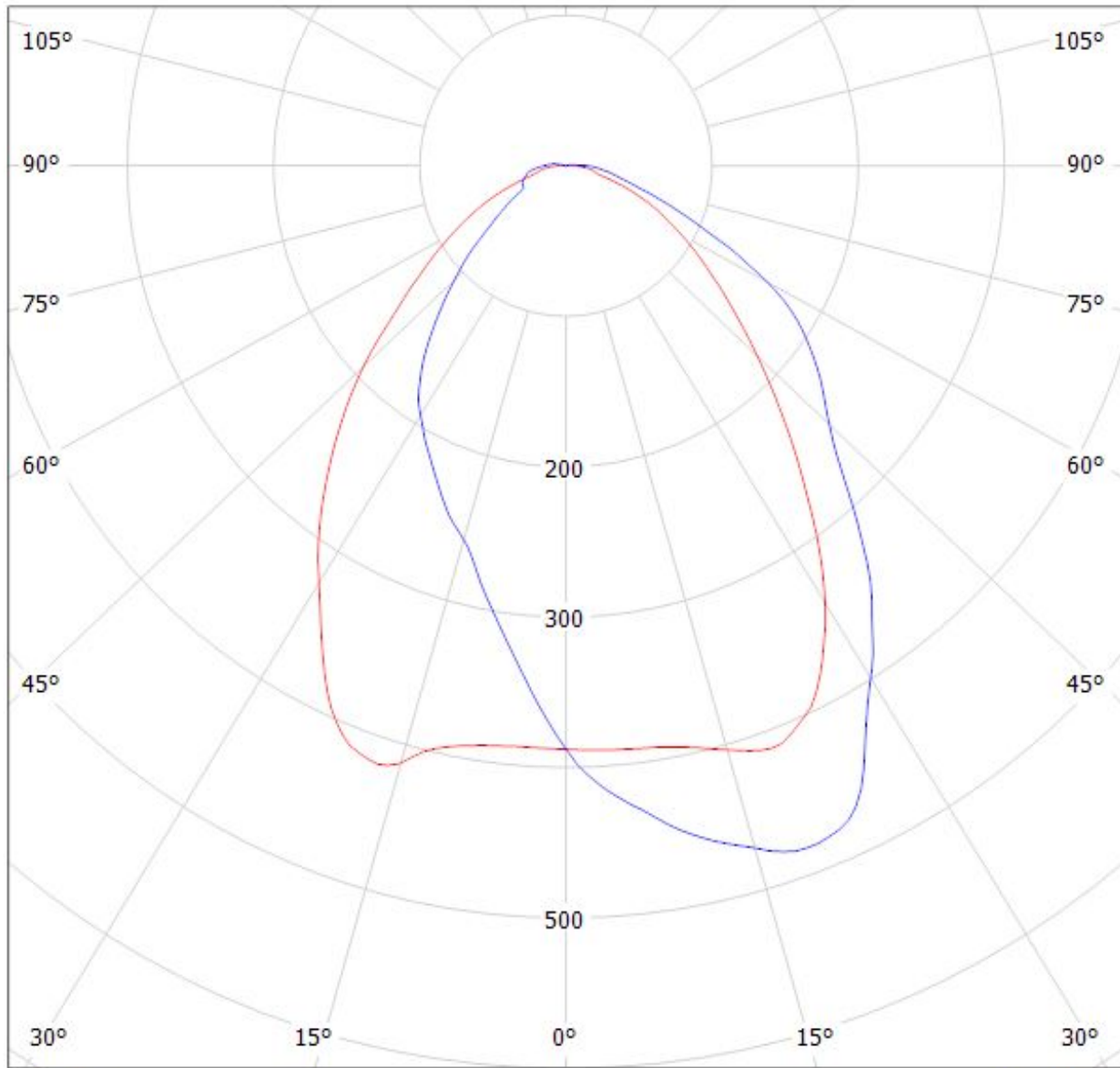

cd/klm

η = 89%

— C0 - C180

— C90 - C270

Luminaire: Ledil FN14645_STELLA-T4_(MJT_30W_Les14,5)_+433_Typ_Z1

Lamps: 1 x Seoul_MJT_30W_Les14,5mm_(SAWx1566A)_433_Typ_Z1_1343.97lm@250mA_P=8.2295W_I=0.25A

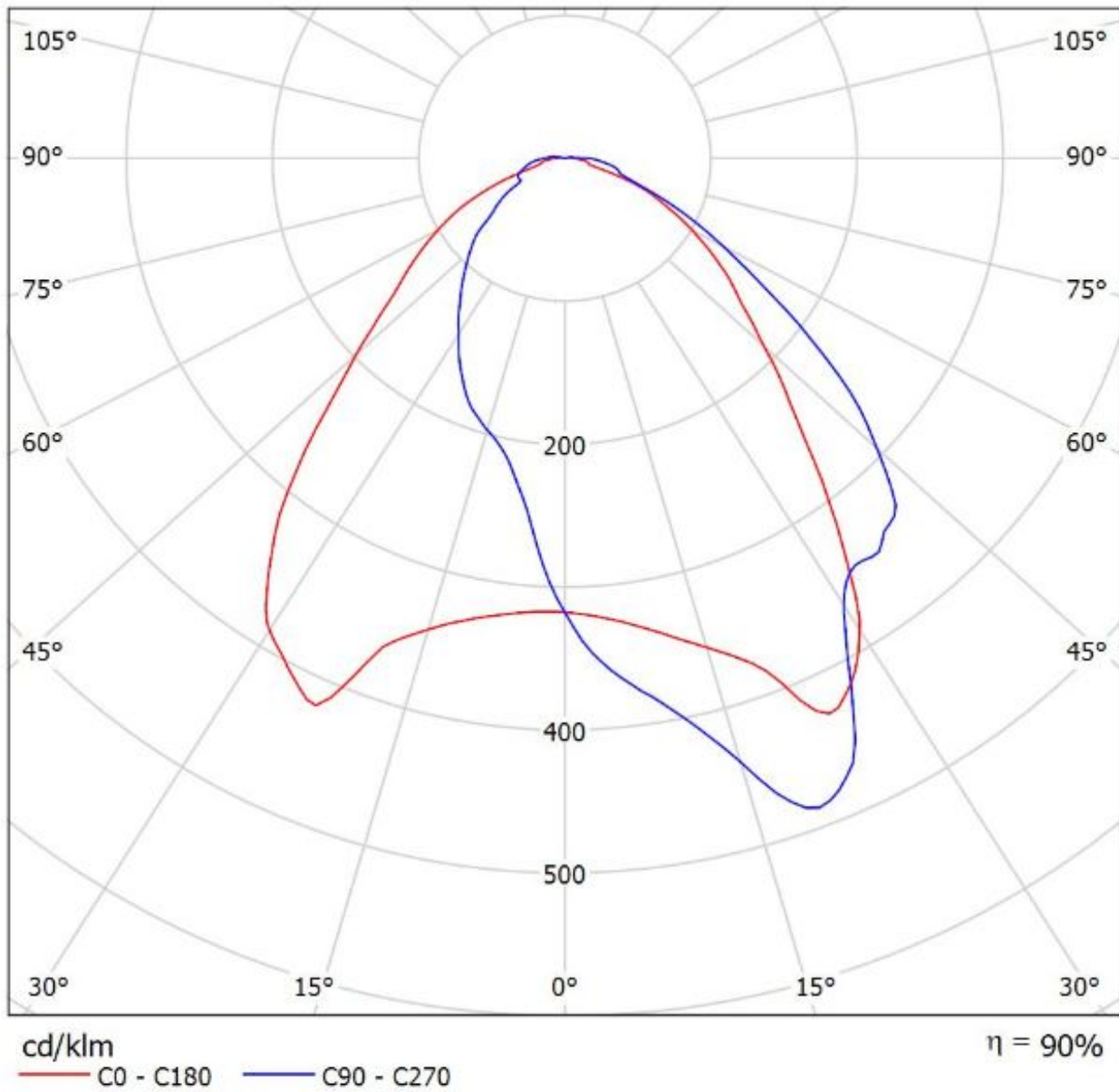

Luminaire: LEDiL Oy FN14645_STELLA-T4_(SLE-G5_LES-15)

Lamps: 1 x Tridonic_SLE-G5_LES-15_1280.24lm@250mA_P=8.6273W_I=0.250A

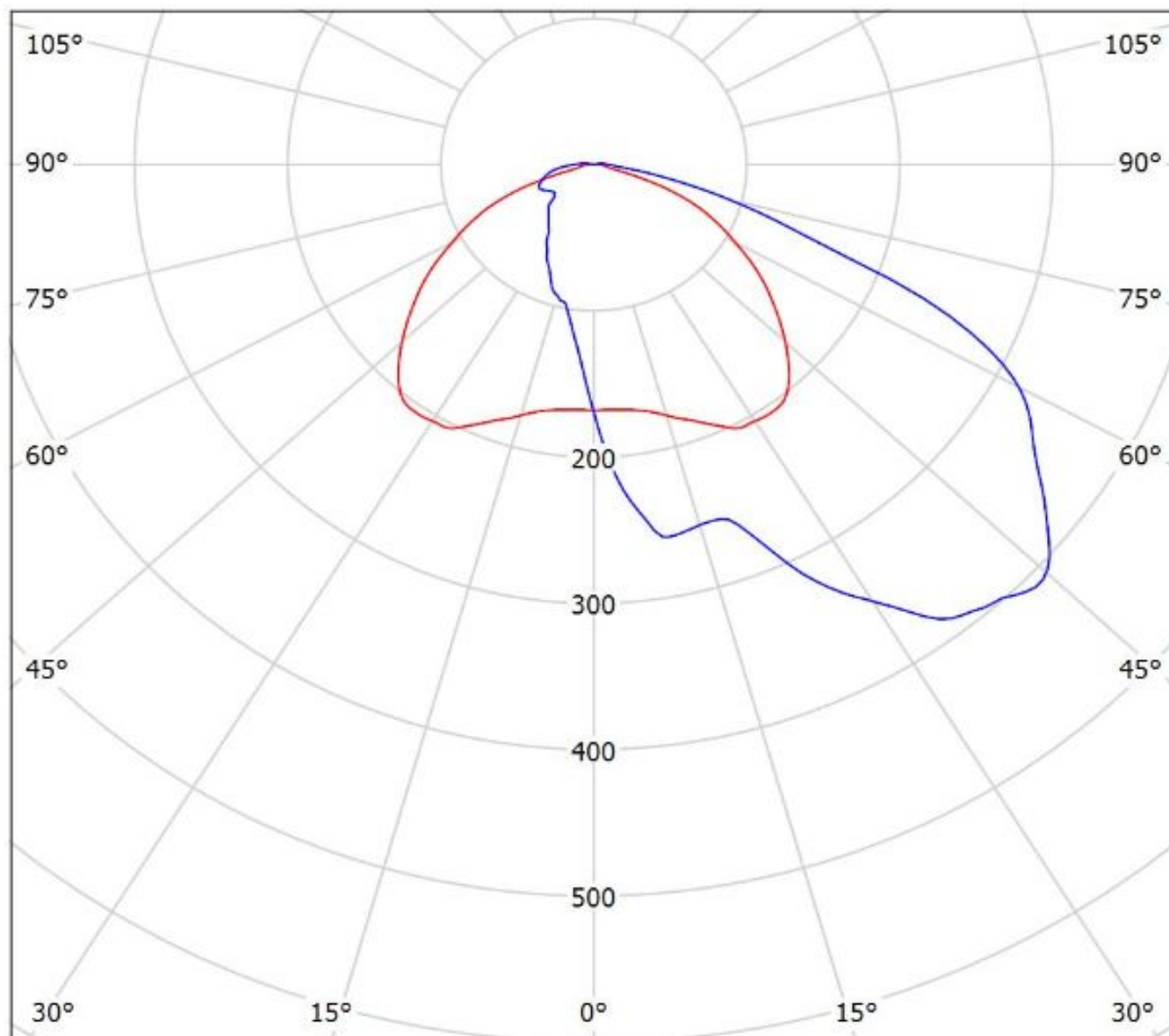

cd/klm

— C0 - C180

— C90 - C270

$\eta = 89\%$

NOTE: The typical divergence will be changed by different color, chip size and chip position tolerance. The typical total divergence is the full angle measured where the luminous intensity is half of the peak value.

GENERAL INFORMATION

- Product series especially designed & optimized for series of LEDs.
- Special care taken to make light distribution as uniform as possible.

Note! Due to use of high power COB's with this product, special attention to proper thermal design is highly recommended. LEDiL has no liability for direct, indirect or consecutive damages arising from the LEDiL products being used outside of the recommended temperature range.