

Typical Applications

The HMC516LC5 is ideal for use as a LNA or driver amplifier for:

- Point-to-Point Radios
- Point-to-Multi-Point Radios & VSAT
- Test Equipment and Sensors
- Military

Features

- Noise Figure: 2 dB
- Gain: 20 dB
- OIP3: +25 dBm
- Single Supply: +3V @ 65 mA
- 50 Ohm Matched Input/Output
- RoHS Compliant 5x5 mm Package

Functional Diagram

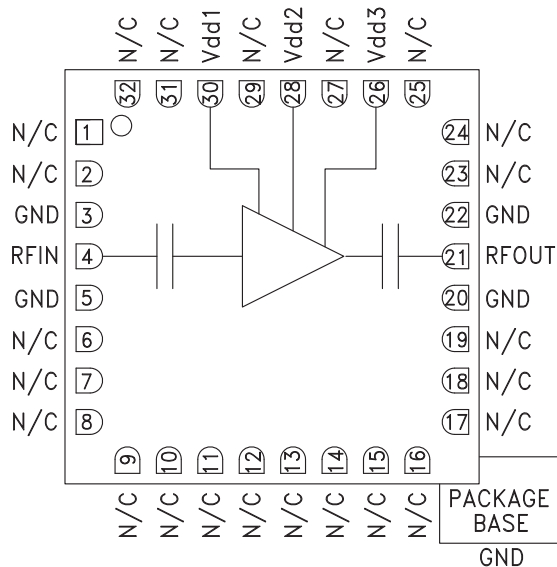

General Description

The HMC516LC5 is a high dynamic range GaAs PHEMT MMIC Low Noise Amplifier (LNA) housed in a leadless "Pb free" RoHS compliant SMT package. The HMC516LC5 provides 20 dB of small signal gain, 2 dB of noise figure and has an output IP3 of +25 dBm. The P1dB output power of +13 dBm enables the LNA to also function as a LO driver for balanced, I/Q or image reject mixers. The HMC516LC5 allows the use of surface mount manufacturing techniques.

Electrical Specifications, $T_A = +25^\circ \text{C}$, Vdd 1, 2, 3 = +3V

Parameter	Min.	Typ.	Max.	Min.	Typ.	Max.	Units
Frequency Range	9 - 12		12 - 18				GHz
Gain	17.5	20		18	20.5		dB
Gain Variation Over Temperature		0.015	0.025		0.015	0.025	dB/°C
Noise Figure		2.0	2.5		2.0	2.5	dB
Input Return Loss		10			10		dB
Output Return Loss		12			12		dB
Output Power for 1 dB Compression (P1dB)		13			14		dBm
Saturated Output Power (P _{sat})		15			16		dBm
Output Third Order Intercept (IP3)		25			25		dBm
Supply Current (I _{dd})(V _{dd} = +3V)		65	88		65	88	mA

Broadband Gain & Return Loss

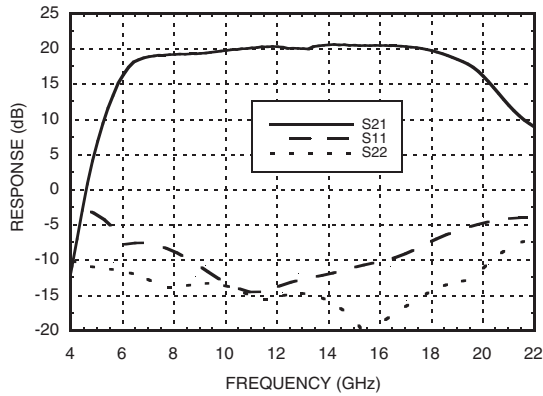

Gain vs. Temperature

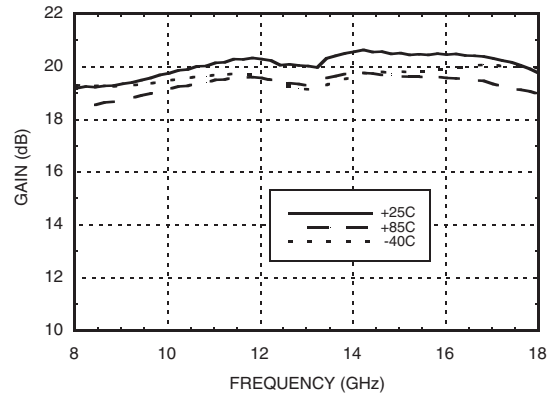

Input Return Loss vs. Temperature

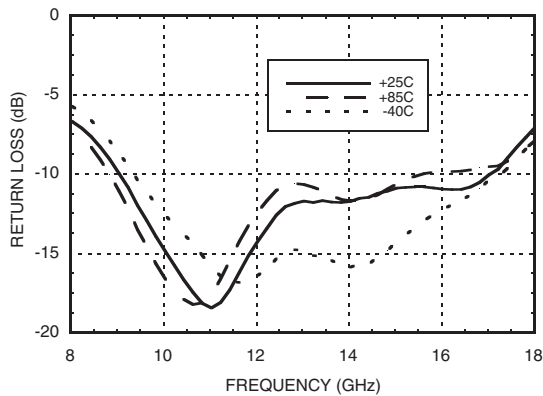

Output Return Loss vs. Temperature

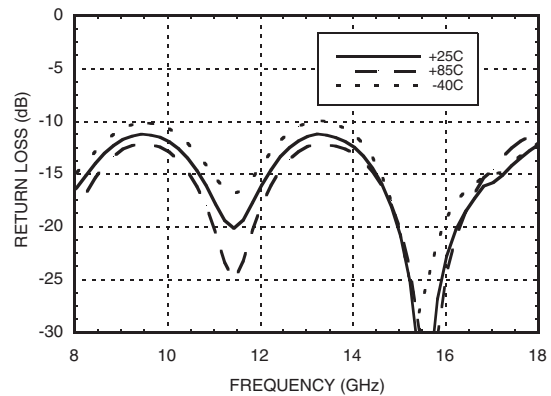

Noise Figure vs. Temperature

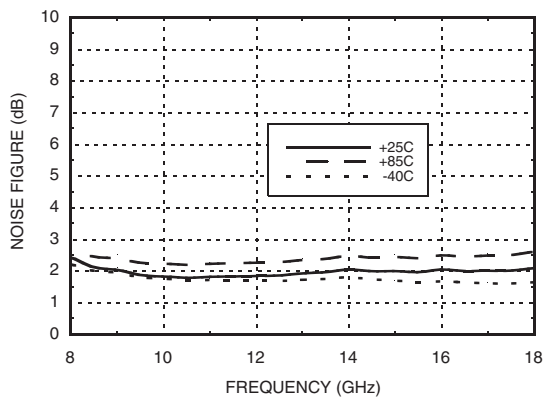

Output IP3 vs. Temperature

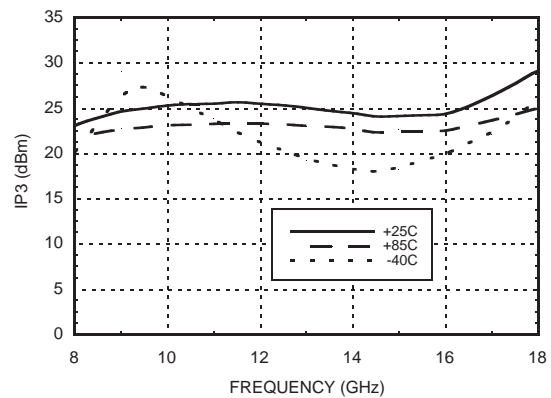

P1dB vs. Temperature

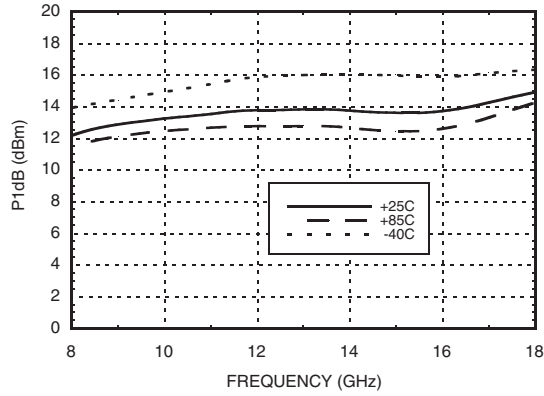

Psat vs. Temperature

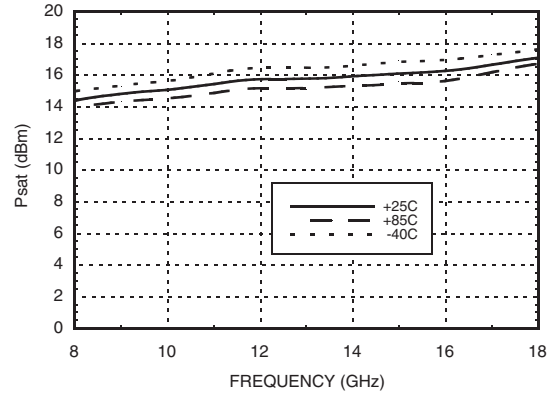

Reverse Isolation vs. Temperature

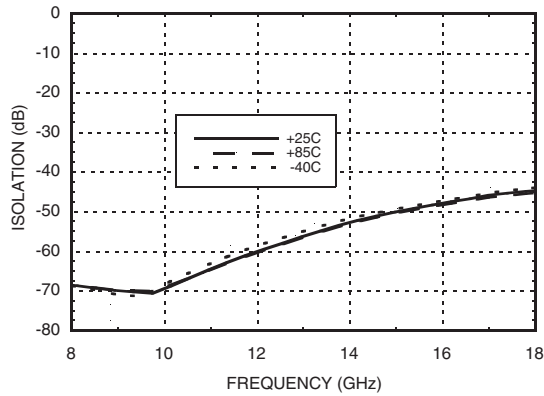

Power Compression @ 12 GHz

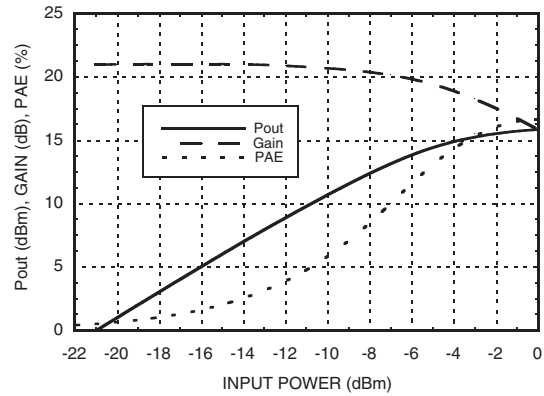

Gain, Noise Figure & Power vs. Supply Voltage @ 12 GHz

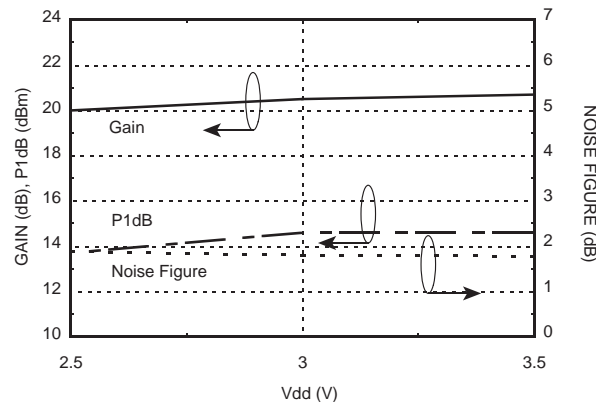

Absolute Maximum Ratings

Drain Bias Voltage (Vdd1, Vdd2, Vdd3)	+4 Vdc
RF Input Power (RFIN)(Vdd = +3.0 Vdc)	+5 dBm
Channel Temperature	175 °C
Continuous Pdiss (T= 85 °C) (derate 14 mW/°C above 85 °C)	1.25 W
Thermal Resistance (channel to die bottom)	71 °C/W
Storage Temperature	-65 to +150 °C
Operating Temperature	-40 to +85 °C
ESD Sensitivity (HBM)	Class 1A

Typical Supply Current vs. Vdd

Vdd (Vdc)	Idd (mA)
+2.5	61
+3.0	65
+3.5	69

Note: Amplifier will operate over full voltage range shown above.



ELECTROSTATIC SENSITIVE DEVICE
OBSERVE HANDLING PRECAUTIONS

Outline Drawing

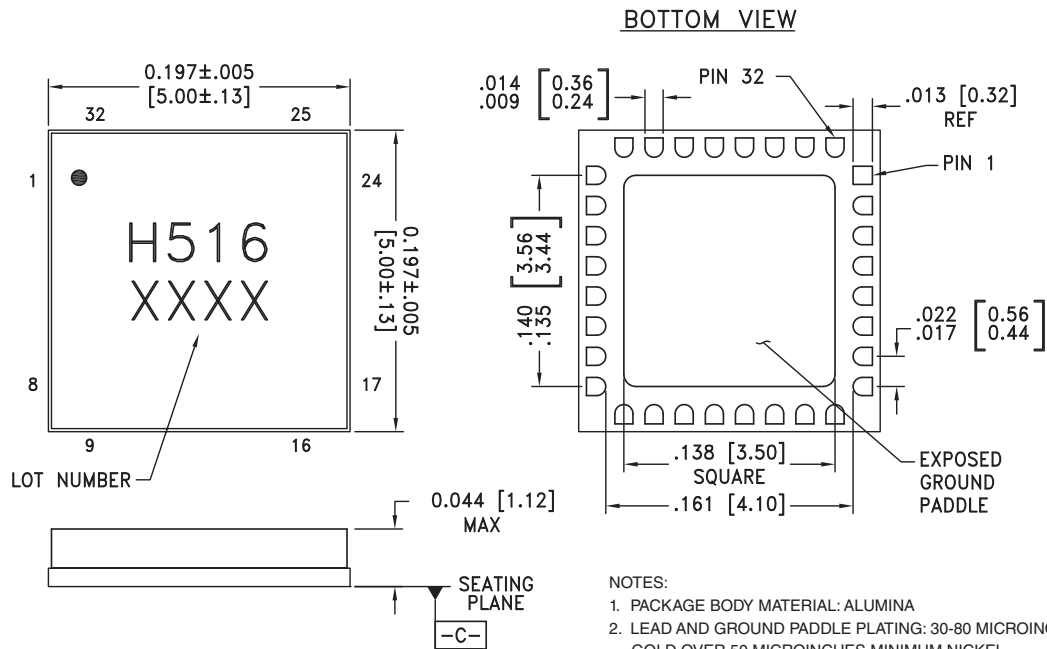

NOTES:

1. PACKAGE BODY MATERIAL: ALUMINA
2. LEAD AND GROUND PADDLE PLATING: 30-80 MICROINCHES GOLD OVER 50 MICROINCHES MINIMUM NICKEL
3. DIMENSIONS ARE IN INCHES [MILLIMETERS]
4. LEAD SPACING TOLERANCE IS NON-CUMULATIVE
5. PACKAGE WARP SHALL NOT EXCEED 0.05mm DATUM
6. ALL GROUND LEADS AND GROUND PADDLE MUST BE SOLDERED TO PCB RF GROUND



Pin Descriptions

Pin Number	Function	Description	Interface Schematic
1, 2, 6-19, 23-25, 27, 29, 31, 32	N/C	This pin may be connected to RF/DC ground. Performance will not be affected.	
4	RFIN	This pin is AC coupled and matched to 50 Ohms.	RFIN ○ — —
30, 28, 26	Vdd1, 2, 3	Power Supply Voltage for the amplifier. External bypass capacitors of 100 pF and 2.2 μF are required.	○ Vdd1,2,3
21	RFOUT	This pin is AC coupled and matched to 50 Ohms.	— — ○ RFOUT
3, 5, 20, 22	GND	These pins and package bottom must be connected to RF/DC ground.	○ GND

Application Circuit

Component	Value
C1, C2, C3	100 pF
C4, C5, C6	2.2 μF

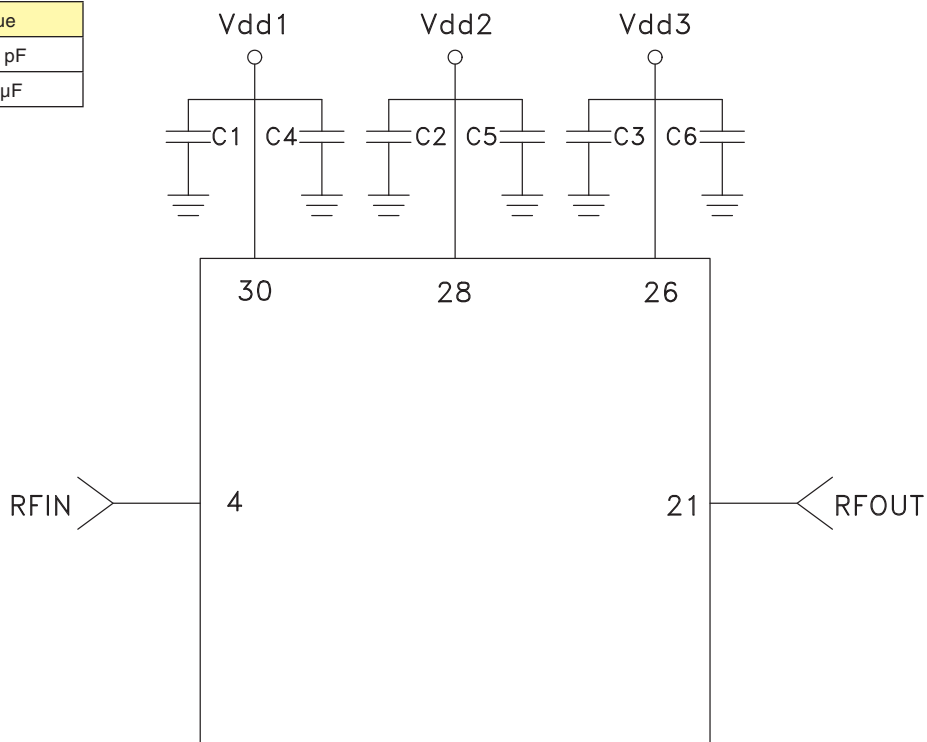

Evaluation PCB

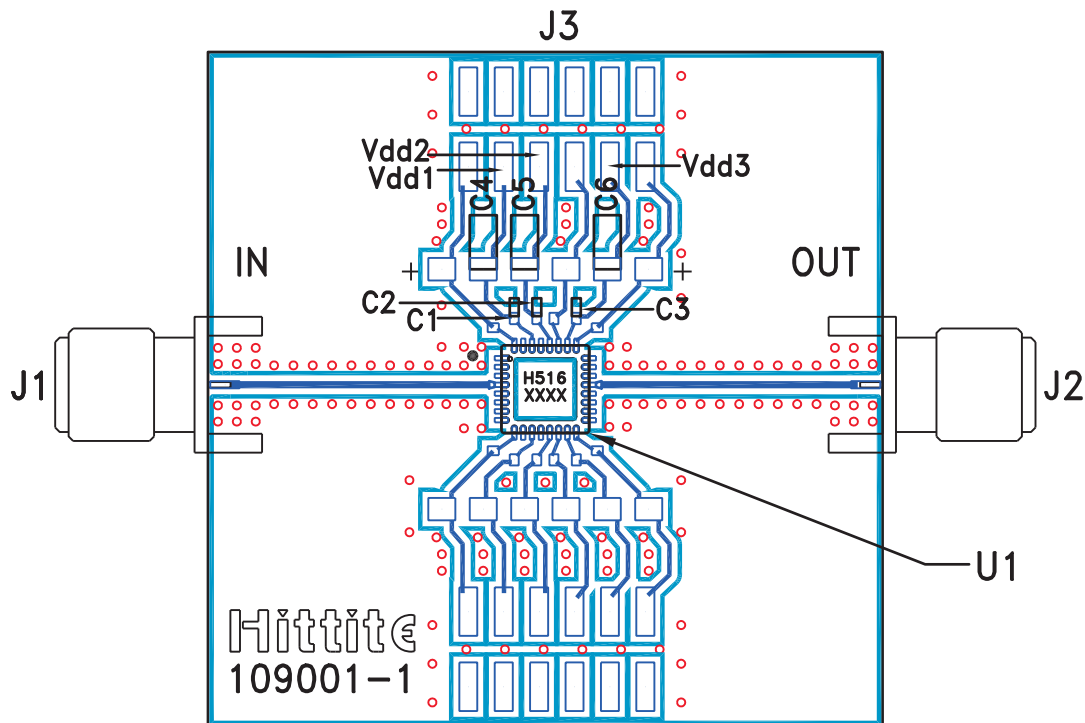

List of Materials for Evaluation PCB 110431 [1]

Item	Description
J1 - J2	PCB Mount K Connector
J3	2 mm DC Header
C1 - C3	100 pF Capacitor, 0402 Pkg.
C4 - C6	2.2 μ F Capacitor, Tantalum
U1	HMC516LC5 Amplifier
PCB [2]	109001 Evaluation PCB

[1] Reference this number when ordering complete evaluation PCB

[2] Circuit Board Material: Rogers 4350

The circuit board used in the final application should use RF circuit design techniques. Signal lines should have 50 ohm impedance while the package ground leads and exposed paddle should be connected directly to the ground plane similar to that shown. A sufficient number of via holes should be used to connect the top and bottom ground planes. The evaluation board should be mounted to an appropriate heat sink. The evaluation circuit board shown is available from Hittite upon request.