

High Collector-Emitter Voltage Type Photocoupler

LTV-702F Series

Features

- High collector-emitter voltage($V_{CEO}=70V$)
- High input-output isolation voltage:
($V_{iso} : 5,000V_{rms}$)
- Directly connectable to TTL
- UL approved (No. E113898)
- TUV approved (No.R9653630)
- CSA approved (No. CA91533-1)
- FIMKO approved (No. 193422)
- NEMKO approved (No. P96103013)
- DEMKO approved (No. 303968)
- SEMKO approved (No. 9646047/01-30)
- VDE approved (No. 094722 Thailand)
- Options available :
 - Leads with 0.4"(10.16mm)spacing (M Type)
 - Leads bends for surface mounting(S Type)
 - Tape and Reel of Type I for SMD(Add"-TA"Suffix)
 - Tape and Reel of Type II for SMD(Add"-TA1"Suffix)
 - VDE 0884 approvals (Add"-V"Suffix)

Package Dimensions

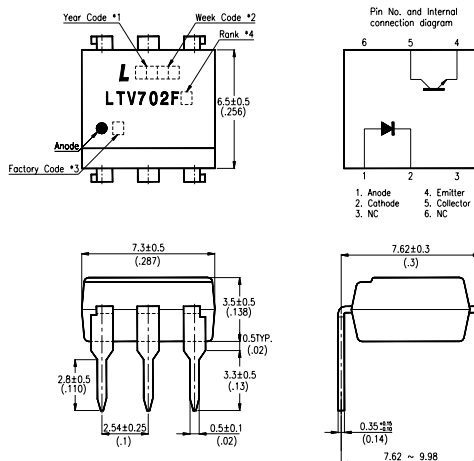

Note:

1. Year date code.
2. 2-digit work week.
3. Factory code shall be marked (Z : Taiwan, Y : Thailand).
4. Rank shall be or shall not be marked.
5. All dimensions are in millimeters (inches).
6. Tolerance is $\pm 0.25mm$ (.010") unless otherwise noted.
7. Specifications are subject to change without notice.

Applications

1. Telephone sets, telephone exchangers.
2. System appliances, measuring instruments.
3. Signal transmission between circuits of different potentials and impedances.

Ordering Information

| Part Number | Package | Safety Standard Approval | Application part number |
|--|---|---|-------------------------|
| LTV-702F LTV-702FM LTV-702FS LTV-702FS-TA LTV-702FS-TA1 | 6-pin DIP 6-pin (leads with 0.4" spacing) 6-pin (lead bends for surface mount) 6-pin (tape and reel packaging of type I) 6-pin (tape and reel packaging of type II) | <ul style="list-style-type: none"> • UL approved • TUV approved • CSA approved • FIMKO approved • NEMKO approved • SEMKO approved • DEMKO approved | LTV - 702F |
| LTV702F-V LTV702FM-V LTV702FS-V LTV702FSTA-V LTV702FSTA1-V | 6-pin DIP 6-pin (leads with 0.4" spacing) 6-pin (lead bends for surface mount) 6-pin (tape and reel packaging of type I) 6-pin (tape and reel packaging of type II) | <ul style="list-style-type: none"> • VDE approved | LTV - 702F |

Absolute Maximum Ratings

(Ta=25°C)

| Parameter | | Symbol | Rating | Unit |
|--------------------------|-----------------------------|------------------|----------|-------------------|
| Input | Forward Current | I _F | 60 | mA |
| | Reverse Voltage | V _R | 6 | V |
| | Power Dissipation | P | 105 | mW |
| Output | Collector-Emitter Voltage | V _{CEO} | 70 | V |
| | Emitter-Collector Voltage | V _{ECO} | 6 | V |
| | Collector Current | I _C | 50 | mA |
| | Collector Power Dissipation | P _C | 160 | mW |
| Total Power Dissipation | | P _{tot} | 200 | mW |
| Operating Temperature | | T _{opr} | -55~+100 | °C |
| Storage Temperature | | T _{stg} | -55~+150 | °C |
| *1.Isolation Voltage | | V _{iso} | 5 | KV _{rms} |
| *2.Soldering Temperature | | T _{sol} | 260 | °C |

*1. AC for 1 minute, R.H. = 40 ~ 60%

• Isolation voltage shall be measured using the following method.

(1) Short between anode and cathode on the primary side and between collector, emitter and base on the secondary side.

(2) The isolation voltage tester with zero-cross circuit shall be used.

(3) The waveform of applied voltage shall be a sine wave.

*2. For 10 seconds.

Electrical/Optical Characteristics

(Ta=25°C)

| Parameter | | Symbol | Min. | Typ. | Max. | Unit | Conditions |
|--------------------------|--------------------------------------|----------------------|----------------------|------------------|------|------|---|
| Input | Forward Voltage | V _F | — | 1.4 | 1.7 | V | I _F =60mA |
| | Reverse Current | I _R | — | — | 10 | μA | V _R =6V |
| | Terminal Capacitance | C _t | — | 30 | 250 | pF | V=0, f=1KHz |
| Output | Collector Dark Current | I _{CEO} | — | — | 50 | nA | V _{CE} =10V |
| | Collector-Emitter Breakdown Voltage | BV _{CEO} | 70 | — | — | V | I _C =0.1mA |
| | Emitter-Collector Breakdown Voltage | BV _{ECO} | 6 | — | — | V | I _E =10 μA |
| Transfer Characteristics | Collector Current | I _C | 4 | — | 32 | mA | I _F =10mA V _{CE} =5V |
| | *Current Transfer Ratio | CTR | 40 | — | 320 | % | I _F =10mA V _{CE} =5V |
| | Collector-emitter Saturation Voltage | V _{CE(sat)} | — | 0.25 | 0.4 | V | I _F =10mA, I _C =2.5mA |
| | Isolation Resistance | R _{iso} | 5 × 10 ¹⁰ | 10 ¹¹ | — | Ω | DC500V, 40~60% R.H. |
| | Floating Capacitance | C _f | — | 0.6 | 1.0 | pF | V=0, f=1MHz |
| | Cut-off Frequency | f _c | — | 150 | — | KHz | V _{CC} =5V, I _F =10mA R _L =75 Ω, -3dB |
| | Response Time (Rise) | t _r | — | 2 | 7 | μs | V _{CC} =5V, I _F =10mA |
| | Response Time (Fall) | t _f | — | 2 | 8 | μs | R _L =75 Ω |

$$*CTR = \frac{I_C}{I_F} \times 100\%$$

■ Supplement

Rank Table of Current Transfer Ratio CTR

| Model No. | Rank Mark | CTR(%) |
|------------|--|---------|
| LTV-702F | A | 40~80 |
| LTV-702F | B | 63~125 |
| LTV-702F | C | 100~200 |
| LTV-702F | D | 160~320 |
| LTV-702F | A or B or C or D | 40~320 |
| Conditions | I _F =10mA V _{CE} =5V Ta=25°C | |

Typical Electrical/Optical Characteristic Curves (25°C Ambient Temperature Unless Otherwise Noted)

Fig.1 Forward Current vs. Ambient Temperature

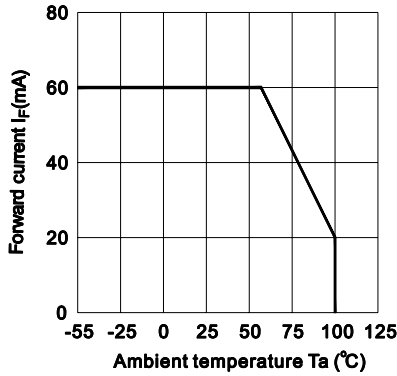

Fig.2 Collector Power Dissipation vs. Ambient Temperature

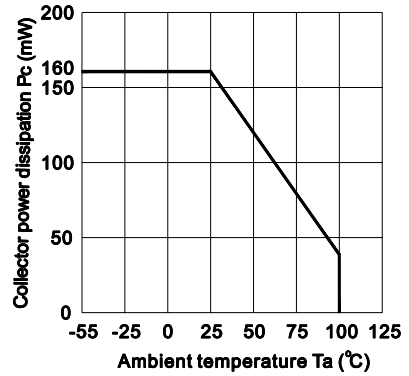

Fig.3 Frequency Response

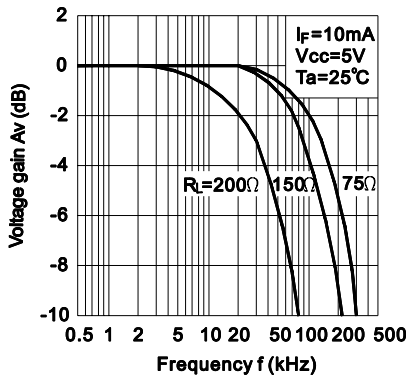

Fig.4 Forward Current vs. Forward Voltage

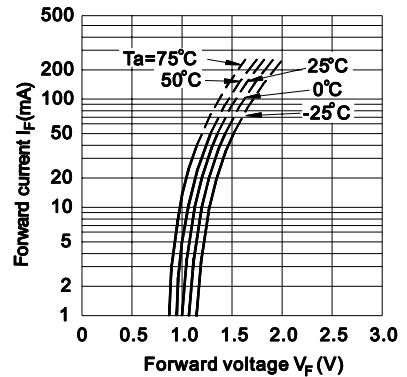

Fig.5 Current Transfer Ratio vs. Forward Current

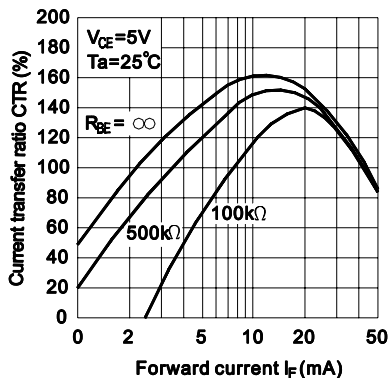
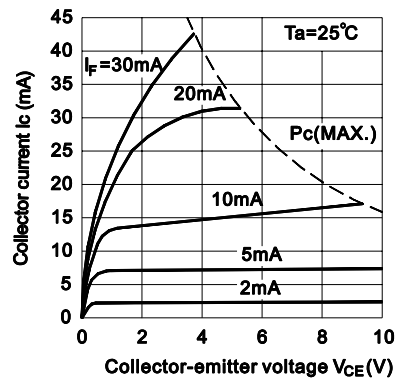

Fig.6 Collector Current vs. Collector-emitter Voltage



PHOTOCOUPLER

Fig.7 Relative Current Transfer Ratio vs. Ambient Temperature

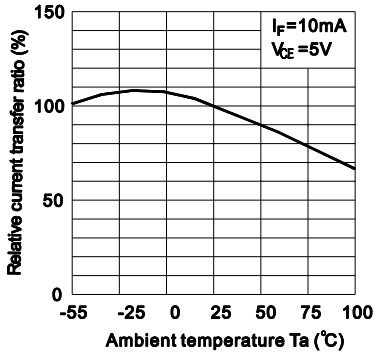

Fig.8 Collector-emitter Saturation Voltage vs. Ambient Temperature

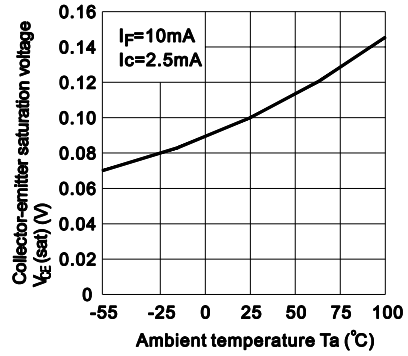

Fig.9 Collector Dark Current vs. Ambient Temperature

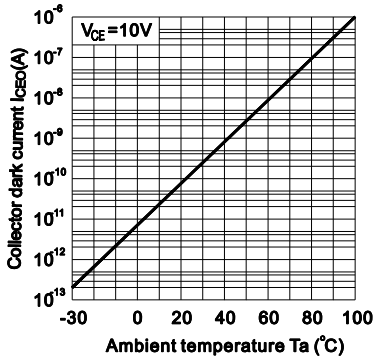

Fig.10 Response Time vs. Load Resistance

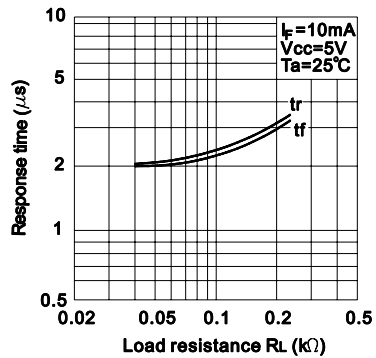
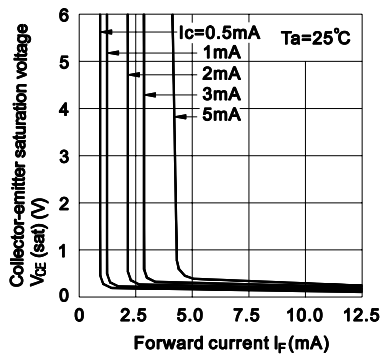
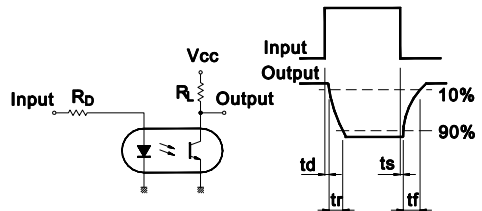

Fig.11 Collector-emitter Saturation Voltage vs. Forward Current



Test Circuit for Response Time



Test Circuit for Frequency Response

