

SN65076B, SN75076B DIFFERENTIAL BUS TRANSCEIVERS

SLLS061 – D3407, JANUARY 1990

- Bidirectional Transceiver
- Designed for Multipoint Transmission in Noisy Environments Such as Automotive Applications
- 3-State Driver and Receiver Outputs
- Individual Driver and Receiver Enables
- Wide Positive and Negative Input/Output Bus Voltage Ranges
- Driver Output Capability . . . ± 10 mA Max
- Thermal Shutdown Protection
- Driver Positive and Negative Current Limiting
- Receiver Input Impedance . . . 12 k Ω Min
- Receiver Input Sensitivity . . . ± 200 mV
- Receiver Input Hysteresis . . . 50 mV Typ
- Operates From Single 5-V Supply
- Low Power Requirements

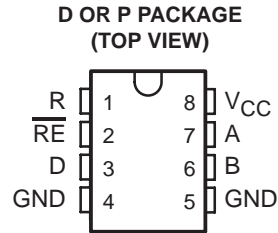

logic symbol†

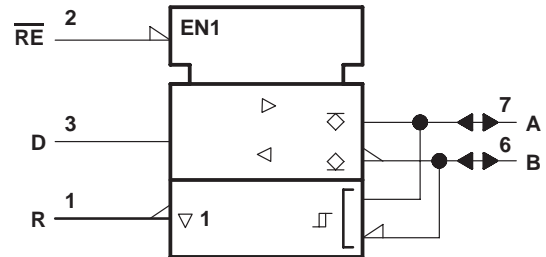

† This symbol is in accordance with ANSI/IEEE Std 91-1984 and IEC Publication 617-12.

description

The SN65076B and SN75076B differential bus transceivers are monolithic integrated circuits designed for bidirectional data communication on multipoint bus transmission lines. They are designed for noisy environments, where a low-impedance termination to ground is required.

The SN65076B and SN75076B combine a differential line driver and a differential input line receiver, both of which operate from a single 5-V power supply. The receiver has an active-low enable. The driver differential outputs and the receiver differential inputs are connected internally to form differential input/output (I/O) bus ports that are designed to offer minimum loading to the bus whenever the driver is disabled or $V_{CC} = 0$. These ports feature wide positive and negative common-mode voltage ranges making the device suitable for party-line applications.

logic diagram (positive logic)

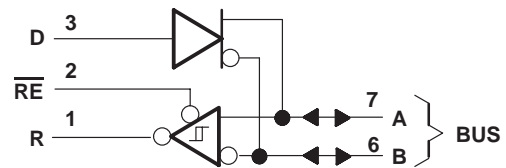

Function Tables

DRIVER

INPUT D	OUTPUTS	
	A	B
H	H	L
L	L†	H†

† These levels assume that the open-collector outputs (A) and the open-emitter outputs (B) are connected to a pullup and pulldown resistor, respectively.

RECEIVER

DIFFERENTIAL INPUTS A – B	ENABLE RE	OUTPUT R
$V_{ID} \geq 0.2$ V	L	L
-0.2 V $< V_{ID} < 0.2$ V	L	?
$V_{ID} \leq -0.2$ V	L	H
X	H	Z

H = high level, L = low level, ? = indeterminate;
X = irrelevant, Z = high impedance (off)

SN65076B, SN75076B DIFFERENTIAL BUS TRANSCEIVERS

SLLS061 – D3407, JANUARY 1990

description (continued)

The driver is designed to handle loads up to 10 mA of sink and source current. The driver features positive- and negative-current limiting and thermal shutdown for protection from line fault conditions. Thermal shutdown is designed to occur at a junction temperature of approximately 150°C in the P package and 170°C in the D package. The receiver features a minimum input impedance of 12 kΩ, an input sensitivity of ±200 mV, and a typical input hysteresis of 50 mV.

The SN65076B is characterized for operation from -40°C to 105°C and the SN75076B is characterized for operation from 0°C to 70°C.

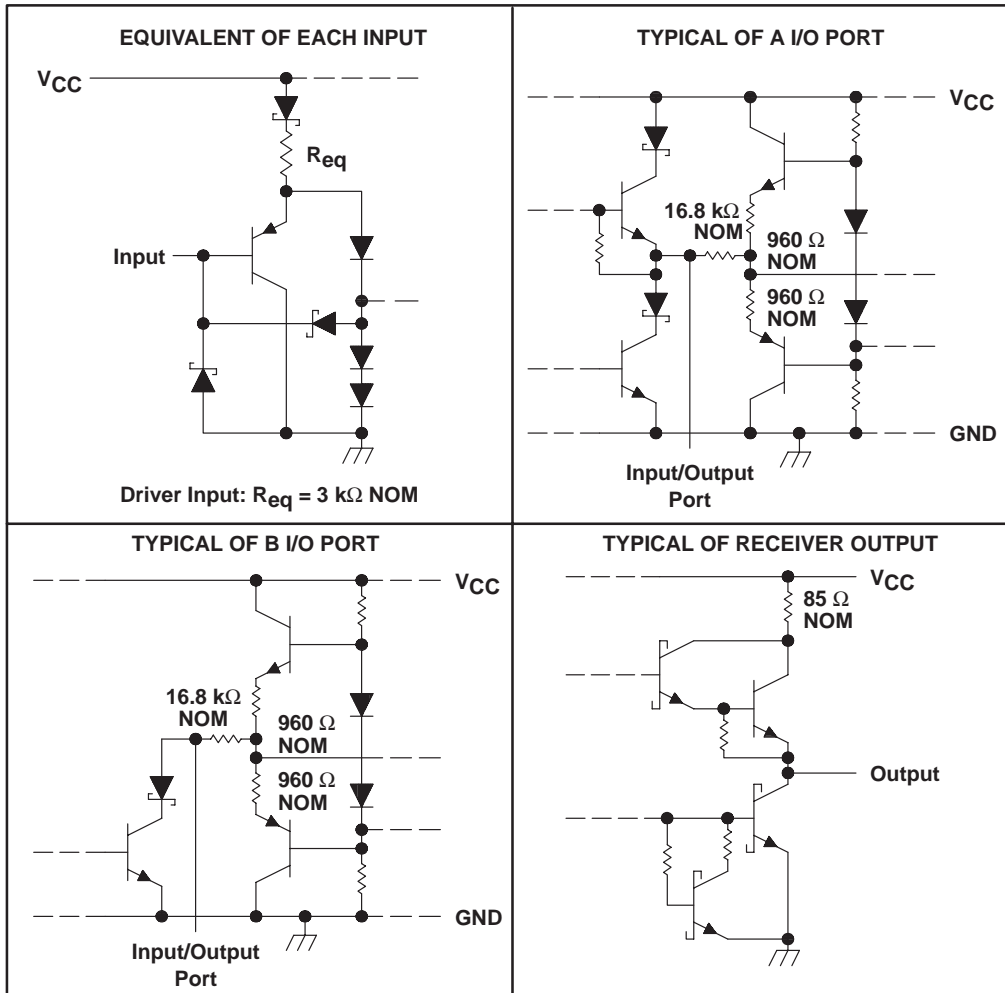

SN65076B, SN75076B DIFFERENTIAL BUS TRANSCEIVERS

SLLS061 – D3407, JANUARY 1990

absolute maximum ratings over operating free-air temperature range (unless otherwise noted)

Supply voltage, V_{CC} (see Note 1)	7 V
Voltage range at any bus terminal	–10 V to 15 V
Enable input voltage	5.5 V
Continuous total power dissipation	See Dissipation Rating Table
Operating free-air temperature range: SN65076B	–40°C to 105°C
SN75076B	0°C to 70°C
Storage temperature range	–65°C to 150°C
Lead temperature 1,6 mm (1/16 inch) from the case for 10 seconds	260°C

NOTE 1: All voltage values, except differential input/output bus voltage, are with respect to network ground terminal.

DISSIPATION RATING TABLE

PACKAGE	$T_A \leq 25^\circ\text{C}$ POWER RATING	DERATING FACTOR ABOVE $T_A = 25^\circ\text{C}$	$T_A = 70^\circ\text{C}$ POWER RATING	$T_A = 105^\circ\text{C}$ POWER RATING
D	725 mW	5.8 mW/°C	464 mW	261 mW
P	1100 mW	8.8 mW/°C	702 mW	396 mW

recommended operating conditions

		MIN	NOM	MAX	UNIT
Supply voltage, V_{CC}		4.75	5	5.25	V
Voltage at any bus terminal (separately or common mode), V_I or V_{IC}				12	V
				–7	
High-level input voltage, V_{IH}	D and \overline{RE}	2			V
Low-level input voltage, V_{IL}	D and \overline{RE}			0.8	V
Differential input voltage, V_{ID} (see Note 2)				±12	V
High-level output current, I_{OH}	Driver (A)			–10	mA
	Receiver			–400	µA
Low-level output current, I_{OL}	Driver (B)			10	mA
	Receiver			8	
Operating free-air temperature, T_A	SN65076B	–40		105	°C
	SN75076B	0		70	

NOTE 2: Differential-input/output bus voltage is measured at the noninverting terminal A with respect to the inverting terminal B.



SN65076B, SN75076B DIFFERENTIAL BUS TRANSCEIVERS

SLLS061 – D3407, JANUARY 1990

DRIVER SECTION

electrical characteristics over recommended ranges of supply voltage and operating free-air temperature

PARAMETER		TEST CONDITIONS	MIN	MAX	UNIT
V_{IK}	Input clamp voltage	$I_I = -18 \text{ mA}$		-1.5	V
V_O	Output voltage	$V_I = 2 \text{ V}, I_O = 0$	0	6	V
V_{OD1}	Differential output voltage	$I_O = 0$	1.5	6	V
V_{OD2}	Differential output voltage	See Figure 1	1.5	5	V
I_O	Output current	$V_I = 0.8 \text{ V}$	$V_O = 12 \text{ V}$	1	mA
			$V_O = -7 \text{ V}$	-0.8	
I_{IH}	High-level input current	$V_I = 2.4 \text{ V}$		20	μA
I_{IL}	Low-level input current	$V_I = 0.4 \text{ V}$		-400	μA
I_{OS}	Short-circuit output current		$V_O = -7 \text{ V}$	-250	mA
			$V_O = 0$	-150	
			$V_O = V_{CC}$	250	
			$V_O = 12 \text{ V}$	250	
I_{CC}	Supply current (total package)	No load		30	mA

switching characteristics, $V_{CC} = 5 \text{ V}, T_A = 25^\circ\text{C}$

PARAMETER		TEST CONDITIONS	MIN	TYP	MAX	UNIT
t_{on}	Differential-output turn-on time	See Figure 3		60	90	ns
t_{off}	Differential-output turn-off time			75	110	ns

RECEIVER SECTION

electrical characteristics over recommended ranges of common-mode input voltage, supply voltage, and operating free-air temperature (unless otherwise noted)

PARAMETER		TEST CONDITIONS	MIN	TYP†	MAX	UNIT
V_{T+}	Positive-going input threshold voltage	$V_O = 2.7\text{ V}$, $I_O = -0.4\text{ mA}$			0.2	V
V_{T-}	Negative-going input threshold voltage	$V_O = 0.5\text{ V}$, $I_O = 8\text{ mA}$	$-0.2\ddagger$			V
V_{hys}	Hysteresis ($V_{T+} - V_{T-}$)			50		mV
V_{IK}	Enable-input clamp voltage	$I_I = -18\text{ mA}$			-1.5	V
V_{OH}	High-level output voltage	$V_{ID} = -200\text{ mV}$, See Figure 2		2.7		V
V_{OL}	Low-level output voltage	$V_{ID} = -200\text{ mV}$, See Figure 2			0.45	V
I_{OZ}	High-impedance-state output current	$V_O = 0.4\text{ V to }2.4\text{ V}$			± 20	μA
I_I	Line input current	Other input = 0 V, $V_I = 12\text{ V}$, $V_I = -7\text{ V}$, See Note 3			1 -0.8	mA
I_{IH}	High-level enable-input current	$V_{IH} = 2.7\text{ V}$			20	μA
I_{IL}	Low-level enable-input current	$V_{IL} = 0.4\text{ V}$			-100	μA
r_i	Input resistance			12		k Ω
I_{OS}	Short-circuit output current			-15	-85	mA
I_{CC}	Supply current (total package)	No load			30	mA

† All typical values are at $V_{CC} = 5\text{ V}$, $T_A = 25^\circ\text{C}$.

‡ The algebraic convention, in which the less-positive (more-negative) limit is designated minimum, is used in this data sheet for threshold voltage levels only.

NOTE 3: This applies for both power on and power off.

switching characteristics, $V_{CC} = 5\text{ V}$, $C_L = 15\text{ pF}$, $T_A = 25^\circ\text{C}$

PARAMETER		TEST CONDITIONS	MIN	TYP	MAX	UNIT
t_{PLH}	Propagation delay time, low-to-high level output	$V_{ID} = 0\text{ to }3\text{ V}$, See Figure 4		21	35	ns
t_{PHL}	Propagation delay time, high-to-low level output			23	35	ns
t_{PZH}	Output enable time to high level	See Figure 5		10	20	ns
t_{PZL}	Output enable time to low level			12	20	ns
t_{PHZ}	Output disable time from high level	See Figure 5		20	35	ns
t_{PLZ}	Output disable time from low level			17	25	ns

SN65076B, SN75076B DIFFERENTIAL BUS TRANSCEIVERS

SLLS061 – D3407, JANUARY 1990

PARAMETER MEASUREMENT INFORMATION

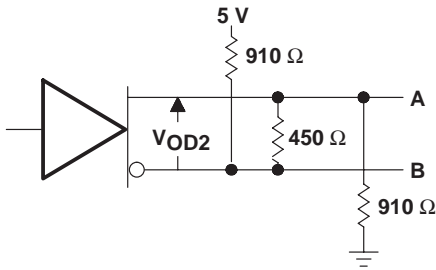

Figure 1. Driver V_{OD2}

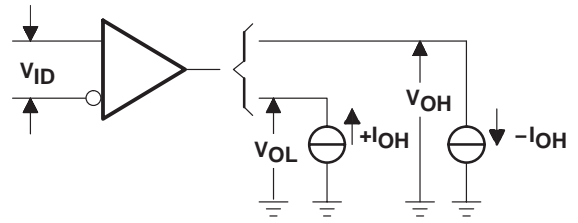
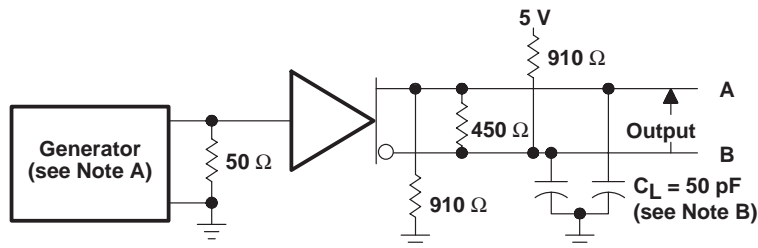
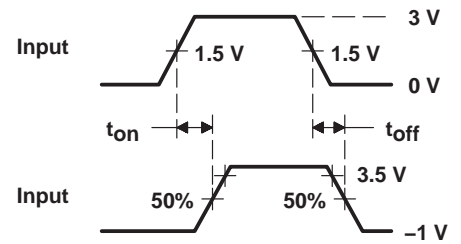

Figure 2. Receiver V_{OH} and V_{OL}



TEST CIRCUIT

Figure 3. Driver Differential-Output Delay Times



VOLTAGE WAVEFORMS

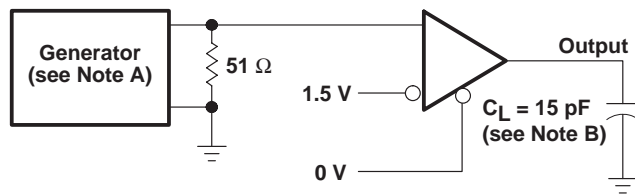

TEST CIRCUIT

Figure 4. Receiver Test Circuit and Voltage Waveforms Propagation Delay Times

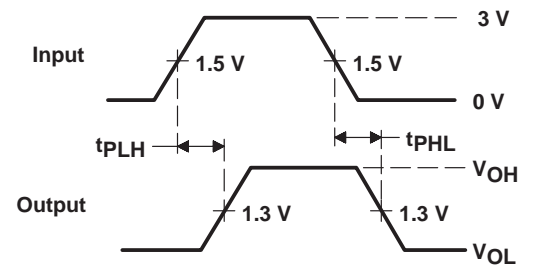

VOLTAGE WAVEFORMS

- NOTES: A. The input pulse is supplied by a generator having the following characteristics: PRR \leq 500 kHz, 50% duty cycle, $t_r \leq$ 6 ns, $t_f \leq$ 6 ns, $Z_O = 50 \Omega$.
B. C_L includes probe and jig capacitance.

PARAMETER MEASUREMENT INFORMATION

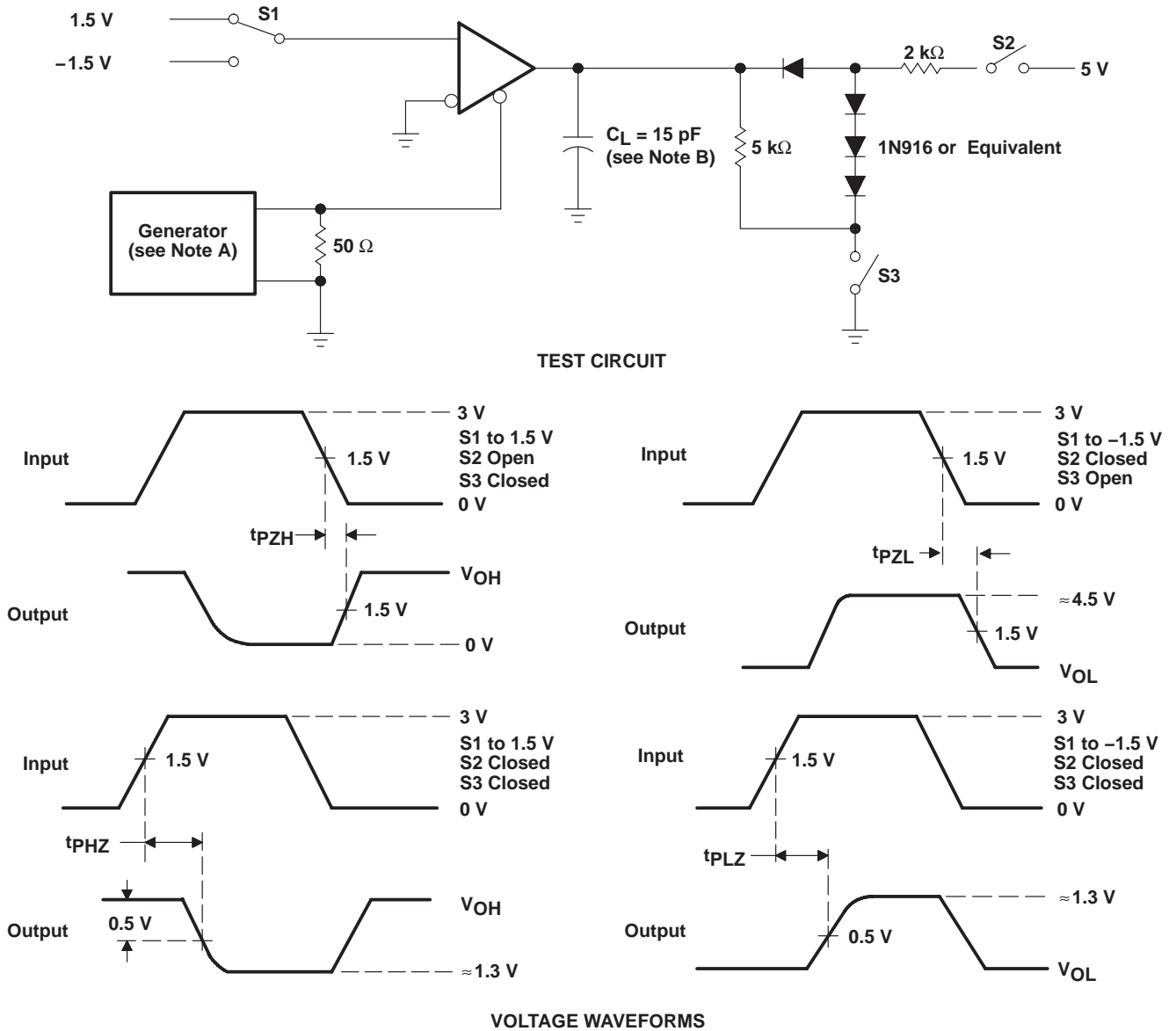

Figure 5. Receiver Output Enable and Disable Times

- NOTES: A. The input pulse is supplied by a generator having the following characteristics: PRR \leq 500 kHz, 50% duty cycle, $t_r \leq 6$ ns, $t_f \leq 6$ ns, $Z_O = 50 \Omega$.
 B. C_L includes probe and jig capacitance.

SN65076B, SN75076B DIFFERENTIAL BUS TRANSCEIVERS

SLLS061 – D3407, JANUARY 1990

TYPICAL CHARACTERISTICS

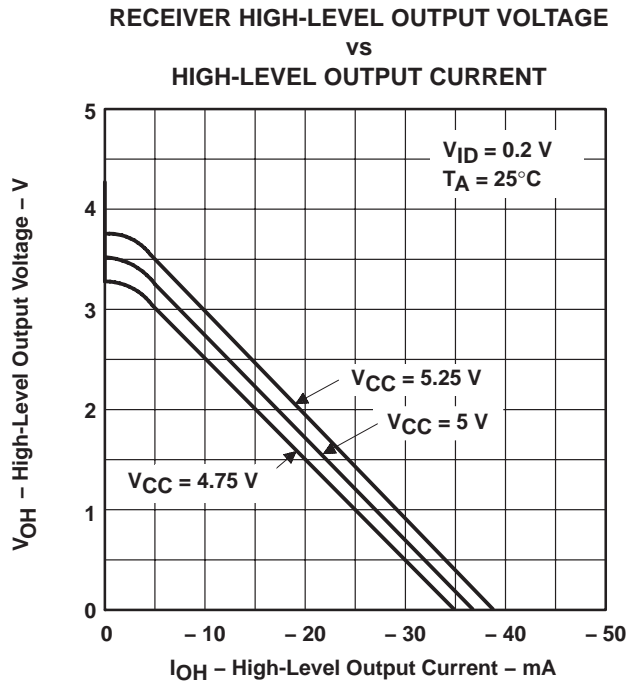

Figure 6

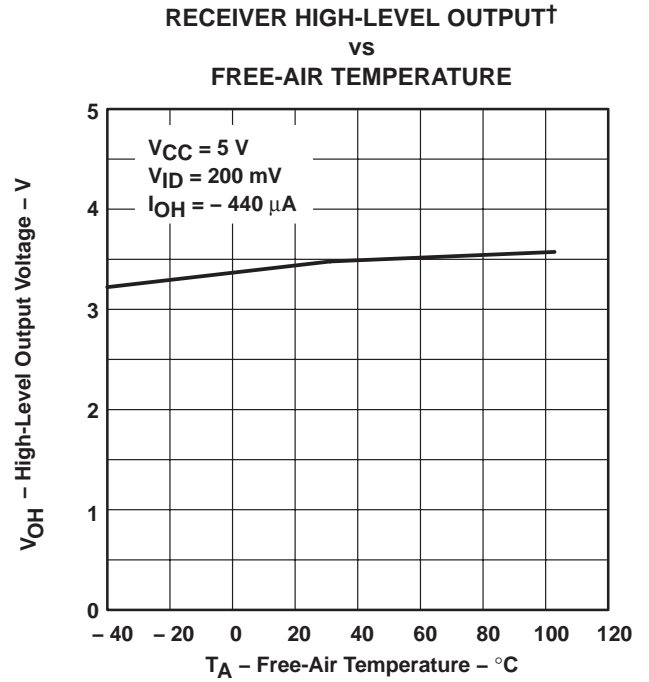

Figure 7

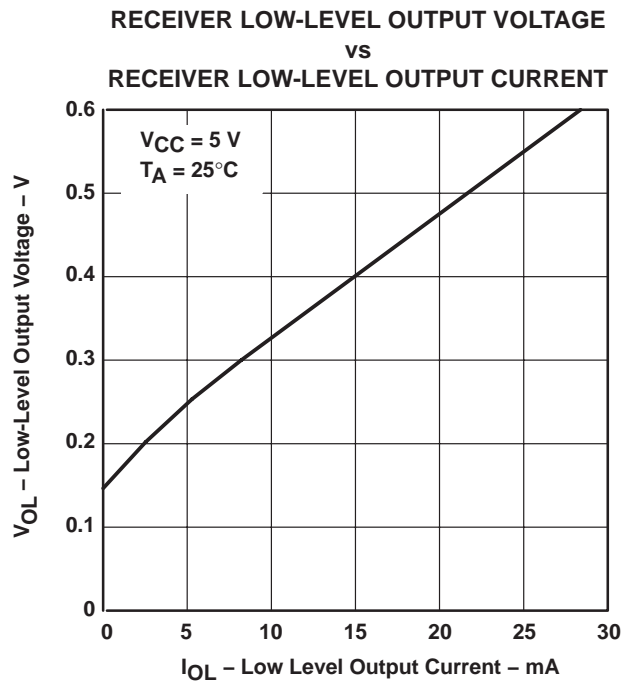

Figure 8

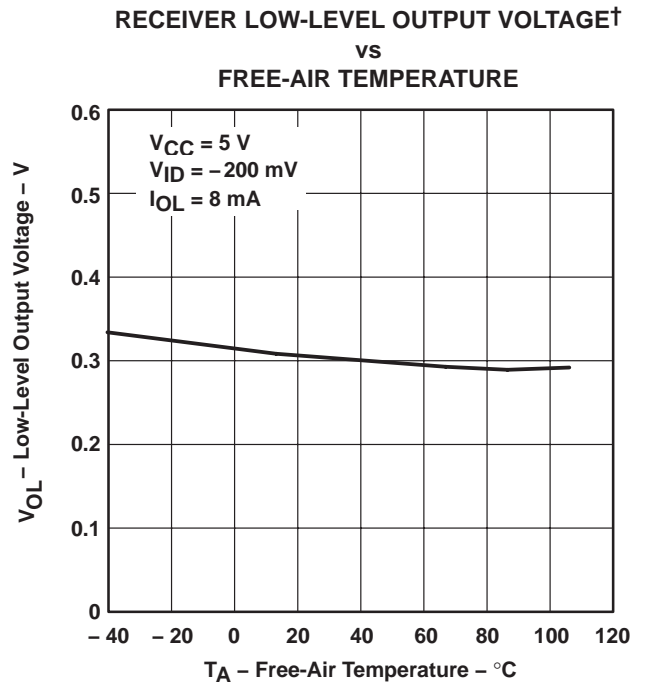

Figure 9

† Only the 0°C to 70°C portion of the curve applies for the SN75076B.

TYPICAL CHARACTERISTICS

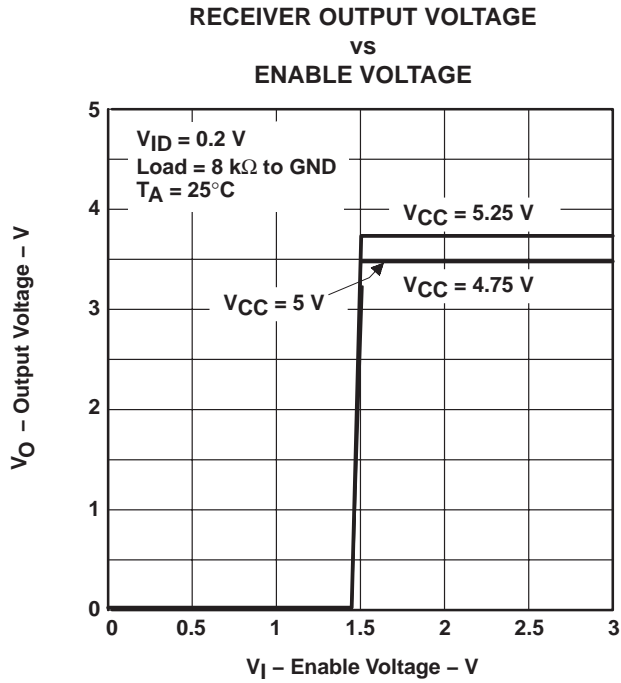

Figure 10

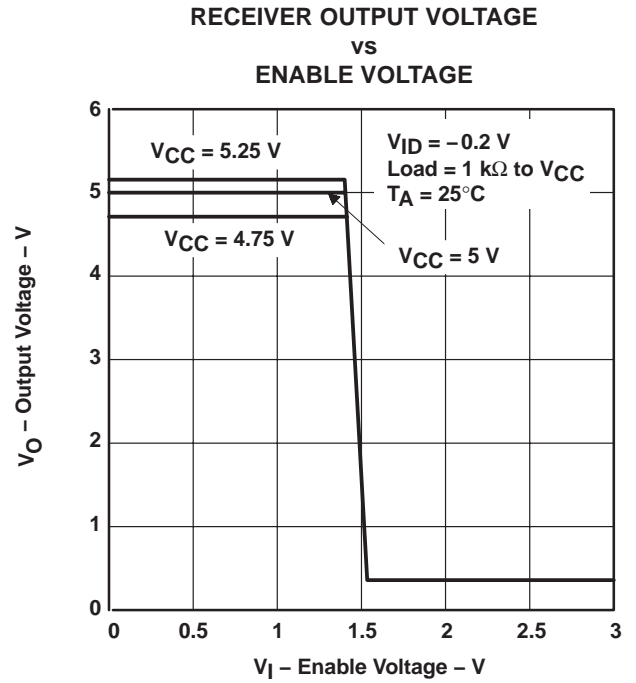

Figure 11

APPLICATION INFORMATION

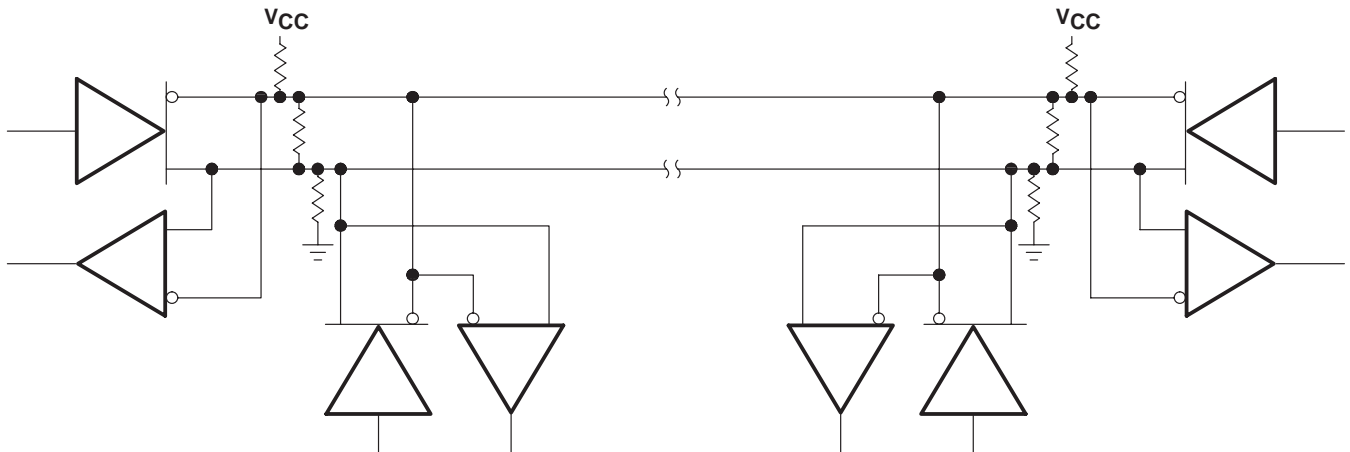

Figure 12. Typical Application Circuit

IMPORTANT NOTICE

Texas Instruments Incorporated and its subsidiaries (TI) reserve the right to make corrections, modifications, enhancements, improvements, and other changes to its products and services at any time and to discontinue any product or service without notice. Customers should obtain the latest relevant information before placing orders and should verify that such information is current and complete. All products are sold subject to TI's terms and conditions of sale supplied at the time of order acknowledgment.

TI warrants performance of its hardware products to the specifications applicable at the time of sale in accordance with TI's standard warranty. Testing and other quality control techniques are used to the extent TI deems necessary to support this warranty. Except where mandated by government requirements, testing of all parameters of each product is not necessarily performed.

TI assumes no liability for applications assistance or customer product design. Customers are responsible for their products and applications using TI components. To minimize the risks associated with customer products and applications, customers should provide adequate design and operating safeguards.

TI does not warrant or represent that any license, either express or implied, is granted under any TI patent right, copyright, mask work right, or other TI intellectual property right relating to any combination, machine, or process in which TI products or services are used. Information published by TI regarding third-party products or services does not constitute a license from TI to use such products or services or a warranty or endorsement thereof. Use of such information may require a license from a third party under the patents or other intellectual property of the third party, or a license from TI under the patents or other intellectual property of TI.

Reproduction of TI information in TI data books or data sheets is permissible only if reproduction is without alteration and is accompanied by all associated warranties, conditions, limitations, and notices. Reproduction of this information with alteration is an unfair and deceptive business practice. TI is not responsible or liable for such altered documentation. Information of third parties may be subject to additional restrictions.

Resale of TI products or services with statements different from or beyond the parameters stated by TI for that product or service voids all express and any implied warranties for the associated TI product or service and is an unfair and deceptive business practice. TI is not responsible or liable for any such statements.

TI products are not authorized for use in safety-critical applications (such as life support) where a failure of the TI product would reasonably be expected to cause severe personal injury or death, unless officers of the parties have executed an agreement specifically governing such use. Buyers represent that they have all necessary expertise in the safety and regulatory ramifications of their applications, and acknowledge and agree that they are solely responsible for all legal, regulatory and safety-related requirements concerning their products and any use of TI products in such safety-critical applications, notwithstanding any applications-related information or support that may be provided by TI. Further, Buyers must fully indemnify TI and its representatives against any damages arising out of the use of TI products in such safety-critical applications.

TI products are neither designed nor intended for use in military/aerospace applications or environments unless the TI products are specifically designated by TI as military-grade or "enhanced plastic." Only products designated by TI as military-grade meet military specifications. Buyers acknowledge and agree that any such use of TI products which TI has not designated as military-grade is solely at the Buyer's risk, and that they are solely responsible for compliance with all legal and regulatory requirements in connection with such use.

TI products are neither designed nor intended for use in automotive applications or environments unless the specific TI products are designated by TI as compliant with ISO/TS 16949 requirements. Buyers acknowledge and agree that, if they use any non-designated products in automotive applications, TI will not be responsible for any failure to meet such requirements.

Following are URLs where you can obtain information on other Texas Instruments products and application solutions:

Products		Applications	
Amplifiers	amplifier.ti.com	Audio	www.ti.com/audio
Data Converters	dataconverter.ti.com	Automotive	www.ti.com/automotive
DLP® Products	www.dlp.com	Communications and Telecom	www.ti.com/communications
DSP	dsp.ti.com	Computers and Peripherals	www.ti.com/computers
Clocks and Timers	www.ti.com/clocks	Consumer Electronics	www.ti.com/consumer-apps
Interface	interface.ti.com	Energy	www.ti.com/energy
Logic	logic.ti.com	Industrial	www.ti.com/industrial
Power Mgmt	power.ti.com	Medical	www.ti.com/medical
Microcontrollers	microcontroller.ti.com	Security	www.ti.com/security
RFID	www.ti-rfid.com	Space, Avionics & Defense	www.ti.com/space-avionics-defense
RF/IF and ZigBee® Solutions	www.ti.com/lprf	Video and Imaging	www.ti.com/video
		Wireless	www.ti.com/wireless-apps

Mailing Address: Texas Instruments, Post Office Box 655303, Dallas, Texas 75265
Copyright © 2010, Texas Instruments Incorporated