

Sekundaersicherung im Lieferzustand vorverrastet  
secondary lock in pre-position delivered

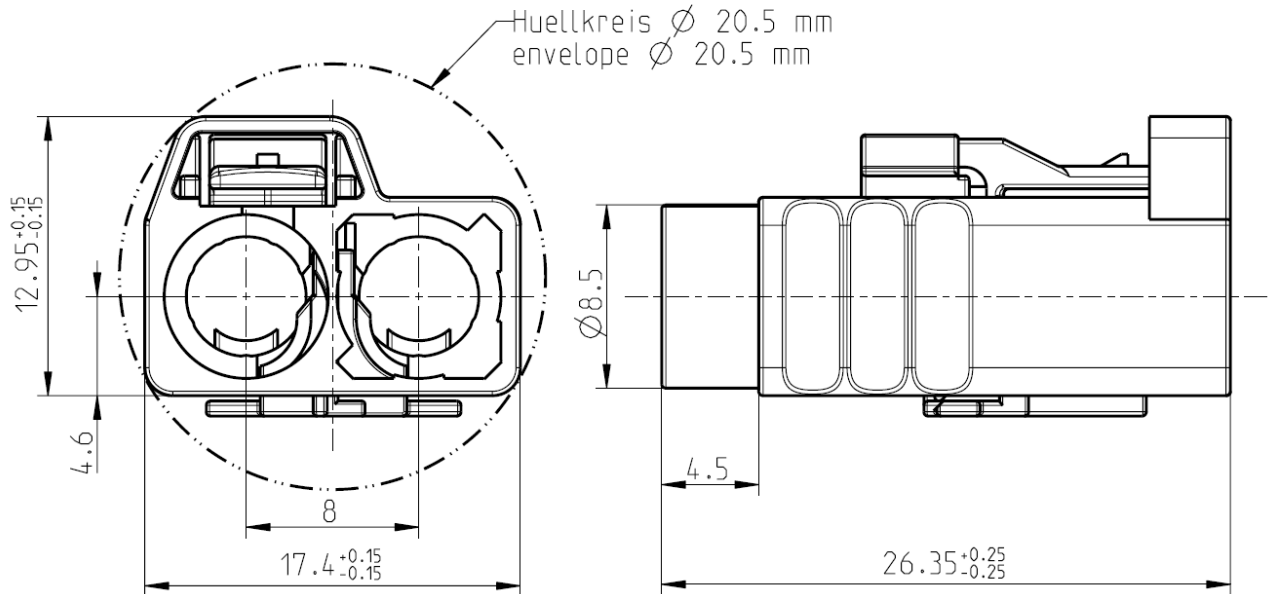
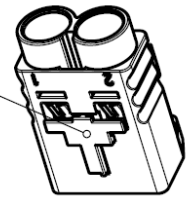

All dimensions are in mm; tolerances according to ISO 2768 m-H  
Y = Part number has to be accomplished by codification

**Interface**

According to DIN 72594-1

**Material**

Housing PBT  
Secondary Lock PBT

**Mechanical data**

Mating cycles  $\geq 25$   
Retention force latch  $\geq 110$  N  
Retention force primary lock  $\geq 80$  N  
Retention force secondary lock  $\geq 60$  N  
Coding efficiency  $\geq 40$  N

Dieses Dokument ist urheberrechtlich geschützt • This document is protected by copyright • Rosenberger Hochfrequenztechnik GmbH & Co. KG

RF\_35/05:10/6.0

**Environmental data**

Temperature range	-40°C to +105°C
Thermal shock	DIN 72594-2 clause 6.2
Temperature and humidity	DIN 72594-2 clause 6.3
Vibration and mechanical shock	DIN 72594-2 clause 6.1
Dry heat	DIN 72594-2 clause 6.4
2002/95/EC (RoHS)	compliant

**Application**

Applicable e.g. for following connectors: 59K130-1xx\*<sup>1)</sup>, 59K13D-1xx\*<sup>1)</sup>, 59K13F-1xx\*<sup>1)</sup>, 59K16A-1xx\*<sup>1)</sup>, 59K16B-1xx\*<sup>1)</sup>















\*<sup>1)</sup> -xx for all available cable variations  
-xxx

**Packing**

Standard 500 pcs in box  
Weight 2.55 g/pce

**Coding**

Part Number has to be accomplished by codification

Coding	Color	RAL	Part-Number
 A	black	sim. 9005	59Z115-000-A
 B	white	sim. 9001	59Z115-000-B
 C	blue	sim. 5005	59Z115-000-C
 D	bordeauxviolet	sim. 4004	59Z115-000-D
 E	green	sim. 6002	59Z115-000-E
 F	brown	sim. 8011	59Z115-000-F
 G	grey	sim. 7031	59Z115-000-G
 H	violet	sim. 4003	59Z115-000-H
 I	beige	sim. 1001	59Z115-000-I
 K	curry	sim. 1027	59Z115-000-K
 L	carmine red	sim. 3002	59Z115-000-L* <sup>2)</sup>
 M	pastel orange	sim. 2003	59Z115-000-M* <sup>2)</sup>
 N	pastel green	sim. 6019	59Z115-000-N* <sup>2)</sup>
 Z	waterblue	sim. 5021	59Z115-000-Z
	traffic purple	sim. 4006	secondary lock

\*<sup>2)</sup> available on request

While the information has been carefully compiled to the best of our knowledge, nothing is intended as representation or warranty on our part and no statement herein shall be construed as recommendation to infringe existing patents. In the effort to improve our products, we reserve the right to make changes judged to be necessary.

Draft	Date	Approved	Date	Rev.	Engineering change number	Name	Date
F. Neureiter	14/06/10	T. Bredbeck	06/08/12	a00	12-s309	F. Hohenadl	06/08/12