



SANYO Semiconductors

DATA SHEET

An ON Semiconductor Company

15C01C — NPN Epitaxial Planar Silicon Transistor

Low-Frequency General-Purpose Amplifier Applications

Applications

- Low-frequency Amplifier, muting circuit

Features

- Large current capacity
- Low collector-to-emitter saturation voltage (resistance) $R_{CE(sat)}$ typ.= 0.58Ω [$I_C=0.7A$, $I_B=35mA$]
- Ultrasmall package facilitates miniaturization in end products
- Small ON-resistance (R_{on})

Specifications

Absolute Maximum Ratings at $T_a=25^\circ C$

Parameter	Symbol	Conditions	Ratings	Unit
Collector-to-Base Voltage	V_{CBO}		20	V
Collector-to-Emitter Voltage	V_{CEO}		15	V
Emitter-to-Base Voltage	V_{EBO}		5	V
Collector Current	I_C		700	mA
Collector Current (Pulse)	I_{CP}		1.4	A
Collector Dissipation	P_C	Mounted on a glass epoxy board (20×30×1.6mm)	300	mW
Junction Temperature	T_j		150	$^\circ C$
Storage Temperature	T_{stg}		-55 to +150	$^\circ C$

Package Dimensions

unit : mm (typ)

7013A-009

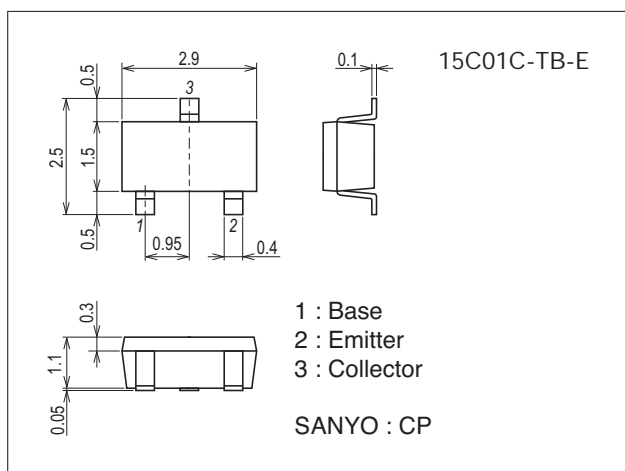

Product & Package Information

- Package : CP
- JEITA, JEDEC : SC-59, TO-236, SOT-23, TO-236AB
- Minimum Packing Quantity : 3,000 pcs./reel

Packing Type: TB

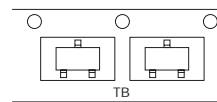

Marking

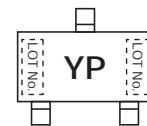

Electrical Connection

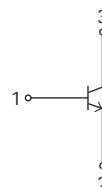

15C01C

Electrical Characteristics at Ta=25°C

Parameter	Symbol	Conditions	Ratings			Unit	
			min	typ	max		
Collector Cutoff Current	I_{CBO}	$V_{CB}=15V, I_E=0A$			0.1	μA	
Emitter Cutoff Current	I_{EBO}	$V_{EB}=4V, I_C=0A$			0.1	μA	
DC Current Gain	h_{FE}	$V_{CE}=2V, I_C=10mA$	300		800		
Gain-Bandwidth Product	f_T	$V_{CE}=2V, I_C=50mA$		330		MHz	
Output Capacitance	C_{ob}	$V_{CB}=10V, f=1MHz$		3.2		pF	
Collector-to-Emitter Saturation Voltage	$V_{CE(sat)}$	$I_C=200mA, I_B=10mA$		150	300	mV	
Base-to-Emitter Saturation Voltage	$V_{BE(sat)}$	$I_C=200mA, I_B=10mA$		0.9	1.2	V	
Collector-to-Base Breakdown Voltage	$V_{(BR)CBO}$	$I_C=10\mu A, I_E=0A$	20			V	
Collector-to-Emitter Breakdown Voltage	$V_{(BR)CEO}$	$I_C=1mA, R_{BE}=\infty$	15			V	
Emitter-to-Base Breakdown Voltage	$V_{(BR)EBO}$	$I_E=10\mu A, I_C=0A$	5			V	
Turn-On Time	t_{on}	See specified Test Circuit.		30		ns	
Storage Time	t_{stg}				77		ns
Fall Time	t_f				40		ns

Switching Time Test Circuit

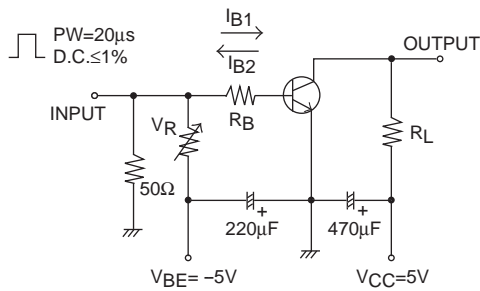

$$I_C = 20I_{B1} = -20I_{B2} = 500mA$$

Ordering Information

Device	Package	Shipping	memo
15C01C-TB-E	CP	3,000pcs./reel	Pb Free

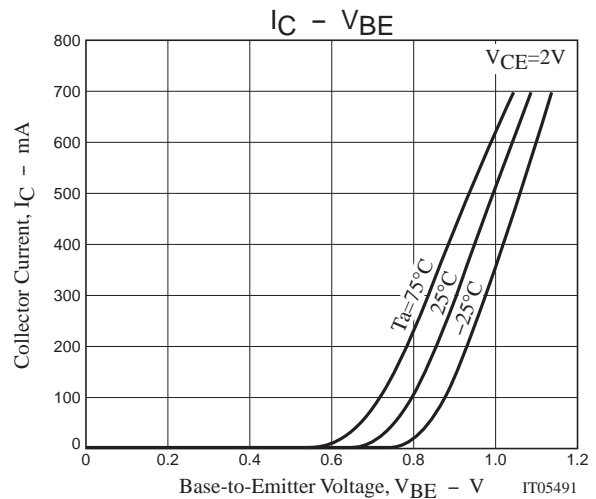
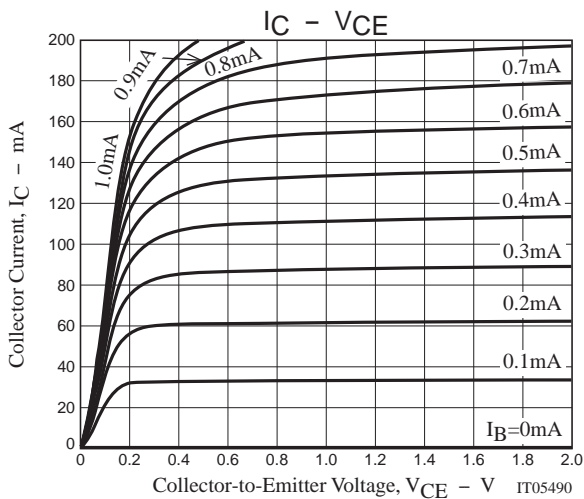

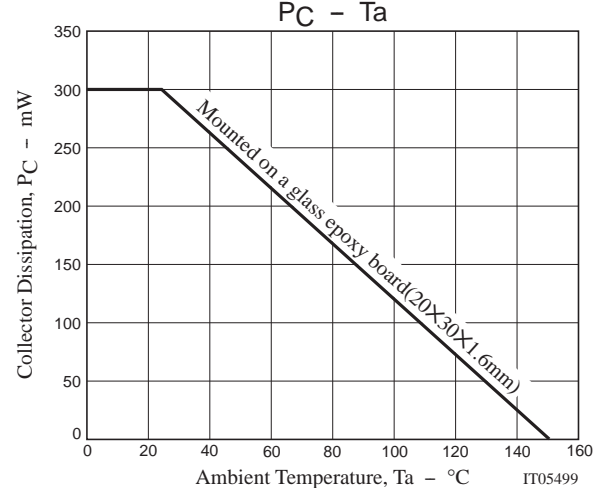
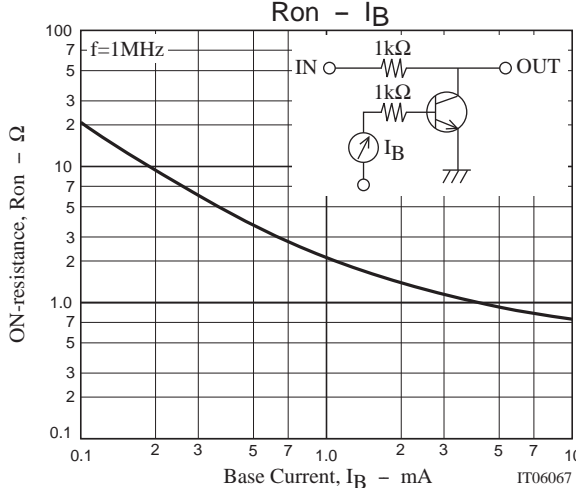
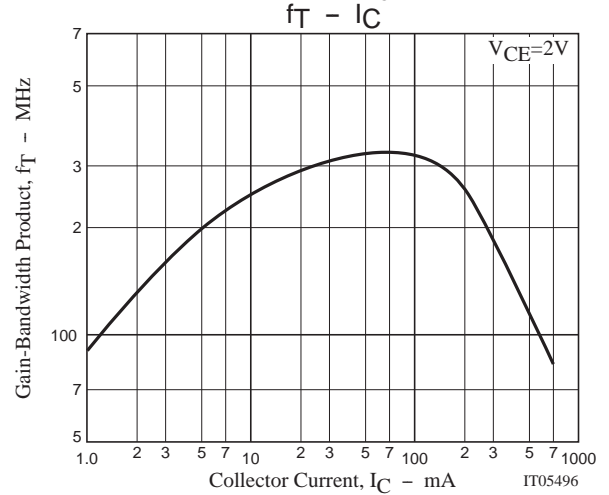
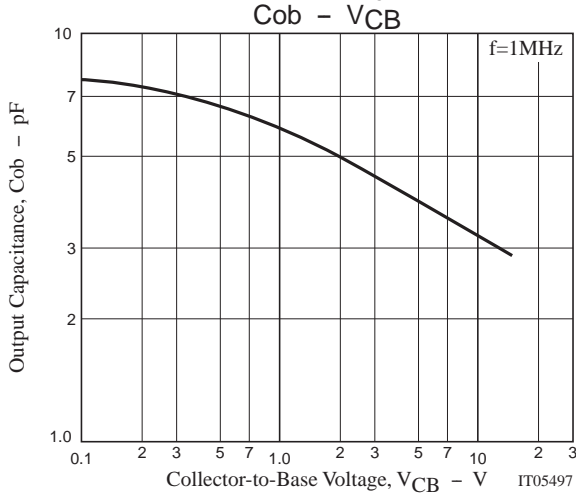
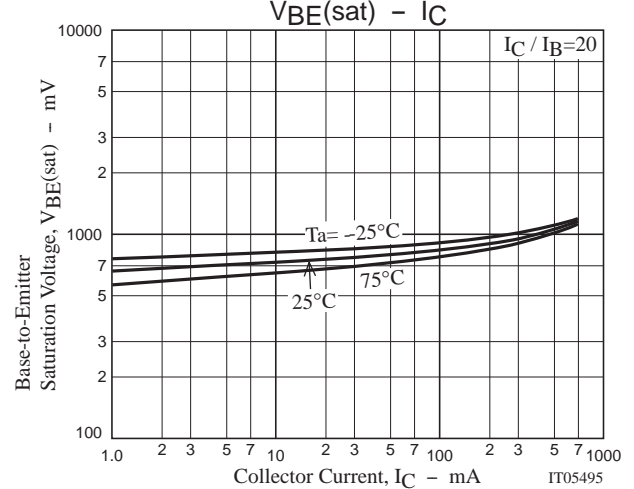
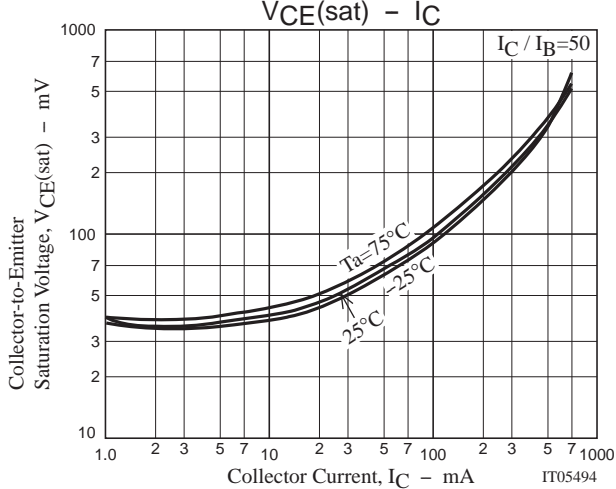
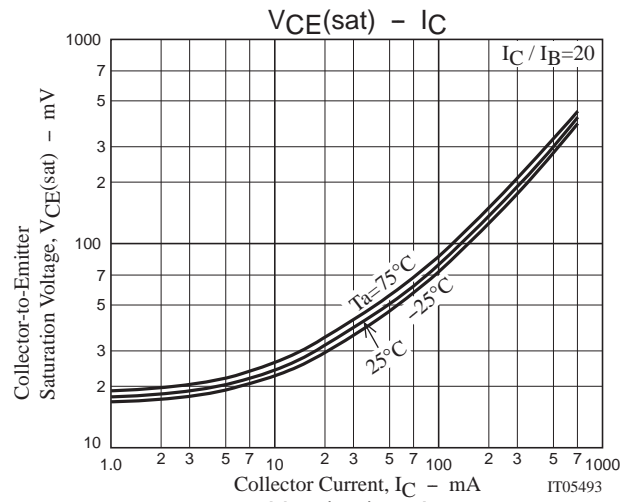
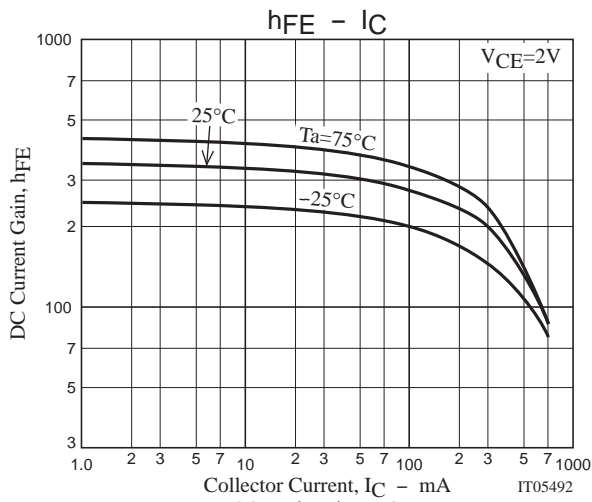

Embossed Taping Specification

15C01C-TB-E

1. Packing Format

Package Name	Carrier Tape Type	Maximum Number of devices contained (pcs)			Packing format	
		Reel	Inner box	Outer box	Inner BOX (C-1)	Outer BOX (A-7)
CP	CP	3,000	15,000	90,000	5 reels contained Dimensions:mm (external) 183×72×185	6 inner boxes contained Dimensions:mm (external) 440×195×210

Packing method

Reel label, Inner box label
(unit:mm)

Outer box label

It is a label at the time of factory shipments. The form of a label may change in physical distribution process.

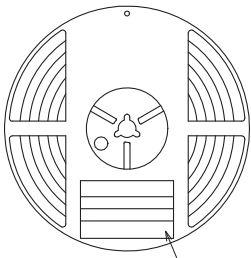

Reel label

Type No.
LOT No.
Quantity
Origin

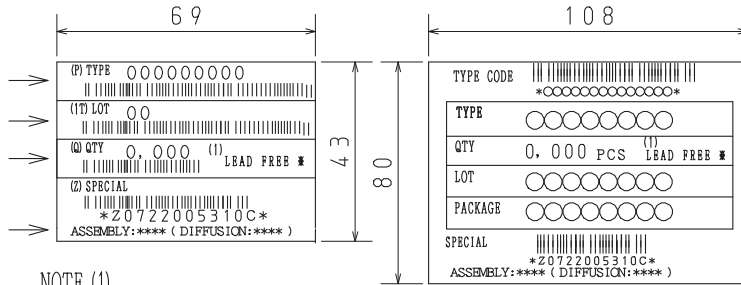

NOTE (1)

The LEAD FREE * description shows that the surface treatment of the terminal is lead free.

Label	JEITA Phase
LEAD FREE 3	JEITA Phase 3A
LEAD FREE 4	JEITA Phase 3

2. Taping configuration

2-1. Carrier tape size (unit:mm)

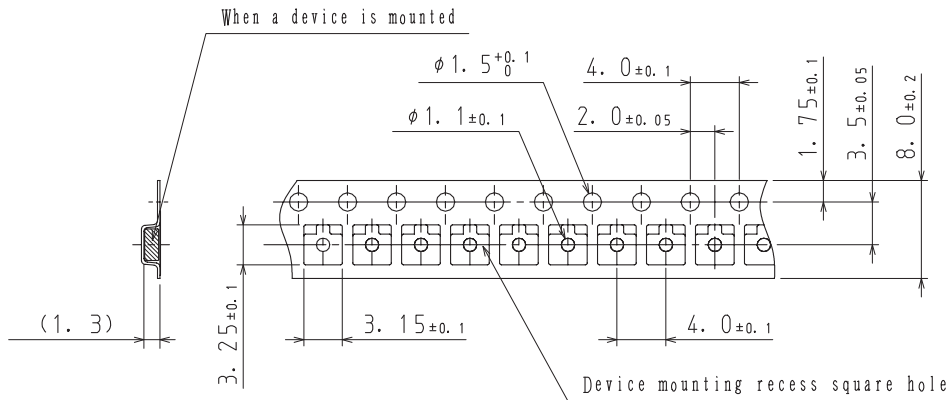

2-2. Device placement direction

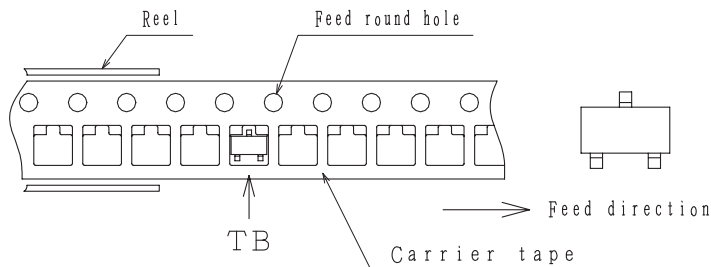

Those with one electrode terminal on the feed hole side.....TB

- Any and all SANYO Semiconductor Co.,Ltd. products described or contained herein are, with regard to "standard application", intended for the use as general electronics equipment. The products mentioned herein shall not be intended for use for any "special application" (medical equipment whose purpose is to sustain life, aerospace instrument, nuclear control device, burning appliances, transportation machine, traffic signal system, safety equipment etc.) that shall require extremely high level of reliability and can directly threaten human lives in case of failure or malfunction of the product or may cause harm to human bodies, nor shall they grant any guarantee thereof. If you should intend to use our products for new introduction or other application different from current conditions on the usage of automotive device, communication device, office equipment, industrial equipment etc. , please consult with us about usage condition (temperature, operation time etc.) prior to the intended use. If there is no consultation or inquiry before the intended use, our customer shall be solely responsible for the use.
- Specifications of any and all SANYO Semiconductor Co.,Ltd. products described or contained herein stipulate the performance, characteristics, and functions of the described products in the independent state, and are not guarantees of the performance, characteristics, and functions of the described products as mounted in the customer's products or equipment. To verify symptoms and states that cannot be evaluated in an independent device, the customer should always evaluate and test devices mounted in the customer's products or equipment.
- SANYO Semiconductor Co.,Ltd. assumes no responsibility for equipment failures that result from using products at values that exceed, even momentarily, rated values (such as maximum ratings, operating condition ranges, or other parameters) listed in products specifications of any and all SANYO Semiconductor Co.,Ltd. products described or contained herein.
- Regarding monolithic semiconductors, if you should intend to use this IC continuously under high temperature, high current, high voltage, or drastic temperature change, even if it is used within the range of absolute maximum ratings or operating conditions, there is a possibility of decrease reliability. Please contact us for a confirmation.
- SANYO Semiconductor Co.,Ltd. strives to supply high-quality high-reliability products, however, any and all semiconductor products fail or malfunction with some probability. It is possible that these probabilistic failures or malfunction could give rise to accidents or events that could endanger human lives, trouble that could give rise to smoke or fire, or accidents that could cause damage to other property. When designing equipment, adopt safety measures so that these kinds of accidents or events cannot occur. Such measures include but are not limited to protective circuits and error prevention circuits for safe design, redundant design, and structural design.
- In the event that any or all SANYO Semiconductor Co.,Ltd. products described or contained herein are controlled under any of applicable local export control laws and regulations, such products may require the export license from the authorities concerned in accordance with the above law.
- No part of this publication may be reproduced or transmitted in any form or by any means, electronic or mechanical, including photocopying and recording, or any information storage or retrieval system, or otherwise, without the prior written consent of SANYO Semiconductor Co.,Ltd.
- Any and all information described or contained herein are subject to change without notice due to product/technology improvement, etc. When designing equipment, refer to the "Delivery Specification" for the SANYO Semiconductor Co.,Ltd. product that you intend to use.
- Upon using the technical information or products described herein, neither warranty nor license shall be granted with regard to intellectual property rights or any other rights of SANYO Semiconductor Co.,Ltd. or any third party. SANYO Semiconductor Co.,Ltd. shall not be liable for any claim or suits with regard to a third party's intellectual property rights which has resulted from the use of the technical information and products mentioned above.

This catalog provides information as of September, 2012. Specifications and information herein are subject to change without notice.