

NEW

ATS Series Anti-Tampering Switches

Features/Benefits

- Normally closed function
- Vertical detect
- Reliable long time compression
- IP54
- Tape & reel
- RoHS compliant and compatible

Typical Applications

- Smart meters
- Alarm systems
- Anti-tamper devices



Specifications

FUNCTION: Momentary action.
 CONTACT TYPE: SPST Normally Closed.
 TERMINALS: Gullwing type for SMT.

Mechanical

SWITCHING FORCE: ≤ 2 N
 TRAVEL TO BREAK: 0,7 mm
 TOTAL TRAVEL: 1,1 mm

Packaging

Switches are delivered on continuous tape, in reels of 2,000 pieces

Electrical

	GOLD	SILVER
MAXIMUM POWER:	0.2 VA	1 VA
MAXIMUM VOLTAGE:	32 VDC	32 VDC
MINIMUM VOLTAGE:	20 mVDC	20 mVDC
MAXIMUM CURRENT:	10 mA	50 mA
MINIMUM CURRENT:	1 µA	1 mA
CONTACT RESISTANCE:	≤ 350 mΩ	
INSULATION RESISTANCE:	> 1 G Ω	
DIELECTRIC STRENGTH:	≥ 250 Vrms	

Environmental

	GOLD	SILVER
OPERATING TEMPERATURE:	-40°C to +125°C	-40°C to +85°C
STORAGE TEMPERATURE:	-55°C to + 125°C	-40°C to +85°C

Process

SOLDERING: Compatible with lead free reflow process

NOTE: Specifications listed above are for switches with standard options.
 For information on specific and custom switches, consult Customer Service Center.

Build-A-Switch

To order, simply select desired option from each category and place in the appropriate box. Available options are shown and described on the next page. For additional options not shown in catalog, consult Customer Service Center.

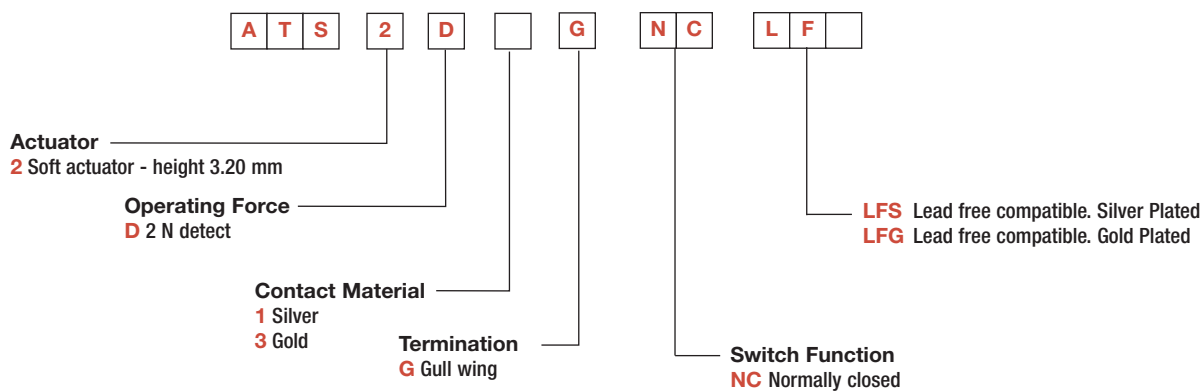

Detect

ATS Series Anti-Tampering Switches

NEW

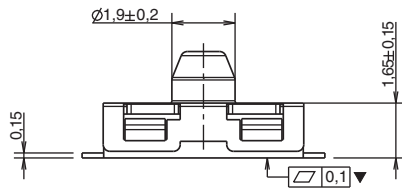

MARKING	PART NUMBER
D - 1	ATS 2D1G NC LFS
D - 3	ATS 2D3G NC LFG

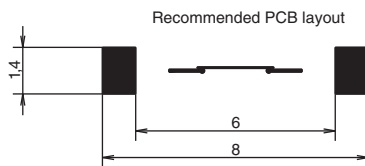
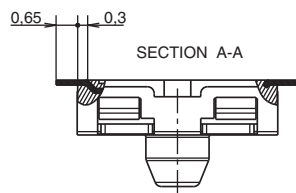
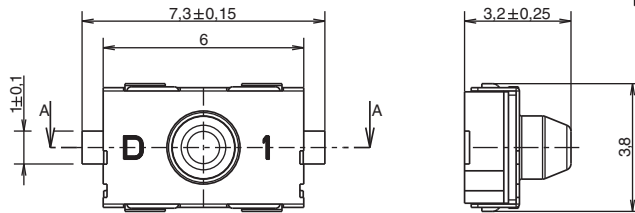

SECTION B-B

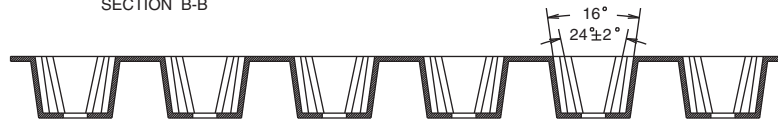

SECTION C-C

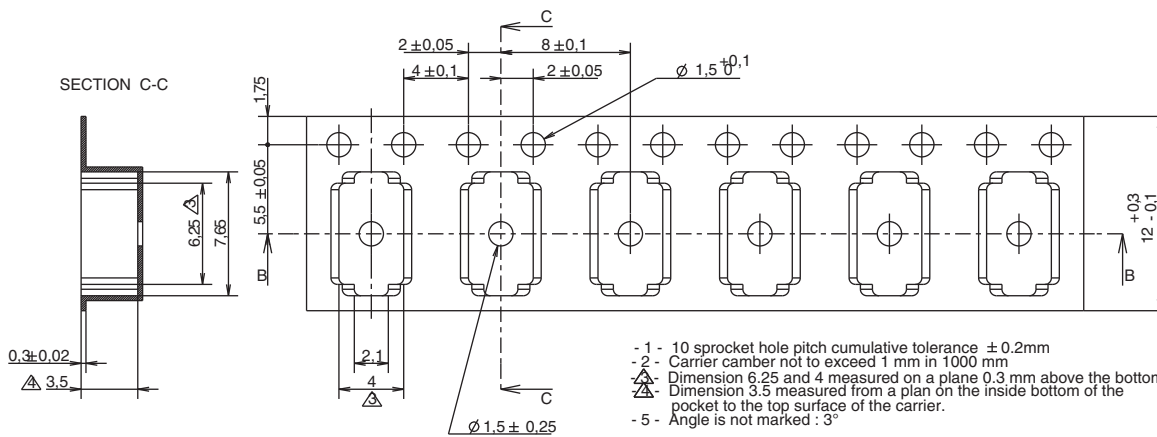

- 1 - 10 sprocket hole pitch cumulative tolerance $\pm 0.2\text{mm}$
- 2 - Carrier camber not to exceed 1 mm in 1000 mm
- 3 - Dimension 6.25 and 4 measured on a plane 0.3 mm above the bottom of the pocket
- 4 - Dimension 3.5 measured from a plan on the inside bottom of the pocket to the top surface of the carrier.
- 5 - Angle is not marked : 3°



Detect

