

FEATURES

- 400mV Dropout Voltage
- 700mA Output Current
- 50 μ A Quiescent Current
- No Protection Diodes Needed
- Adjustable Output from 3.8V to 30V
- 3.3V and 5V Fixed Output Voltages
- Controlled Quiescent Current in Dropout
- Shutdown
- 16 μ A Quiescent Current in Shutdown
- Stable with 3.3 μ F Output Capacitor
- Reverse Battery Protection
- No Reverse Output Current
- Thermal Limiting
- Surface Mount SOT-223 and DD-Pak Packages

APPLICATIONS

- Low Current Regulator
- Regulator for Battery-Powered Systems
- Post Regulator for Switching Supplies
- 5V to 3.3V Logic Regulator

DESCRIPTION

The LT[®]1129/LT1129-3.3/LT1129-5 are micropower low dropout regulators with shutdown. The devices are capable of supplying 700mA of output current with a dropout voltage of 400mV at maximum output. Designed for use in battery-powered systems, the low quiescent current, 50 μ A operating and 16 μ A in shutdown, make them an ideal choice. The quiescent current does not rise in dropout as it does with many other low dropout PNP regulators.

Other features of the LT1129/LT1129-3.3/LT1129-5 include the ability to operate with small output capacitors. They are stable with only 3.3 μ F on the output while most older devices require between 10 μ F and 100 μ F for stability. Also the input may be connected to ground or a reverse voltage without reverse current flow from output to input. This makes the LT1129/LT1129-3.3/LT1129-5 ideal for backup power situations where the output is held high and the input is at ground or reversed. Under these conditions, only 16 μ A will flow from the output pin to ground. The devices are available in 5-lead TO-220, 5-lead DD-Pak and 3-lead SOT-223 packages.

LT, LT, LTC and LTM are registered trademarks of Linear Technology Corporation. All other trademarks are the property of their respective owners.

TYPICAL APPLICATION

5V Supply with Shutdown

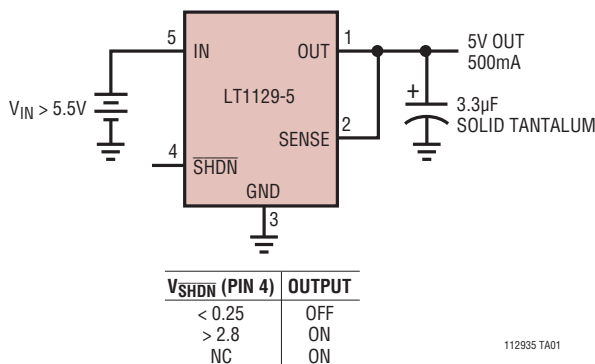

Dropout Voltage

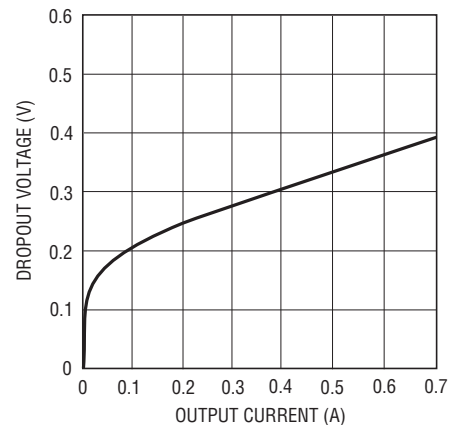

LT1129/LT1129-3.3/LT1129-5

ABSOLUTE MAXIMUM RATINGS (Note 1)

| | | | |
|---|-----------------------------|---|--|
| Input Voltage | $\pm 30V^*$ | Storage Temperature Range..... | -65°C to 150°C |
| Output Pin Reverse Current | 10mA | Operating Junction Temperature Range (Note 3) | |
| Sense Pin Current | 10mA | LT1129C-X..... | 0°C to 125°C |
| Adjust Pin Current | 10mA | LT1129C-X Extended Temperature Range | |
| Sense Pin, Adjust Pin Reverse Voltage | -0.6V | (Note 12) | -40°C to 125°C |
| Shutdown Pin Input Voltage (Note 2) | $6.5\text{V}, -0.6\text{V}$ | LT1129I-X (Note 12) | -40°C to 125°C |
| Shutdown Pin Input Current (Note 2) | 20mA | LT1129MP-X (Note 12) | -55°C to 125°C |
| Output Short-Circuit Duration | Indefinite | Lead Temperature (Soldering, 10 sec) | 300°C |

* For applications requiring input voltage ratings greater than 30V, contact the factory.

PIN CONFIGURATION

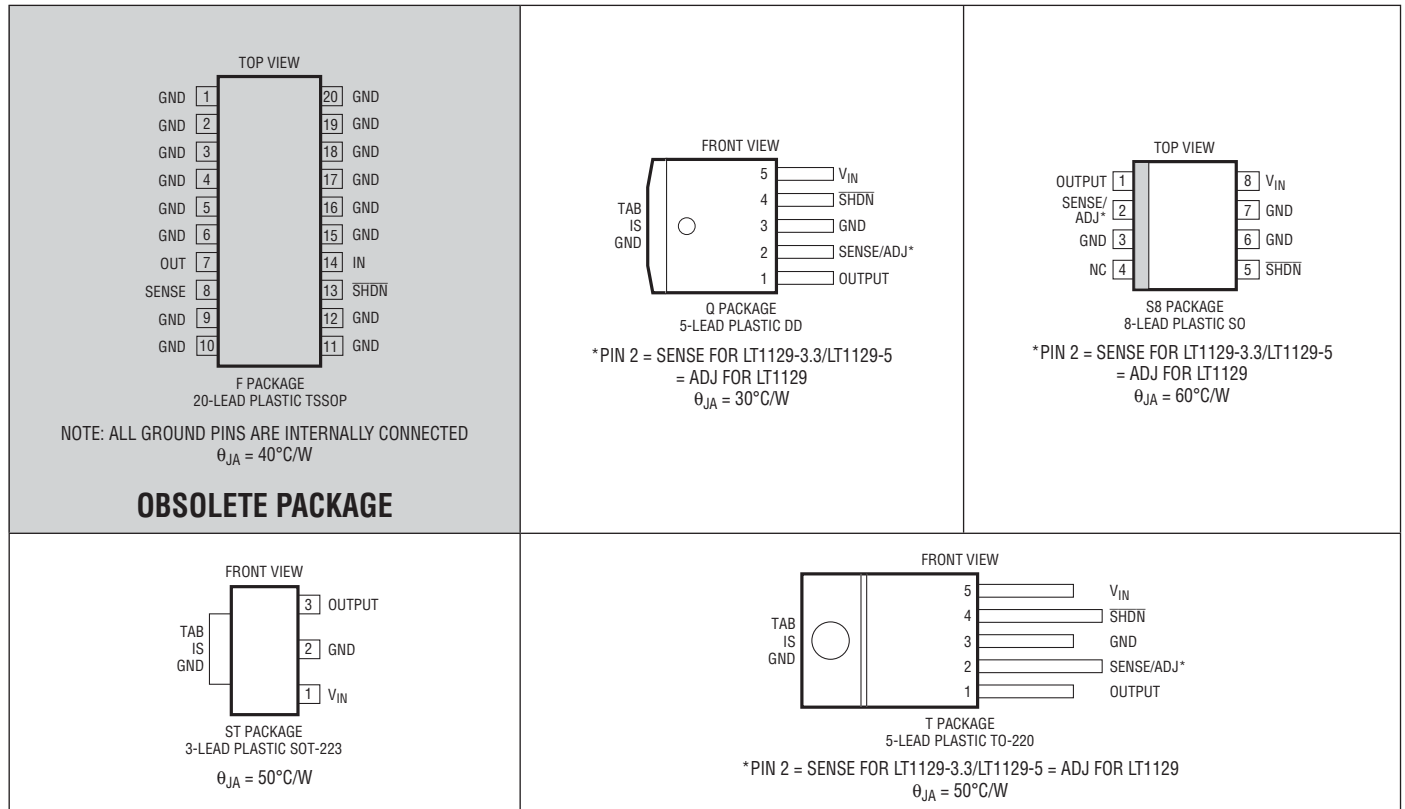

ORDER INFORMATION

| LEAD FREE FINISH | TAPE AND REEL | PART MARKING* | PACKAGE DESCRIPTION | TEMPERATURE RANGE |
|-------------------|---------------------|---------------|---------------------|--|
| LT1129CS8#PBF | LT1129CS8#TRPBF | 1129 | 8-Lead Plastic SO | 0°C to 125°C |
| LT1129IS8#PBF | LT1129IS8#TRPBF | 1129I | 8-Lead Plastic SO | -40°C to 125°C |
| LT1129CS8-3.3#PBF | LT1129CS8-3.3#TRPBF | 11293 | 8-Lead Plastic SO | 0°C to 125°C |
| LT1129IS8-3.3#PBF | LT1129IS8-3.3#TRPBF | 1129I3 | 8-Lead Plastic SO | -40°C to 125°C |
| LT1129CS8-5#PBF | LT1129CS8-5#TRPBF | 11295 | 8-Lead Plastic SO | 0°C to 125°C |

112935ff

ORDER INFORMATION

| LEAD FREE FINISH | TAPE AND REEL | PART MARKING* | PACKAGE DESCRIPTION | TEMPERATURE RANGE |
|--------------------|----------------------|---------------|------------------------|-------------------|
| LT1129IS8-5#PBF | LT1129IS8-5#TRPBF | 1129I5 | 8-Lead Plastic SO | -40°C to 125°C |
| LT1129CST-3.3#PBF | LT1129CST-3.3#TRPBF | 11293 | 3-Lead Plastic SOT-223 | 0°C to 125°C |
| LT1129IST-3.3#PBF | LT1129IST-3.3#TRPBF | 129I3 | 3-Lead Plastic SOT-223 | -40°C to 125°C |
| LT1129MPST-3.3#PBF | LT1129MPST-3.3#TRPBF | 129MP3 | 3-Lead Plastic SOT-223 | -55°C to 125°C |
| LT1129CST-5#PBF | LT1129CST-5#TRPBF | 11295 | 3-Lead Plastic SOT-223 | 0°C to 125°C |
| LT1129IST-5#PBF | LT1129IST-5#TRPBF | 129I5 | 3-Lead Plastic SOT-223 | -40°C to 125°C |
| LT1129CQ#PBF | LT1129CQ#TRPBF | LT1129CQ | 5-Lead Plastic DD-PAK | 0°C to 125°C |
| LT1129IQ#PBF | LT1129IQ#TRPBF | LT1129IQ | 5-Lead Plastic DD-PAK | -40°C to 125°C |
| LT1129CQ-3.3#PBF | LT1129CQ-3.3#TRPBF | LT1129CQ-3.3 | 5-Lead Plastic DD-PAK | 0°C to 125°C |
| LT1129IQ-3.3#PBF | LT1129IQ-3.3#TRPBF | LT1129IQ-3.3 | 5-Lead Plastic DD-PAK | -40°C to 125°C |
| LT1129CQ-5#PBF | LT1129CQ-5#TRPBF | LT1129CQ-5 | 5-Lead Plastic DD-PAK | 0°C to 125°C |
| LT1129IQ-5#PBF | LT1129IQ-5#TRPBF | LT1129IQ-5 | 5-Lead Plastic DD-PAK | -40°C to 125°C |
| LT1129CT#PBF | LT1129CT#TRPBF | LT1129CT | 5-Lead Plastic TO-220 | 0°C to 125°C |
| LT1129IT#PBF | LT1129IT#TRPBF | LT1129IT | 5-Lead Plastic TO-220 | -40°C to 125°C |
| LT1129CT-3.3#PBF | LT1129CT-3.3#TRPBF | LT1129CT-3.3 | 5-Lead Plastic TO-220 | 0°C to 125°C |
| LT1129IT-3.3#PBF | LT1129IT-3.3#TRPBF | LT1129IT-3.3 | 5-Lead Plastic TO-220 | -40°C to 125°C |
| LT1129CT-5#PBF | LT1129CT-5#TRPBF | LT1129CT-5 | 5-Lead Plastic TO-220 | 0°C to 125°C |
| LT1129IT-5#PBF | LT1129IT-5#TRPBF | LT1129IT-5 | 5-Lead Plastic TO-220 | -40°C to 125°C |
| LEAD BASED FINISH | TAPE AND REEL | PART MARKING* | PACKAGE DESCRIPTION | TEMPERATURE RANGE |
| LT1129CS8 | LT1129CS8#TR | 1129 | 8-Lead Plastic SO | 0°C to 125°C |
| LT1129IS8 | LT1129IS8#TR | 1129I | 8-Lead Plastic SO | -40°C to 125°C |
| LT1129CS8-3.3 | LT1129CS8-3.3#TR | 11293 | 8-Lead Plastic SO | 0°C to 125°C |
| LT1129IS8-3.3 | LT1129IS8-3.3#TR | 1129I3 | 8-Lead Plastic SO | -40°C to 125°C |
| LT1129CS8-5 | LT1129CS8-5#TR | 11295 | 8-Lead Plastic SO | 0°C to 125°C |
| LT1129IS8-5 | LT1129IS8-5#TR | 1129I5 | 8-Lead Plastic SO | -40°C to 125°C |
| LT1129CST-3.3 | LT1129CST-3.3#TR | 11293 | 3-Lead Plastic SOT-223 | 0°C to 125°C |
| LT1129IST-3.3 | LT1129IST-3.3#TR | 129I3 | 3-Lead Plastic SOT-223 | -40°C to 125°C |
| LT1129MPST-3.3 | LT1129MPST-3.3#TR | 129MP3 | 3-Lead Plastic SOT-223 | -55°C to 125°C |
| LT1129CST-5 | LT1129CST-5#TR | 11295 | 3-Lead Plastic SOT-223 | 0°C to 125°C |
| LT1129IST-5 | LT1129IST-5#TR | 129I5 | 3-Lead Plastic SOT-223 | -40°C to 125°C |
| LT1129CQ | LT1129CQ#TR | LT1129CQ | 5-Lead Plastic DD-PAK | 0°C to 125°C |
| LT1129IQ | LT1129IQ#TR | LT1129IQ | 5-Lead Plastic DD-PAK | -40°C to 125°C |
| LT1129CQ-3.3 | LT1129CQ-3.3#TR | LT1129CQ-3.3 | 5-Lead Plastic DD-PAK | 0°C to 125°C |
| LT1129IQ-3.3 | LT1129IQ-3.3#TR | LT1129IQ-3.3 | 5-Lead Plastic DD-PAK | -40°C to 125°C |
| LT1129CQ-5 | LT1129CQ-5#TR | LT1129CQ-5 | 5-Lead Plastic DD-PAK | 0°C to 125°C |
| LT1129IQ-5 | LT1129IQ-5#TR | LT1129IQ-5 | 5-Lead Plastic DD-PAK | -40°C to 125°C |
| LT1129CT | LT1129CT#TR | LT1129CT | 5-Lead Plastic TO-220 | 0°C to 125°C |
| LT1129IT | LT1129IT#TR | LT1129IT | 5-Lead Plastic TO-220 | -40°C to 125°C |
| LT1129CT-3.3 | LT1129CT-3.3#TR | LT1129CT-3.3 | 5-Lead Plastic TO-220 | 0°C to 125°C |
| LT1129IT-3.3 | LT1129IT-3.3#TR | LT1129IT-3.3 | 5-Lead Plastic TO-220 | -40°C to 125°C |

112935ff

LT1129/LT1129-3.3/LT1129-5

ORDER INFORMATION

| LEAD BASED FINISH | TAPE AND REEL | PART MARKING* | PACKAGE DESCRIPTION | TEMPERATURE RANGE |
|-------------------|---------------|---------------|-----------------------|-------------------|
| LT1129CT-5 | LT1129CT-5#TR | LT1129CT-5 | 5-Lead Plastic TO-220 | 0°C to 125°C |
| LT1129IT-5 | LT1129IT-5#TR | LT1129IT-5 | 5-Lead Plastic TO-220 | -40°C to 125°C |

Consult LTC Marketing for parts specified with wider operating temperature ranges. *The temperature grade is identified by a label on the shipping container.

For more information on lead free part marking, go to: <http://www.linear.com/leadfree/>

For more information on tape and reel specifications, go to: <http://www.linear.com/tapeandreel/>

ELECTRICAL CHARACTERISTICS

The ● denotes the specifications which apply over the full operating temperature range, otherwise specifications are at $T_A = 25^\circ\text{C}$.

| SYMBOL | CONDITIONS | | MIN | TYP | MAX | UNITS | |
|--|---|---|------|----------------|----------------|----------------|----------|
| Regulated Output Voltage (Notes 4, 12) | LT1129-3.3 | $V_{IN} = 3.8\text{V}$, $I_{OUT} = 1\text{mA}$, $T_J = 25^\circ\text{C}$ $4.3\text{V} < V_{IN} < 20\text{V}$, $1\text{mA} < I_{OUT} < 700\text{mA}$ | ● | 3.250 3.200 | 3.300 3.300 | 3.350 3.400 | V V |
| | LT1129-5 | $V_{IN} = 5.5\text{V}$, $I_{OUT} = 1\text{mA}$, $T_J = 25^\circ\text{C}$ $6\text{V} < V_{IN} < 20\text{V}$, $1\text{mA} < I_{OUT} < 700\text{mA}$ | ● | 4.925 4.850 | 5.000 5.000 | 5.075 5.150 | V V |
| | LT1129 (Note 5) | $V_{IN} = 4.3\text{V}$, $I_{OUT} = 1\text{mA}$, $T_J = 25^\circ\text{C}$ $4.8\text{V} < V_{IN} < 20\text{V}$, $1\text{mA} < I_{OUT} < 700\text{mA}$ | ● | 3.695 3.640 | 3.750 3.750 | 3.805 3.860 | V V |
| Line Regulation (Note 12) | LT1129-3.3 | $\Delta V_{IN} = 4.8\text{V}$ to 20V, $I_{OUT} = 1\text{mA}$ | ● | | 1.5 | 10 | mV |
| | LT1129-5 | $\Delta V_{IN} = 5.5\text{V}$ to 20V, $I_{OUT} = 1\text{mA}$ | ● | | 1.5 | 10 | mV |
| | LT1129 (Note 5) | $\Delta V_{IN} = 4.3\text{V}$ to 20V, $I_{OUT} = 1\text{mA}$ | ● | | 1.5 | 10 | mV |
| Load Regulation (Note 12) | LT1129-3.3 | $\Delta I_{LOAD} = 1\text{mA}$ to 700mA, $T_J = 25^\circ\text{C}$ $\Delta I_{LOAD} = 1\text{mA}$ to 700mA | ● | | 6 15 | 20 30 | mV mV |
| | LT1129-5 | $\Delta I_{LOAD} = 1\text{mA}$ to 700mA, $T_J = 25^\circ\text{C}$ $\Delta I_{LOAD} = 1\text{mA}$ to 700mA | ● | | 6 20 | 20 30 | mV mV |
| | LT1129 (Note 5) | $\Delta I_{LOAD} = 1\text{mA}$ to 700mA, $T_J = 25^\circ\text{C}$ $\Delta I_{LOAD} = 1\text{mA}$ to 700mA | ● | | 6 15 | 20 30 | mV mV |
| Dropout Voltage (Note 6) | $I_{LOAD} = 10\text{mA}$, $T_J = 25^\circ\text{C}$ $I_{LOAD} = 10\text{mA}$ | ● | | 0.13 | 0.20 0.25 | V V | |
| | $I_{LOAD} = 100\text{mA}$, $T_J = 25^\circ\text{C}$ $I_{LOAD} = 100\text{mA}$ | ● | | 0.25 | 0.35 0.45 | V V | |
| | $I_{LOAD} = 500\text{mA}$, $T_J = 25^\circ\text{C}$ $I_{LOAD} = 500\text{mA}$ | ● | | 0.37 | 0.45 0.60 | V V | |
| | $I_{LOAD} = 700\text{mA}$, $T_J = 25^\circ\text{C}$ $I_{LOAD} = 700\text{mA}$ | ● | | 0.45 | 0.55 0.70 | V V | |
| Ground Pin Current (Note 7) | $I_{LOAD} = 0\text{mA}$ | ● | | 50 | 70 | μA | |
| | $I_{LOAD} = 10\text{mA}$ | ● | | 310 | 450 | μA | |
| | $I_{LOAD} = 100\text{mA}$ | ● | | 2.0 | 3.5 | mA | |
| | $I_{LOAD} = 300\text{mA}$ | ● | | 10 | 20 | mA | |
| | $I_{LOAD} = 500\text{mA}$ | ● | | 25 | 45 | mA | |
| | $I_{LOAD} = 700\text{mA}$ | ● | | 50 | 90 | mA | |
| Adjust Pin Bias Current (Notes 5, 8) | $T_J = 25^\circ\text{C}$ | | | 150 | 300 | nA | |
| Shutdown Threshold | $V_{OUT} = \text{Off to On}$ | ● | | 1.2 | 2.8 | V | |
| | $V_{OUT} = \text{On to Off}$ | ● | 0.25 | 0.75 | | V | |
| Shutdown Pin Current (Note 9) | $V_{SHDN} = 0\text{V}$ | ● | | 6 | 10 | μA | |
| Quiescent Current in Shutdown (Note 10) | $V_{IN} = 6\text{V}$, $V_{SHDN} = 0\text{V}$ | ● | | 15 | 25 | μA | |

112935ff

ELECTRICAL CHARACTERISTICS The ● denotes the specifications which apply over the full operating temperature range, otherwise specifications are at $T_A = 25^\circ\text{C}$.

| SYMBOL | CONDITIONS | MIN | TYP | MAX | UNITS |
|----------------------------------|--|-----|-----|-----|---------------|
| Ripple Rejection | $V_{IN} - V_{OUT} = 1\text{V (Avg)}$, $V_{RIPPLE} = 0.5\text{V}_{P-P}$, $f_{RIPPLE} = 120\text{Hz}$, $I_{LOAD} = 0.7\text{A}$, $T_J = 25^\circ\text{C}$ | 52 | 64 | | dB |
| Current Limit | $V_{IN} - V_{OUT} = 7\text{V}$, $T_J = 25^\circ\text{C}$ | | 1.2 | 1.6 | A |
| Input Reverse Leakage Current | $V_{IN} = -20\text{V}$, $V_{OUT} = 0\text{V}$ | ● | | 1.0 | mA |
| Reverse Output Current (Note 11) | LT1129-3.3 $V_{OUT} = 3.3\text{V}$, $V_{IN} = 0\text{V}$ LT1129-5 $V_{OUT} = 5\text{V}$, $V_{IN} = 0\text{V}$ LT1129 (Note 5) $V_{OUT} = 3.8\text{V}$, $V_{IN} = 0\text{V}$ | | 16 | 25 | μA |
| | | | 16 | 25 | μA |
| | | | 16 | 25 | μA |

Note 1: Stresses beyond those listed under Absolute Maximum Ratings may cause permanent damage to the device. Exposure to any Absolute Maximum Rating condition for extended periods may affect device reliability and lifetime.

Note 2: The shutdown pin input voltage rating is required for a low impedance source. Internal protection devices connected to the shutdown pin will turn on and clamp the pin to approximately 7V or -0.6V. This range allows the use of 5V logic devices to drive the pin directly. For high impedance sources or logic running on supply voltages greater than 5.5V, the maximum current driven into the shutdown pin must be limited to less than 20mA.

Note 3: For junction temperatures greater than 110°C, a minimum load of 1mA is recommended. For $T_J > 110^\circ\text{C}$ and $I_{OUT} < 1\text{mA}$, output voltage may increase by 1%.

Note 4: Operating conditions are limited by maximum junction temperature. The regulated output voltage specification will not apply for all possible combinations of input voltage and output current. When operating at maximum input voltage, the output current range must be limited. When operating at maximum output current, the input voltage range must be limited.

Note 5: The LT1129 is tested and specified with the adjust pin connected to the output pin.

Note 6: Dropout voltage is the minimum input/output voltage required to maintain regulation at the specified output current. In dropout the output

voltage will be equal to $(V_{IN} - V_{DROPOUT})$. Dropout voltage is measured between the input pin and the output pin. External voltage drops between the output pin and the sense pin will add to the dropout voltage.

Note 7: Ground pin current is tested with $V_{IN} = V_{OUT}$ (nominal) and a current source load. This means that the device is tested while operating in its dropout region. This is the worst case ground pin current. The ground pin current will decrease slightly at higher input voltages.

Note 8: Adjust pin bias current flows into the adjust pin.

Note 9: Shutdown pin current at $V_{SHDN} = 0\text{V}$ flows out of the shutdown pin.

Note 10: Quiescent current in shutdown is equal to the sum total of the shutdown pin current (6 μA) and the ground pin current (9 μA).

Note 11: Reverse output current is tested with the input pin grounded. The output pin and the sense pin are forced to the rated output voltage. This current flows into the sense pin and out of the ground pin. For the LT1129 (adjustable version) the sense pin is internally tied to the output pin.

Note 12: The LT1129 regulators are tested and specified under pulse load conditions such that $T_J \cong T_A$. The LT1129C regulators are 100% tested at $T_A = 25^\circ\text{C}$. For C-grade devices, Regulated Output Voltage, Line Regulation and Load Regulation performance at -40°C and 125°C is assured by design, characterization and correlation with statistical process controls. The LT1129I regulators are guaranteed over the full -40°C to 125°C operating junction temperature range. The LT1129MP regulators are 100% tested and guaranteed over the -55°C to 125°C temperature range.

TYPICAL PERFORMANCE CHARACTERISTICS

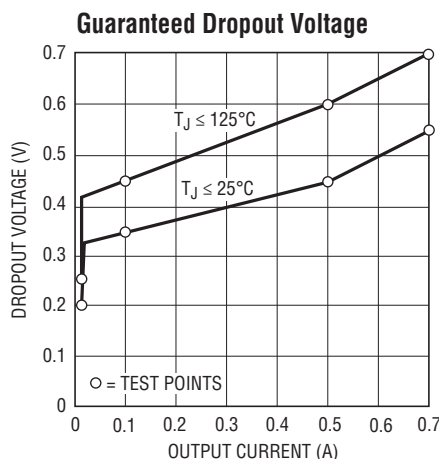

112935 G01

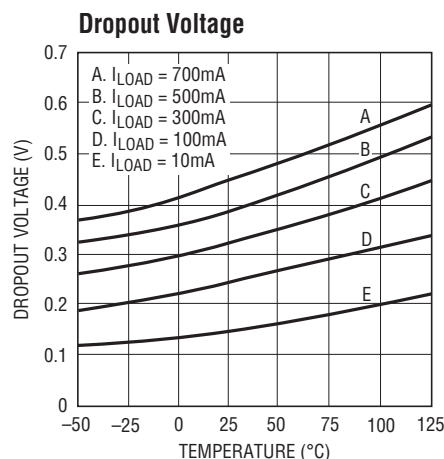

112935 G02

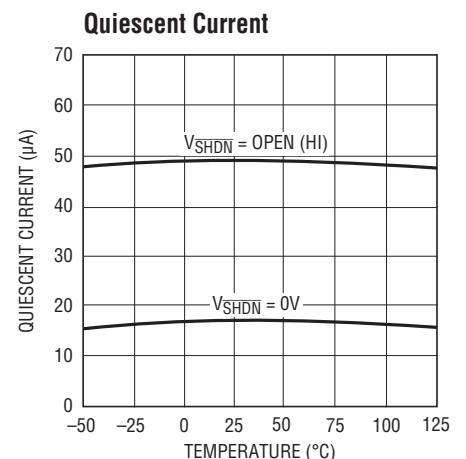

112935 G03
112935ff

TYPICAL PERFORMANCE CHARACTERISTICS

LT1129-3.3
Quiescent Current

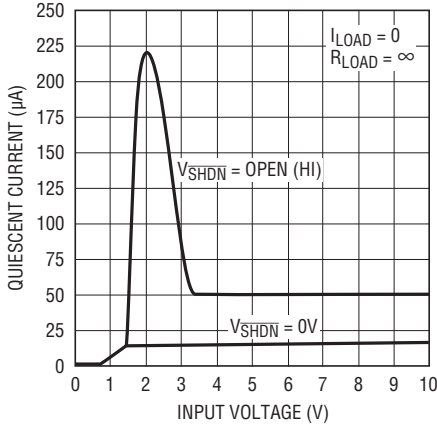

112935 G04

LT1129-5
Quiescent Current

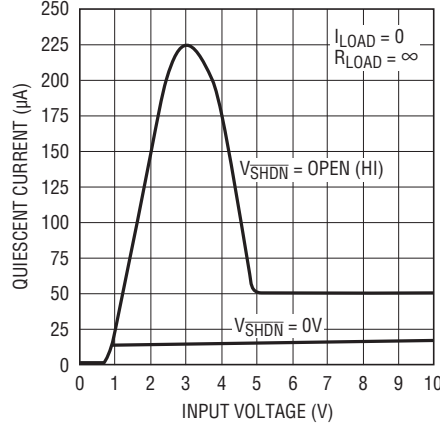

112935 G05

LT1129
Quiescent Current

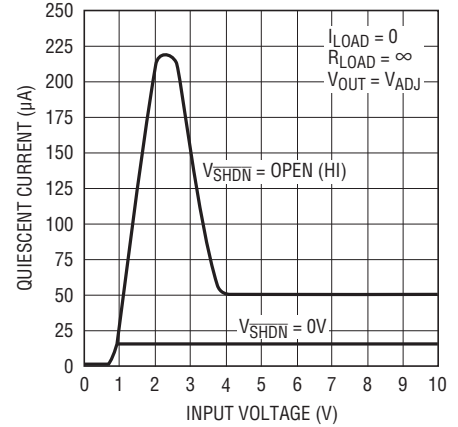

112935 G06

LT1129-3.3
Output Voltage

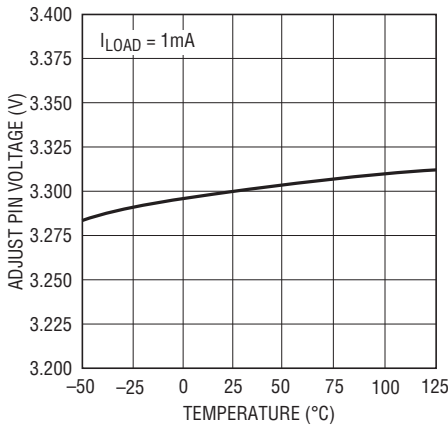

112935 G07

LT1129-5
Output Voltage

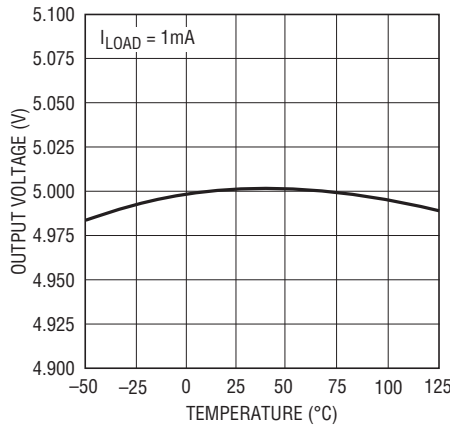

112935 G08

LT1129
Adjust Pin Voltage

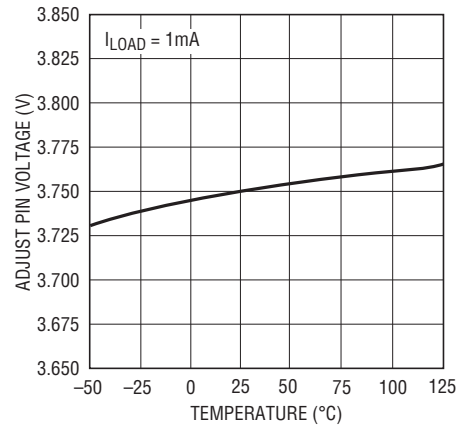

112935 G09

LT1129-3.3
Ground Pin Current

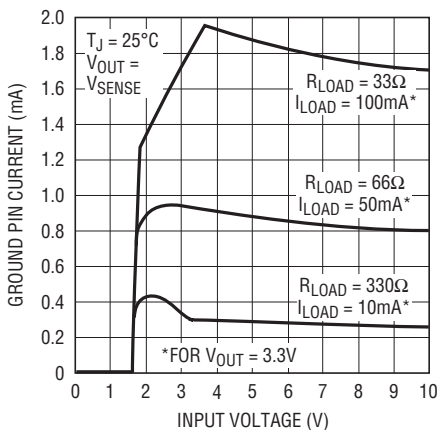

112935 G10

LT1129-5
Ground Pin Current

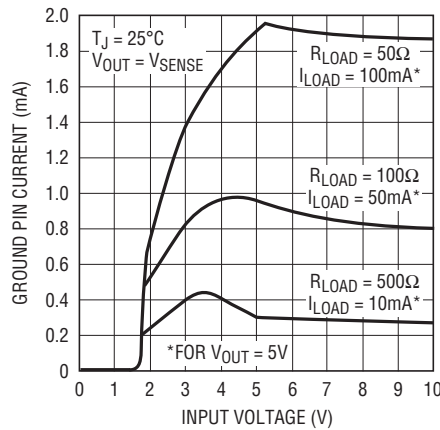

112935 G11

LT1129
Ground Pin Current

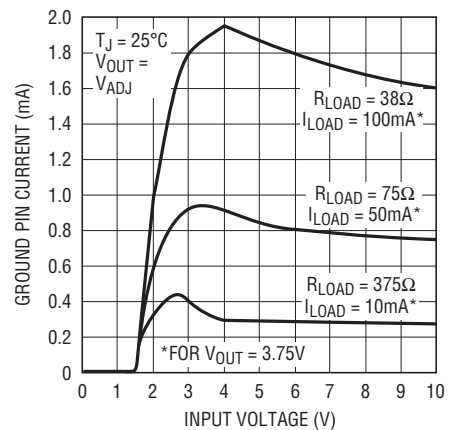

112935 G12

TYPICAL PERFORMANCE CHARACTERISTICS

**LT1129-3.3
Ground Pin Current**

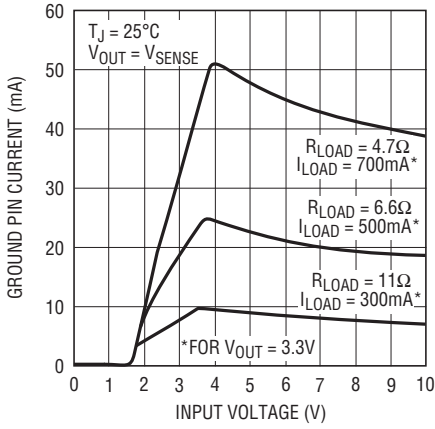

112935 G13

**LT1129-5
Ground Pin Current**

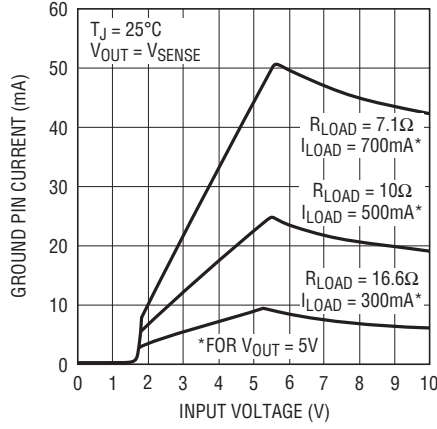

112935 G14

**LT1129
Ground Pin Current**

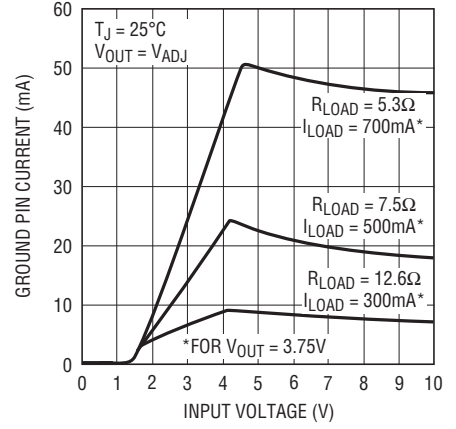

112935 G15

Ground Pin Current

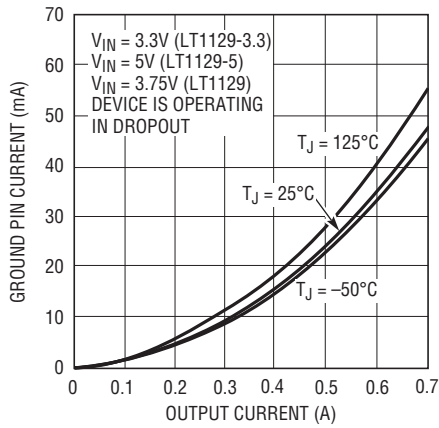

112935 G16

**Shutdown Pin Threshold
(On-to-Off)**

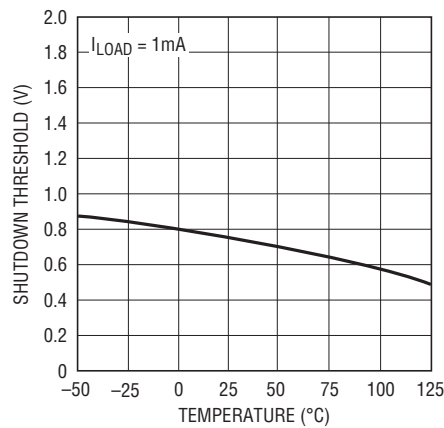

112935 G17

**Shutdown Pin Threshold
(Off-to-On)**

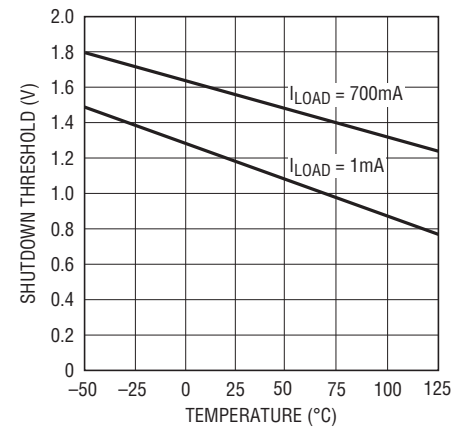

112935 G18

Shutdown Pin Current

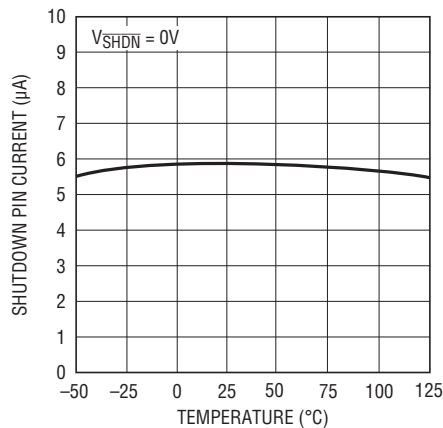

112935 G19

Shutdown Pin Input Current

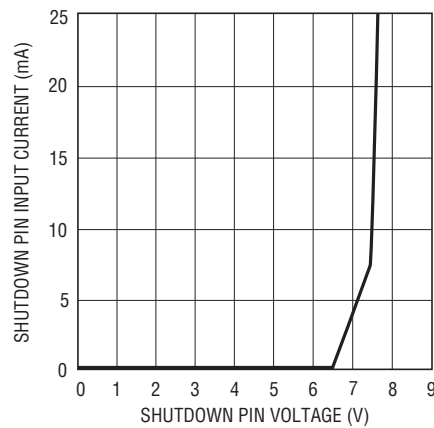

112935 G20

Adjust Pin Bias Current

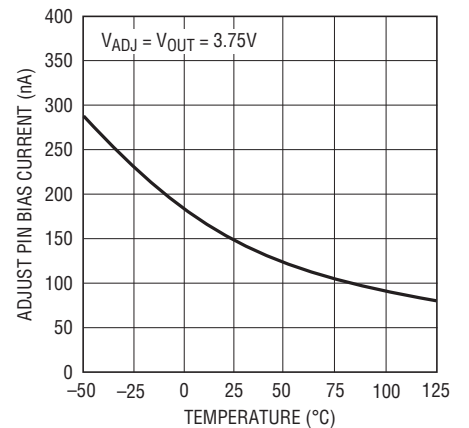

112935 G21

TYPICAL PERFORMANCE CHARACTERISTICS

Reverse Output Current

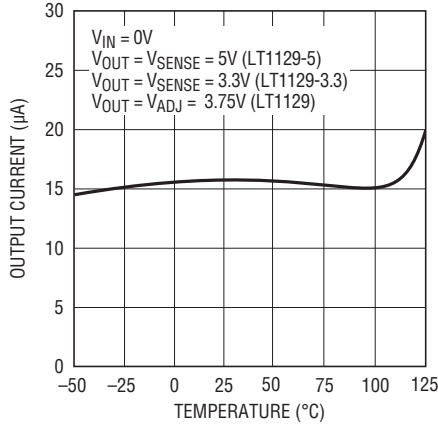

112935 G22

Current Limit

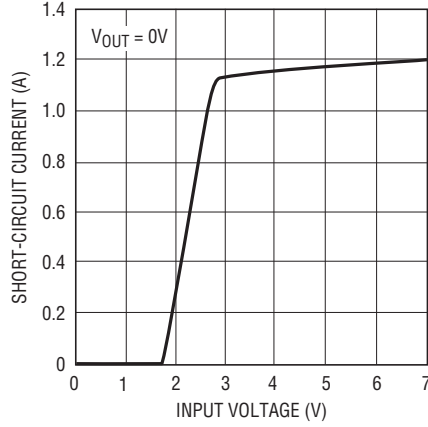

112935 G23

Current Limit

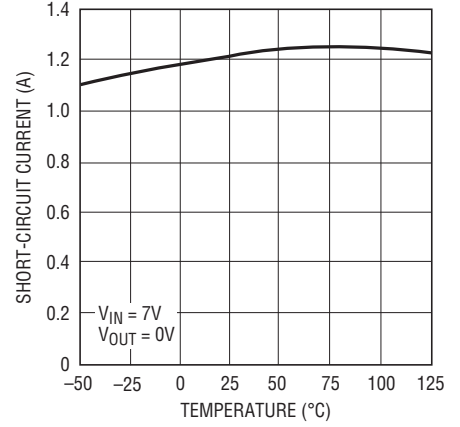

112935 G24

Reverse Output Current

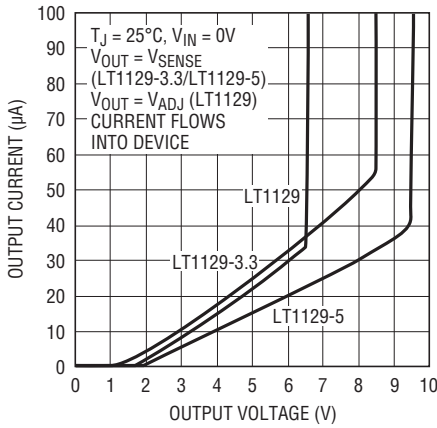

112935 G25

Ripple Rejection

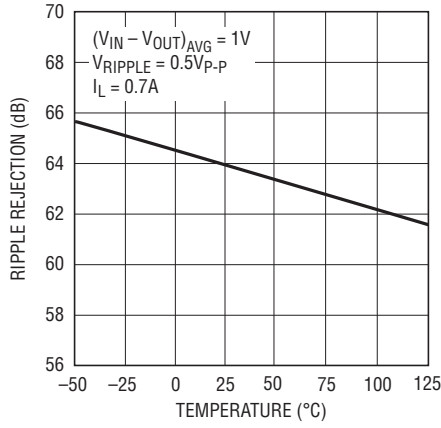

112935 G26

Ripple Rejection

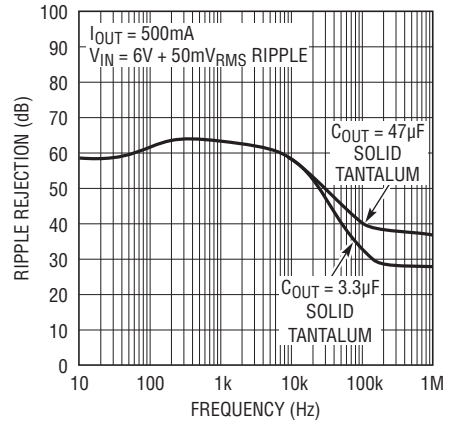

112935 G27

Load Regulation

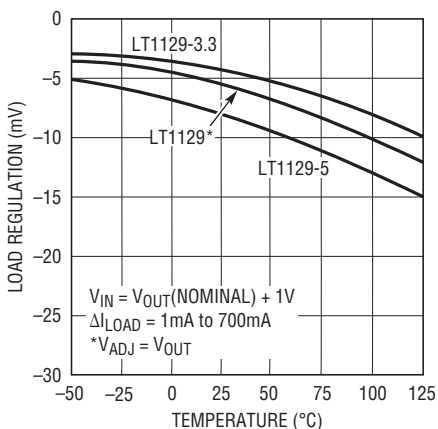

112935 G28

LT1129-5 Transient Response

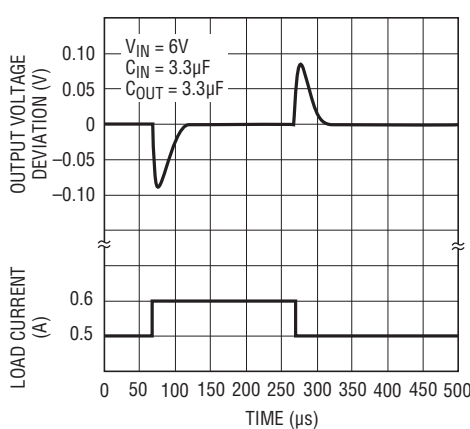

112935 G29

LT1129-5 Transient Response

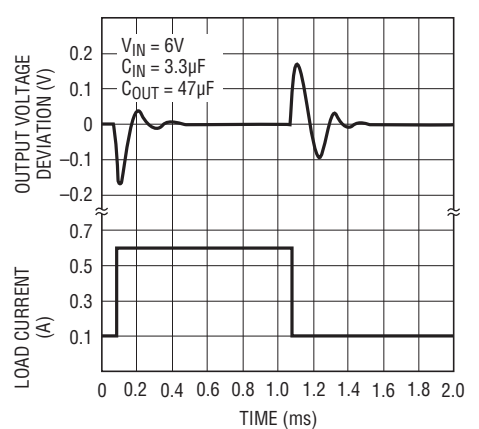

112935 G30

PIN FUNCTIONS

Input Pin: Power is supplied to the device through the input pin. The input pin should be bypassed to ground if the device is more than 6 inches away from the main input filter capacitor. In general, the output impedance of a battery rises with frequency so it is advisable to include a bypass capacitor in battery-powered circuits. A bypass capacitor in the range of $1\mu\text{F}$ to $10\mu\text{F}$ is sufficient. The LT1129 is designed to withstand reverse voltages on the input pin with respect to both ground and the output pin. In the case of a reversed input, which can happen if a battery is plugged in backwards, the LT1129 will act as if there is a diode in series with its input. There will be no reverse current flow into the LT1129 and no reverse voltage will appear at the load. The device will protect both itself and the load.

Output Pin: The output pin supplies power to the load. An output capacitor is required to prevent oscillations. See the Applications Information section for recommended value of output capacitance and information on reverse output characteristics.

Shutdown Pin ($\overline{\text{SHDN}}$): This pin is used to put the device into shutdown. In shutdown the output of the device is turned off. This pin is active low. The device will be shut down if the shutdown pin is actively pulled low. The shutdown pin current with the pin pulled to ground will be $6\mu\text{A}$. The shutdown pin is internally clamped to 7V and -0.6V (one V_{BE}). This allows the shutdown pin to be driven directly by 5V logic or by open collector logic with a pull-up resistor. The pull-up resistor is only required to supply the leakage current of the open collector gate, normally several microamperes. Pull-up current must be limited to a maximum of 20mA . A curve of shutdown pin input current as a function of voltage appears in the Typical Performance Characteristics. If the shutdown pin is not

used it can be left open circuit. The device will be active, output on, if the shutdown pin is not connected.

Sense Pin: For fixed voltage versions of the LT1129 (LT1129-3.3, LT1129-5) the sense pin is the input to the error amplifier. Optimum regulation will be obtained at the point where the sense pin is connected to the output pin. For most applications the sense pin is connected directly to the output pin at the regulator. In critical applications small voltage drops caused by the resistance (R_{P}) of PC traces between the regulator and the load, which would normally degrade regulation, may be eliminated by connecting the sense pin to the output pin at the load as shown in Figure 1 (Kelvin Sense Connection). Note that the voltage drop across the external PC traces will add to the dropout voltage of the regulator. The sense pin bias current is $15\mu\text{A}$ at the nominal regulated output voltage. This pin is internally clamped to -0.6V (one V_{BE}).

Adjust Pin: For the LT1129 (adjustable version) the adjust pin is the input to the error amplifier. This pin is internally clamped to 6V and -0.6V (one V_{BE}). This pin has a bias current of 150nA which flows into the pin. See Bias Current curve in the Typical Performance Characteristics. The adjust pin reference voltage is equal to 3.75V referenced to ground.

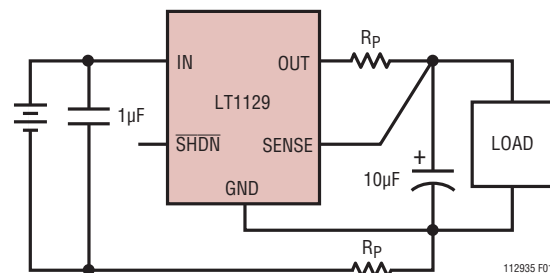

Figure 1. Kelvin Sense Connection

APPLICATIONS INFORMATION

The LT1129 is a micropower low dropout regulator with shutdown, capable of supplying 700mA of output current at a dropout voltage of 0.4V . The device operates with very low quiescent current ($50\mu\text{A}$). In shutdown the quiescent current drops to only $16\mu\text{A}$. In addition to the low quiescent current the LT1129 incorporates several protection

features which make it ideal for use in battery-powered systems. The device is protected against reverse input voltages. In battery backup applications where the output can be held up by a backup battery when the input is pulled to ground, the LT1129 acts like it has a diode in series with its output and prevents reverse current flow.

APPLICATIONS INFORMATION

Adjustable Operation

The adjustable version of the LT1129 has an output voltage range of 3.75V to 30V. The output voltage is set by the ratio of two external resistors as shown in Figure 2. The device servos the output voltage to maintain the voltage at the adjust pin at 3.75V. The current in R1 is then equal to $3.75V/R1$. The current in R2 is equal to the sum of the current in R1 and the adjust pin bias current. The adjust pin bias current, 150nA at 25°C, flows through R2 into the adjust pin. The output voltage can be calculated according to the formula in Figure 2. The value of R1 should be less than 400k to minimize errors in the output voltage caused by the adjust pin bias current. Note that in shutdown the output is turned off and the divider current will be zero. Curves of Adjust Pin Voltage vs Temperature and Adjust Pin Bias Current vs Temperature appear in the Typical Performance Characteristics. The reference voltage at the adjust pin has a positive temperature coefficient of approximately 15ppm/°C. The adjust pin bias current has a negative temperature coefficient. These effects are small and will tend to cancel each other.

The adjustable device is specified with the adjust pin tied to the output pin. This sets the output voltage to 3.75V. Specifications for output voltages greater than 3.75V will be proportional to the ratio of the desired output voltage to 3.75V ($V_{OUT}/3.75V$). For example: load regulation for an output current change of 1mA to 700mA is -6mV typical at $V_{OUT} = 3.75V$. At $V_{OUT} = 12V$, load regulation would be:

$$\left(\frac{12V}{3.75V} \right) \cdot (-6mV) = (-19mV)$$

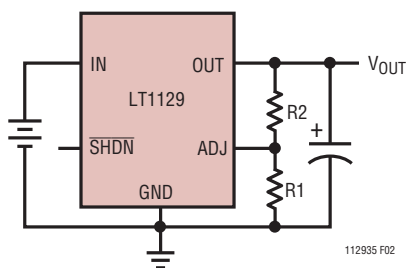

$$V_{OUT} = 3.75V \left(1 + \frac{R2}{R1} \right) + (I_{ADJ} \cdot R2)$$

$V_{ADJ} = 3.75V$
 $I_{ADJ} = 150nA$ at 25°C
 OUTPUT RANGE = 3.75V to 30V

Figure 2. Adjustable Operation

Thermal Considerations

The power handling capability of the device will be limited by the maximum rated junction temperature (125°C). The power dissipated by the device will be made up of two components:

1. Output current multiplied by the input/output voltage differential: $I_{OUT} \cdot (V_{IN} - V_{OUT})$, and
2. Ground pin current multiplied by the input voltage: $I_{GND} \cdot V_{IN}$.

The ground pin current can be found by examining the Ground Pin Current curves in the Typical Performance Characteristics. Power dissipation will be equal to the sum of the two components listed above.

The LT1129 series regulators have internal thermal limiting designed to protect the device during overload conditions. For continuous normal load conditions the maximum junction temperature rating of 125°C must not be exceeded. It is important to give careful consideration to all sources of thermal resistance from junction to ambient. Additional heat sources mounted nearby must also be considered.

For surface mount devices heat sinking is accomplished by using the heat spreading capabilities of the PC board and its copper traces. Experiments have shown that the heat spreading copper layer does not need to be electrically connected to the tab of the device. The PC material can be very effective at transmitting heat between the pad area, attached to the tab of the device, and a ground or power plane layer either inside or on the opposite side of the board. Although the actual thermal resistance of the PC material is high, the length/area ratio of the thermal resistor between layers is small. Copper board stiffeners and plated through holes can also be used to spread the heat generated by power devices.

The following tables list thermal resistances for each package. For the TO-220 package, thermal resistance is given for junction-to-case only since this package is usually mounted to a heat sink. Measured values of thermal resistance for several different board sizes and copper areas are listed for each package. All measurements were taken in still air on 3/32" FR-4 board with 1-oz

OPERATION

copper. This data can be used as a rough guideline in estimating thermal resistance. The thermal resistance for each application will be affected by thermal interactions with other components as well as board size and shape. Some experimentation will be necessary to determine the actual value.

Table 1. Q Package, 5-Lead DD

| COPPER AREA | | BOARD AREA | THERMAL RESISTANCE (JUNCTION-TO-AMBIENT) |
|-------------|-------------|-------------|--|
| TOPSIDE* | BACKSIDE | | |
| 2500 sq. mm | 2500 sq. mm | 2500 sq. mm | 25°C/W |
| 1000 sq. mm | 2500 sq. mm | 2500 sq. mm | 27°C/W |
| 125 sq. mm | 2500 sq. mm | 2500 sq. mm | 35°C/W |

* Tab of device attached to topside copper

Table 2. ST Package, 3-Lead SOT-223

| COPPER AREA | | BOARD AREA | THERMAL RESISTANCE (JUNCTION-TO-AMBIENT) |
|-------------|-------------|-------------|--|
| TOPSIDE* | BACKSIDE | | |
| 2500 sq. mm | 2500 sq. mm | 2500 sq. mm | 45°C/W |
| 1000 sq. mm | 2500 sq. mm | 2500 sq. mm | 45°C/W |
| 225 sq. mm | 2500 sq. mm | 2500 sq. mm | 53°C/W |
| 100 sq. mm | 2500 sq. mm | 2500 sq. mm | 59°C/W |

* Tab of device attached to topside copper

Table 3. S8 Package, 8-Lead Plastic SOIC

| COPPER AREA | | BOARD AREA | THERMAL RESISTANCE (JUNCTION-TO-AMBIENT) |
|-------------|-------------|-------------|--|
| TOPSIDE* | BACKSIDE | | |
| 2500 sq. mm | 2500 sq. mm | 2500 sq. mm | 55°C/W |
| 1000 sq. mm | 2500 sq. mm | 2500 sq. mm | 55°C/W |
| 225 sq. mm | 2500 sq. mm | 2500 sq. mm | 63°C/W |
| 100 sq. mm | 2500 sq. mm | 2500 sq. mm | 69°C/W |

* Device attached to topside copper

T Package, 5-Lead TO-220

Thermal Resistance (Junction-to-Case) = 5°C/W

Calculating Junction Temperature

Example: Given an output voltage of 3.3V, an input voltage range of 4.5V to 5.5V, an output current range of 0mA to 500mA, and a maximum ambient temperature of 50°C, what will the maximum junction temperature be?

The power dissipated by the device will be equal to:

$$I_{OUT\ MAX} \cdot (V_{IN\ MAX} - V_{OUT}) + (I_{GND} \cdot V_{IN\ MAX})$$

where, $I_{OUT\ MAX} = 500\text{mA}$

$$V_{IN\ MAX} = 5.5\text{V}$$

$$I_{GND} \text{ at } (I_{OUT} = 500\text{mA}, V_{IN} = 5.5\text{V}) = 25\text{mA}$$

$$\text{so, } P = 500\text{mA} \cdot (5.5\text{V} - 3.3\text{V}) + (25\text{mA} \cdot 5.5\text{V}) = 1.24\text{W}$$

If we use a DD package, then the thermal resistance will be in the range of 25°C/W to 35°C/W depending on copper area. So the junction temperature rise above ambient will be approximately equal to:

$$1.24\text{W} \cdot 30^\circ\text{C/W} = 37.2^\circ\text{C}$$

The maximum junction temperature will then be equal to the maximum junction temperature rise above ambient plus the maximum ambient temperature or:

$$T_{JMAX} = 50^\circ\text{C} + 37.2^\circ\text{C} = 87.2^\circ\text{C}$$

Output Capacitance and Transient Performance

The LT1129 is designed to be stable with a wide range of output capacitors. The minimum recommended value is 3.3µF with an ESR of 2Ω or less. The LT1129 is a micropower device and output transient response will be a function of output capacitance. See the Transient Response curves in the Typical Performance Characteristics. Larger values of output capacitance will decrease the peak deviations and provide improved output transient response. Bypass capacitors, used to decouple individual components powered by the LT1129, will increase the effective value of the output capacitor.

Protection Features

The LT1129 incorporates several protection features which make it ideal for use in battery-powered circuits. In addition to the normal protection features associated with monolithic regulators, such as current limiting and thermal limiting, the device is protected against reverse input voltages, and reverse voltages from output to input. For fixed voltage devices the output and sense pins are tied together at the output.

APPLICATIONS INFORMATION

Current limit protection and thermal overload protection are intended to protect the device against current overload conditions at the output of the device. For normal operation, the junction temperature should not exceed 125°C.

The input of the device will withstand reverse voltages of 30V. Current flow into the device will be limited to less than 1mA (typically less than 100µA) and no negative voltage will appear at the output. The device will protect both itself and the load. This provides protection against batteries that can be plugged in backwards.

For fixed voltage versions of the device, the sense pin is internally clamped to one diode drop below ground. For the adjustable version of the device, the output pin is internally clamped at one diode drop below ground. If the output pin of an adjustable device, or the sense pin of a fixed voltage device, is pulled below ground, with the input open or grounded, current must be limited to less than 5mA.

In circuits where a backup battery is required, several different input/output conditions can occur. The output voltage may be held up while the input is either pulled to ground, pulled to some intermediate voltage, or is left open circuit. Current flow back into the output will vary depending on the conditions. Many battery-powered circuits incorporate some form of power management. The following information will help optimize battery life. Table 4 summarizes the following information.

The reverse output current will follow the curve in Figure 3 when the input pin is pulled to ground. This current flows through the output pin to ground. The state of the shutdown pin will have no effect on output current when the input pin is pulled to ground.

In some applications it may be necessary to leave the input to the LT1129 unconnected when the output is held high. This can happen when the LT1129 is powered from a rectified AC source. If the AC source is removed, then the input of the LT1129 is effectively left floating. The reverse output current also follows the curve in Figure 3 if the input pin is left open. The state of the shutdown pin will have no effect on the reverse output current when the input pin is floating.

When the input of the LT1129 is forced to a voltage below its nominal output voltage and its output is held high, the reverse output current will still follow the curve shown in Figure 3. This can happen if the input of the LT1129 is connected to a discharged (low voltage) battery and the output is held up by either a backup battery or by a second regulator circuit.

When the input pin is forced below the output pin or the output pin is pulled above the input pin, the input current will typically drop to less than 2µA (see Figure 4). The state of the shutdown pin will have no effect on the reverse output current when the output is pulled above the input.

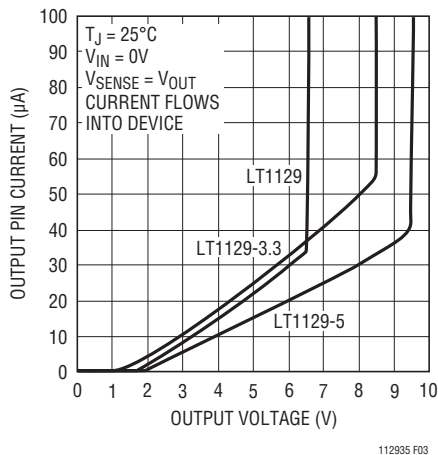

Figure 3. Reverse Output Current

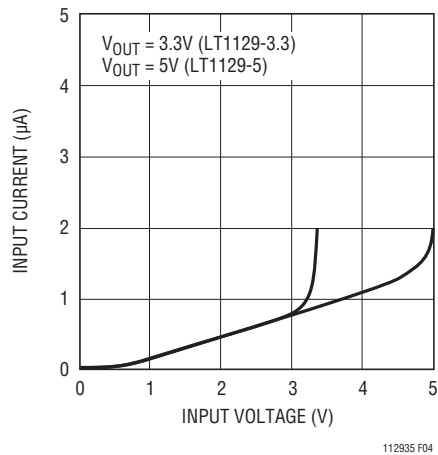

Figure 4. Input Current

APPLICATIONS INFORMATION

Table 4. Fault Conditions

| INPUT PIN | SHDN PIN | OUTPUT PIN | |
|-----------------------|-----------|-------------------------------|--|
| $< V_{OUT}$ (Nominal) | Open (Hi) | Forced to V_{OUT} (Nominal) | Reverse Output Current $\approx 15\mu\text{A}$ (See Figure 3) Input Current $\approx 1\mu\text{A}$ (See Figure 4) |
| $< V_{OUT}$ (Nominal) | Grounded | Forced to V_{OUT} (Nominal) | Reverse Output Current $\approx 15\mu\text{A}$ (See Figure 3) Input Current $\approx 1\mu\text{A}$ (See Figure 4) |
| Open | Open (Hi) | Forced to V_{OUT} (Nominal) | Reverse Output Current $\approx 15\mu\text{A}$ (See Figure 3) |
| Open | Grounded | Forced to V_{OUT} (Nominal) | Reverse Output Current $\approx 15\mu\text{A}$ (See Figure 3) |

PACKAGE DESCRIPTION

F Package
20-Lead Plastic TSSOP (4.4mm)
 (LTC DWG # 05-08-1650)

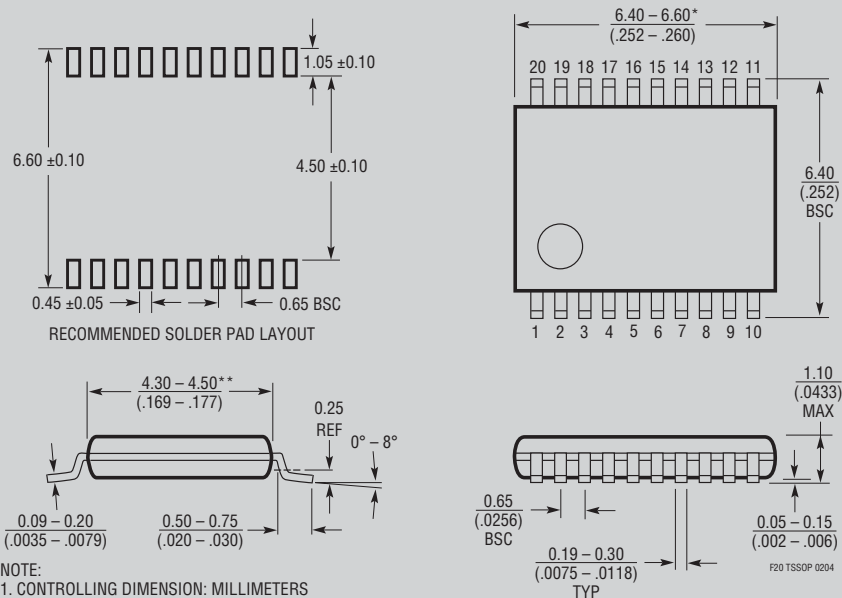

OBSOLETE PACKAGE

PACKAGE DESCRIPTION

Q Package
5-Lead Plastic DD Pak
 (LTC DWG # 05-08-1461)

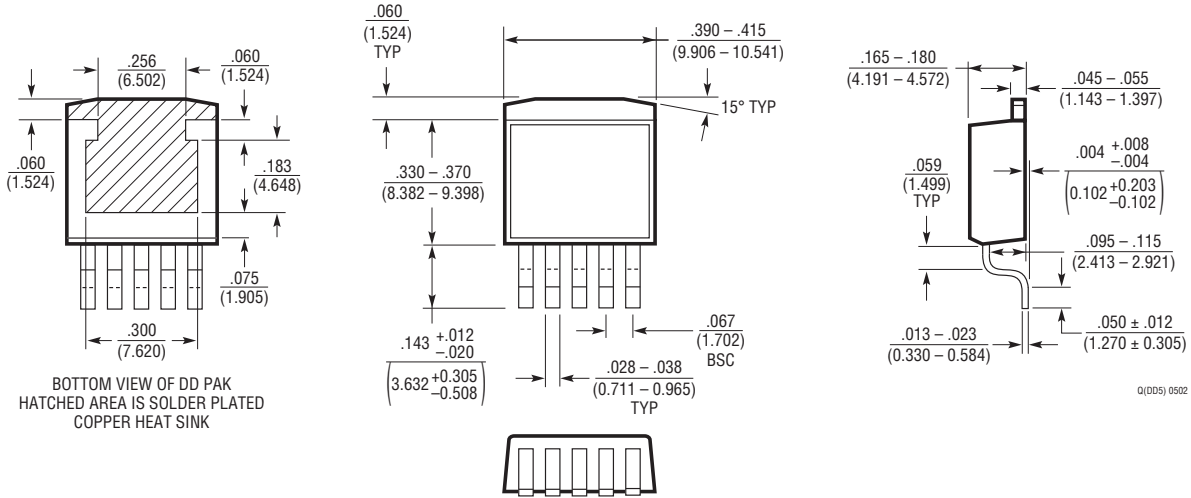

BOTTOM VIEW OF DD PAK
 HATCHED AREA IS SOLDER PLATED
 COPPER HEAT SINK

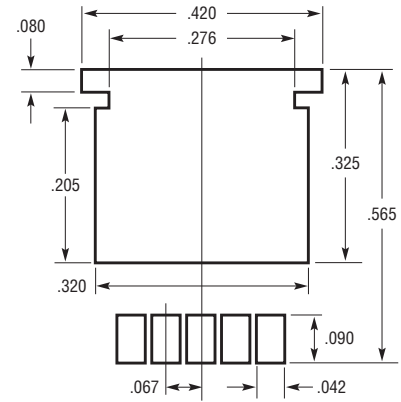
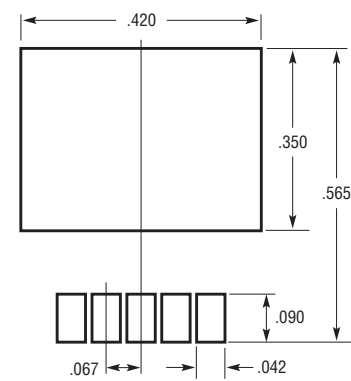

PACKAGE DESCRIPTION

S8 Package 8-Lead Plastic Small Outline (Narrow 0.150) (LTC DWG # 05-08-1610)

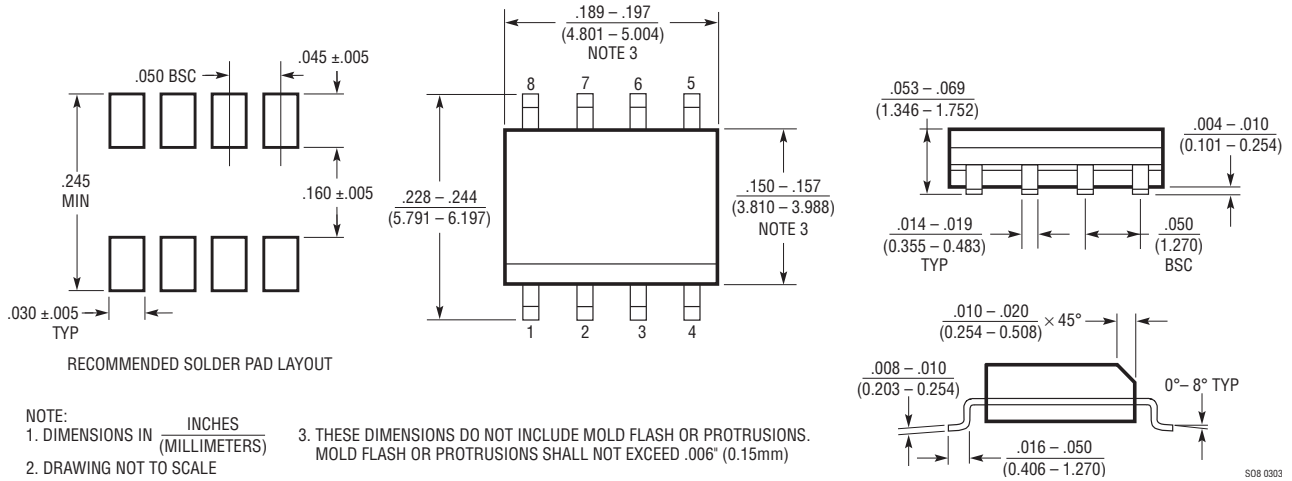

S08 0303

ST Package 3-Lead Plastic SOT-223 (LTC DWG # 05-08-1630)

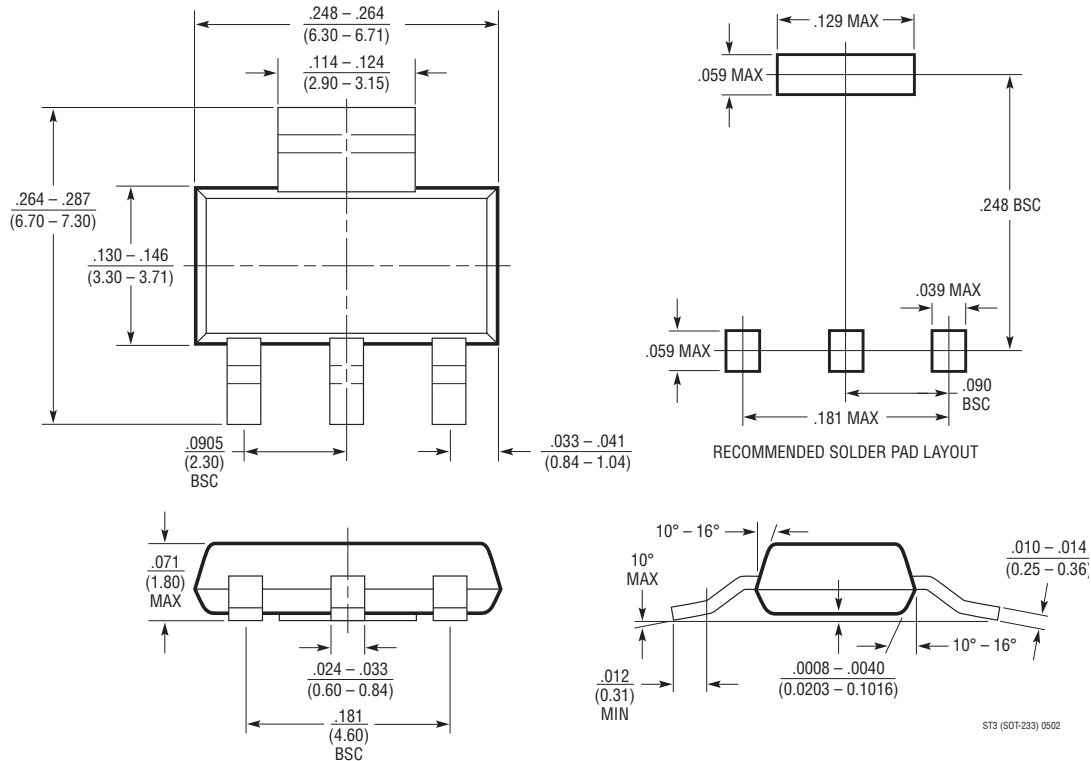

ST3 (SOT-223) 0502

TYPICAL APPLICATION

T Package
5-Lead Plastic TO-220 (Standard)
 (LTC DWG # 05-08-1421)

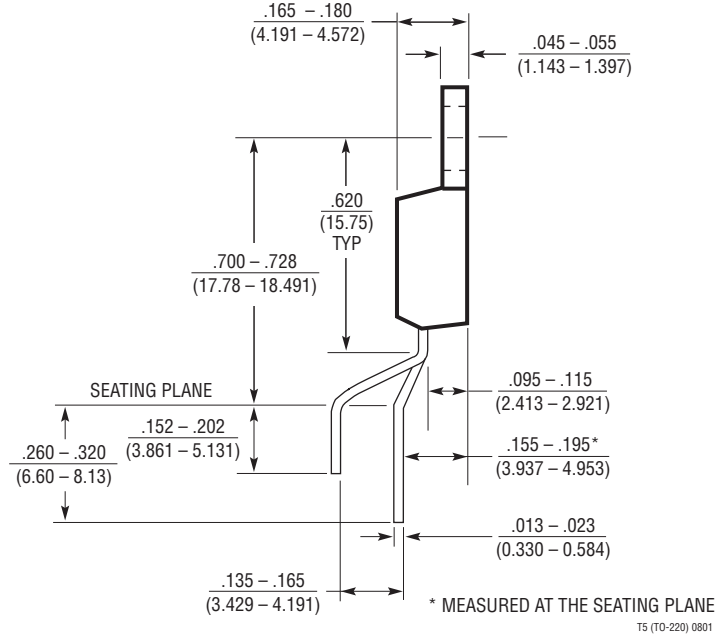
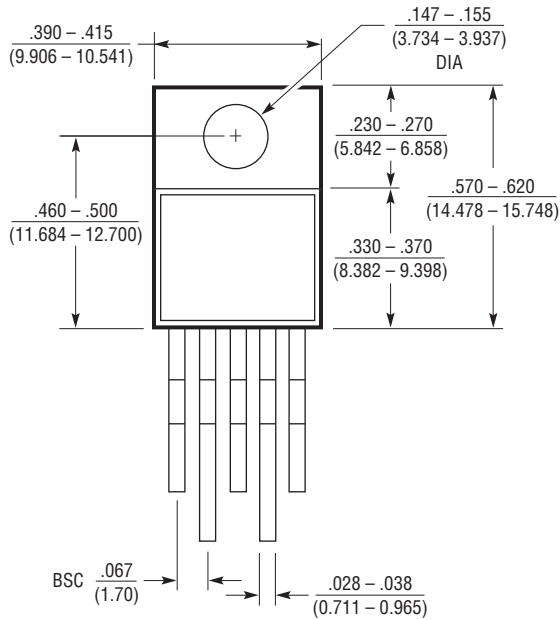

RELATED PARTS

| PART NUMBER | DESCRIPTION | COMMENTS |
|-------------|---|--|
| LT1121 | 150mA LDO Micropower Regulator | 30µA I _Q , SOT-223 Package |
| LT1761 | 100mA Low Noise, LDO Micropower Regulator | 20µA I _Q , 20µV _{RMS} Noise |
| LT1762 | 150mA Low Noise, LDO Micropower Regulator | 25µA I _Q , 20µV _{RMS} Noise |
| LT1962 | 300mA Low Noise, LDO Micropower Regulator | 30µA I _Q , 20µV _{RMS} Noise |
| LT1763 | 500mA Low Noise, LDO Micropower Regulator | 30µA I _Q , 20µV _{RMS} Noise |
| LT1963 | 1.5A Low Noise, Fast Transient, LDO Regulator | 340mV Dropout Voltage, 40µV _{RMS} Noise |
| LT1764 | 3A Low Noise, Fast Transient, LDO Regulator | 340mV Dropout Voltage, 40µV _{RMS} Noise |