

10G-KR Datasheet

10GBASE-KR/KR4 Compliance, Debug, and Decode Solution

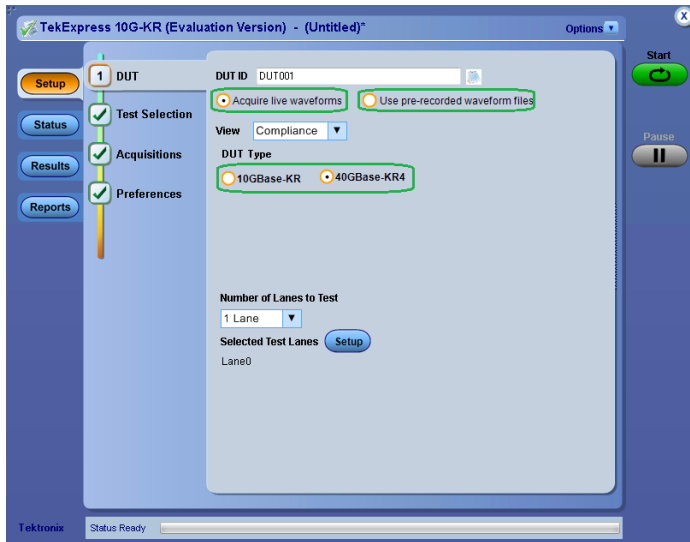

Features & Benefits

- Automates compliance measurements for IEEE 802.3ap-2007 specifications
- Includes both a TekExpress® automation solution (for compliance) and DPOJET (for debug)
- Automated test setup for measuring transmitter equalization levels generating 72 results, 12 results for each tap
- Approximately 15 minutes to generate 120 results for 9 different measurements
- Keithley RF switch support for four lanes of KR/KR4
- Signal acquisition and analysis support available using cost-effective SMA cables
- P7520 TriMode probe support for soldering to backplane KR directly
- Provision for entering filter files to de-embed the effects of backplane traces and any other components in the signal pathway
- Provides users with a Tektronix Floating License installation option
- Summary and detail test reports with margin and statistical information aid analysis
- Complete programmatic interface available; users can call 10G-KR functions using their automation scripts
- End-users can receive e-mail notification on measurement results and stay connected with their test setup
- Design engineers can utilize many built-in reporting features such as appending the report, auto-incrementing the report, including user comments, etc. to tailor their reporting requirements
- Performs automatic signal validation before performing tests and displays an error if the signal does not meet acceptable limits
- Provides protocol decode to disassemble 10G-KR 64b/66b traffic with time-correlated views of physical and protocol layer
- Works equally well on live setup and stored waveforms

Applications

Ethernet 10G-KR Transmitter Testing for:

- Device silicon validation
- System compliance and debug
- Manufacturing test

The Tektronix 10G-KR/KR4 Compliance, Debug, and Decode Solution software automates testing of 10GBASE-KR/KR4 10 Gigabit Ethernet Copper Backplane based on the IEEE 802.3ap specifications. The TekExpress framework allows design and validation engineers to configure their test setup, choose the measurements they want to run, and finally generate detailed test reports which help engineers make critical design and validation decisions. It also lets design engineers make use of the DPOJET jitter and analysis framework to debug their products. For design and validation engineers working on KR4, the 10G-KR solution provides an option to use Keithley RF switches and automates multiple-lane testing.

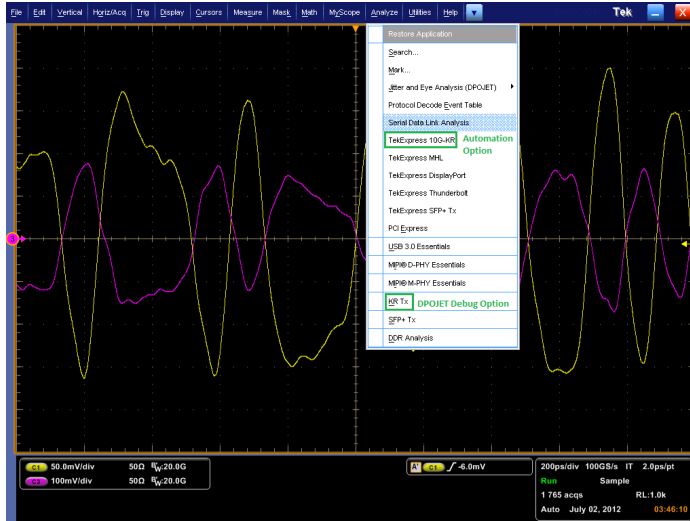

Option 10G-KR enables both an automation solution (for compliance) and DPOJET (for debug).

TekExpress 10G-KR Measurement Setup

The new 10G-KR solution helps engineers to easily select measurements for IEEE 802.3ap specification testing. Simple and easy-to-use measurement setup helps engineers perform all measurements with a single button click. Automation options help engineers meet their compliance needs and generate detailed reports. User-defined mode lets users make changes to the test limits and perform margin testing beyond compliance. User-defined mode enables flexible parameter control for characterization and margin analysis. The guided wizard prompts the user to send required patterns and calculate the measurements accordingly. The test report includes Pass/Fail summary, patterns used for testing, measured values of margins and limits, and waveforms and measurements used during the test process.



10G-KR DPOJET user interface.

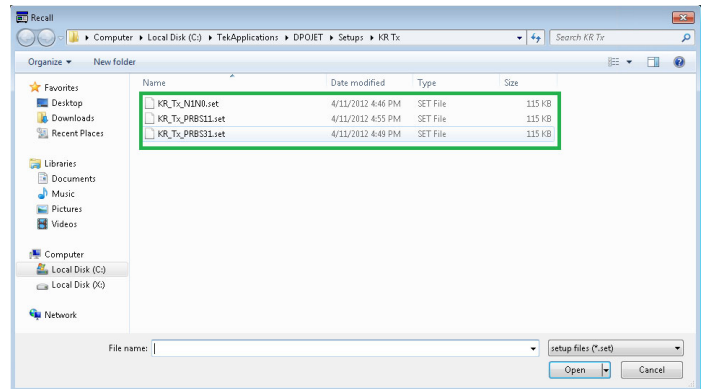

N1N0, PRBS11, and PRBS31-based measurement setup files.

DPOJET 10G-KR Measurement Setup

All limits and measurement parameters are automatically configured for the users. Additionally, design engineers have the flexibility to change selected measurements and measurement configurations within DPOJET. 10G-KR DPOJET options provide a new standard-specific UI. New additional measurements have been added including Rise Time, Fall Time, V_{p-p} , Jitter, Speed, Output Waveform Characteristics, etc. based on IEEE 802.3ap specifications. Setup files are provided based on different signal types such as N1N0, PRBS11, and PRBS31. Signal-specific setup files allow design engineers to perform measurements on different signal types, letting them go into Analysis and Debug mode.

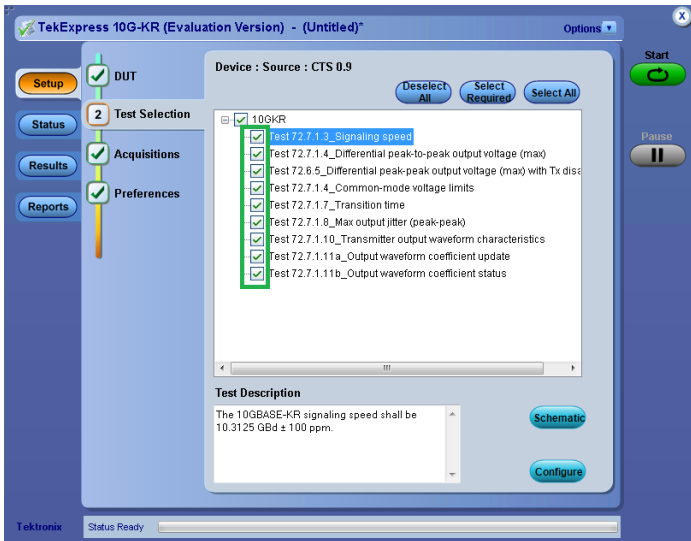

Details of the IEEE 802.3ap specification measurements covered in 10G-KR.

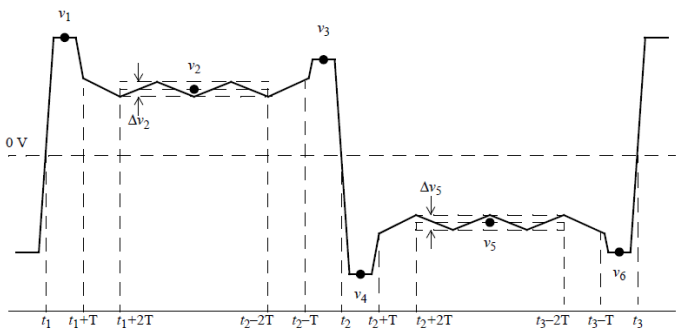

Figure 72-12—Transmitter output waveform

Transmitter output waveform requirements.

Measurement Details

72.7.1.11 Output Waveform Coefficient Update and Status – 10GBASE-KR requires the user to measure specific regions of the waveform such as overshoot and de-emphasis levels to determine the transmitter output equalization levels. There are six taps and the state of the transmitter equalizer, and as a result the transmitter output waveform, is manipulated according to the protocol defined in 72.6.10 of IEEE 802.3ap or through management. The changes in the transmitter output waveform resulting from coefficient update requests shall meet the requirements stated in Table 72-7 of IEEE 802.3ap. The coefficient update requests in Table 72-7 of IEEE 802.3ap are to be followed by a coefficient update equal to hold for all taps. The results shall be verified after the coefficient status for all taps is reported as not_updated.

For any coefficient update, the magnitudes of the changes in v_1 , v_2 , and v_3 shall be within 5 mV of each other. When sufficient increment or decrement updates have been applied to a given tap, it will reach a maximum or

Table 72-7—Transmitter output waveform requirements related to coefficient update

Coefficient update ^a			Requirements ^b		
$c(1)$	$c(0)$	$c(-1)$	$v_1(k) - v_1(k-1)$ (mV)	$v_2(k) - v_2(k-1)$ (mV)	$v_3(k) - v_3(k-1)$ (mV)
increment	hold	hold	-20 to -5	5 to 20	5 to 20
decrement	hold	hold	5 to 20	-20 to -5	-20 to -5
hold	increment	hold	5 to 20	5 to 20	5 to 20
hold	decrement	hold	-20 to -5	-20 to -5	-20 to -5
hold	hold	increment	5 to 20	5 to 20	-20 to -5
hold	hold	decrement	-20 to -5	-20 to -5	5 to 20

Transmitter output waveform requirements related to coefficient update.

Table 72-8—Transmitter output waveform requirements related to coefficient status

Coefficient status			Requirements		
$c(1)$	$c(0)$	$c(-1)$	R_{pre}	R_{pst}	v_2 (mV)
disabled	minimum	disabled	0.90 to 1.10	0.90 to 1.10	220 to 330
disabled	maximum	disabled	0.95 to 1.05	0.95 to 1.05	400 to 600
minimum	minimum	disabled	—	4.00 (min)	—
disabled	minimum	minimum	1.54 (min)	—	—

Transmitter output waveform requirements related to coefficient status.

minimum limit governed by the coefficient range or by restrictions placed on minimum steady-state or maximum peak voltage, and the coefficient status is reported accordingly. The transmitter output waveform shall meet the requirements of Table 72-8 of IEEE 802.3ap for all of the limiting cases represented in the table. Implementation of $c(-1)$ or $c(1)$ coefficient values greater than zero or less than the minimum defined by R_{pre} (min) and R_{pst} (min) is optional. A coefficient may be disabled by first asserting the preset control defined in IEEE 802.3 Table 45-55 and 45.2.1.78, then manipulating the other coefficients as required by the test.

This measurement, if done manually, is prone to human errors. Measuring 104 results and keeping track of each result could be problematic and is not the best use of an engineer's time. 10G-KR makes the job of an engineer easy by noting down all the values and tabulating them in a way which can be easily interpreted.

72.7.1.3 Signaling Speed – Measured using recommended signal PRBS11. The 10GBASE-KR signaling speed shall be 10.3125 ± 100 ppm.

72.7.1.4 Differential Peak-Peak Output Voltage (Max) – Measured using recommended signal PRBS11.

72.6.5 Differential Peak-Peak Output Voltage (Max) with Tx Disabled – Measured when Tx is disabled. The differential output voltage is constrained according to the transmitter output waveform requirements specified in 72.7.1.10 of IEEE 802.3ap. For a 1010 pattern, the peak-peak differential output voltage shall be less than 1200 mV, regardless of equalization setting. The transmitter output voltage shall be less than 30 mV peak-peak when disabled. The differential output voltage test pattern shall consist of no fewer than eight symbols of alternating polarity.

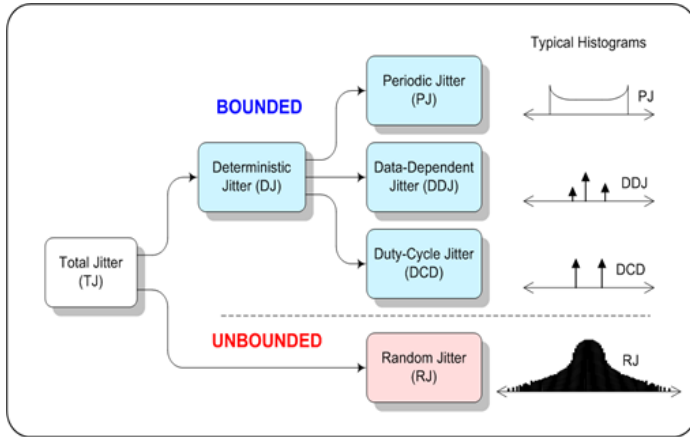

72.7.1.4 Common-mode Voltage Limits – Measured using recommended signal PRBS11. The common-mode voltage of SL <p> and SL <n> shall be between 0 V and 1.9 V with respect to signal ground.

72.7.1.7 Transition Time – Rise time and fall time measured using recommended signal N1N0 where $8 \leq N \leq 11$

The rising and falling edge transition times shall be between 24 ps and 47 ps as measured at the 20% and 80% levels referenced to v2 and v5 as defined in 72.7.1.11 of IEEE 802.3ap. Measurement is done using the square wave test pattern with no equalization and a run of at least eight consecutive ones and zeroes.

72.7.1.8 Max Output Jitter (Peak-Peak) – Measured using recommended signal PRBS11. Jitter components to be measured:

- Random jitter – 0.15 UI Peak-Peak
- Deterministic jitter – 0.15 UI Peak-Peak
- Duty cycle distortion – 0.035 UI Peak-Peak
- Total jitter – 0.28 UI Peak-Peak

For the purpose of jitter measurement, the effect of a single-pole high-pass filter with a 3 dB point at 4 MHz is applied to the jitter. Crossing times are defined with respect to the midpoint (0 V) of the AC-coupled differential signal. Equalization shall be off during jitter testing.

Transmit jitter test requirements are specified in 72.7.1.9 of IEEE 802.3ap. The transmitter shall have a maximum total jitter of 0.28 UI peak-peak, composed of a maximum deterministic component of 0.15 UI peak-peak and a maximum random component of 0.15 UI peak-peak. Duty cycle distortion (DCD) is considered a component of deterministic jitter and shall not exceed 0.035 UI peak-peak. The peak-peak duty cycle distortion is defined as the absolute value of the difference in the mean pulse width of a 1 pulse or the mean pulse width of a 0 pulse (as measured at the mean of the high- and low-voltage levels in a clock-like repeating 0101 bit

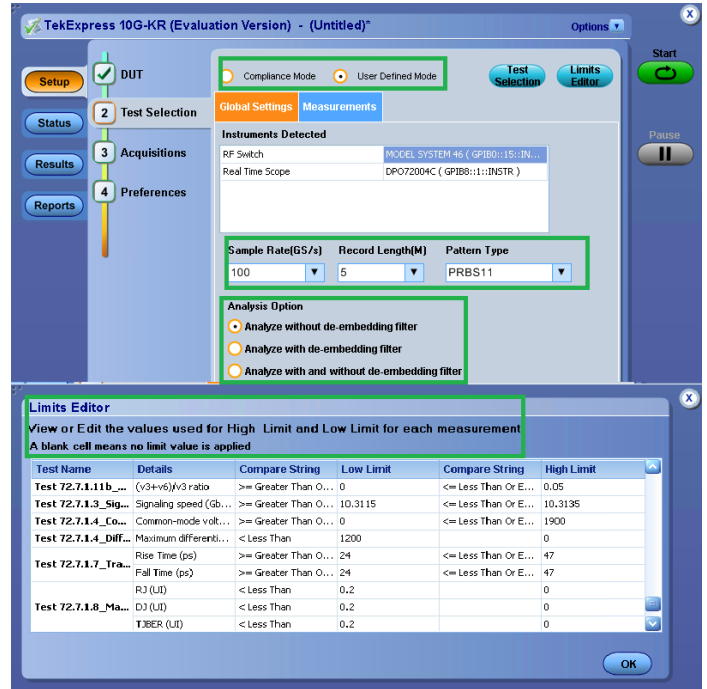

User can change limits, use filter files, and go beyond compliance.

sequence) and the nominal pulse width. Jitter specifications are specified for BER 10–12.

72.7.1.10 Output Waveform Characteristics – Measured using recommended signal N1N0 where $8 \leq N \leq 11$. The test pattern for the transmitter output waveform is the square wave test pattern defined in 52.9.1.2 of IEEE 802.3, with a run of at least eight consecutive ones. The transmitter output waveform test is based on the voltages v1 through v6, dv2, and dv5, which shall be measured as shown in Figure 72–12 of IEEE 802.3ap.

Simplified Instrument Setup – Save Time and Resources

Setup and test execution is simple with the 10G-KR solution. The oscilloscope acquisition and analysis are all controlled through the 10G-KR automation solution. The software’s graphical user interface (GUI) provides an intuitive workflow for setup and testing.

Margin Testing

Design characterization is supported beyond IEEE 802.3ap specification compliance requirements for all measurements. Qualify PHY with flexible control over test configurations such as analysis windows and other parameters. User-defined mode lets engineers make changes to the test limits and perform marginal testing beyond compliance.

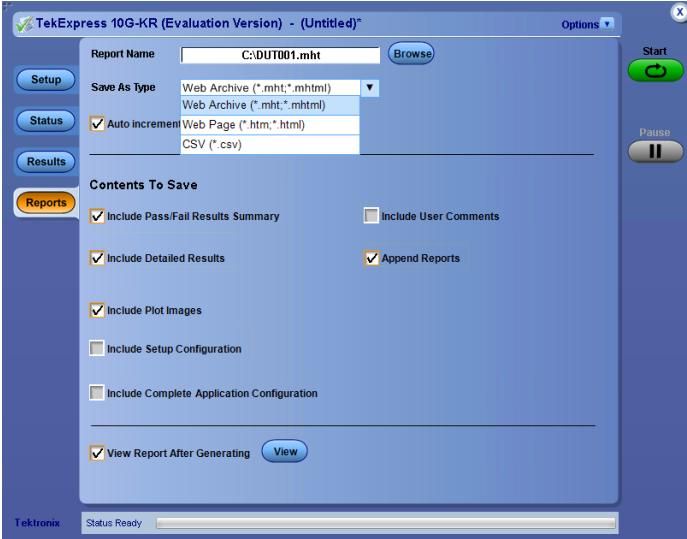

Report Configuration Menu – The report configuration menu lets users configure reports and it provides options such as auto-increment, appending, etc.

De-embedding Feature

As data rates increase, high-speed serial technologies have introduced new test methodologies and requirements for compliance testing. As technologies such as 10GBASE-KR increase in data rates, the eye is closed and different components such as SMA cables can be de-embedded to get better results. 10G-KR provides an option to de-embed the signal using .FLT files.

One-button Testing

Once the test bench is set up and the DUT is properly connected, simply press the Run button to perform the selected test suite. The 10G-KR solution prompts the end-user to put the DUT into different test modes by popping messages at regular intervals.

Automation Support

Save and recall setup files in automation script, with an option to automate the complete test bench. Tektronix end-users can call the 10G-KR application programmatically through NI LabVIEW, NI TestStand™, or any other scripting language for controlling 10G-KR along with other instrumentation such as thermal chambers and power supplies.

SMA Cables, Probe, and Keithley RF Switch Support

Design engineers who may want to solder the probe to the backplane copper lanes can do so because 10G-KR provides support for P7516, P7520, and P7520A TriMode probes. Engineers who want to make use of cost-effective SMA cables can directly connect SMA cables to their devices

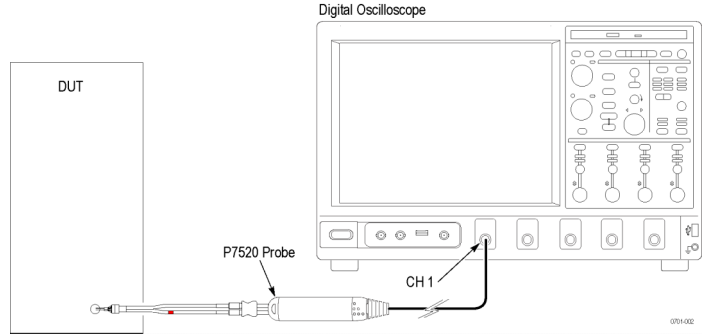

Connection diagram for differential input.

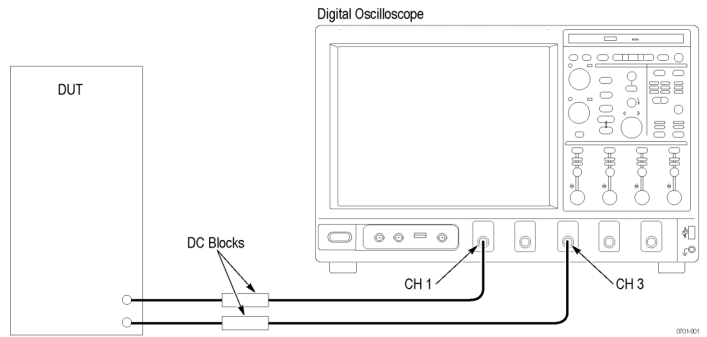

Connection diagram for single-ended input.

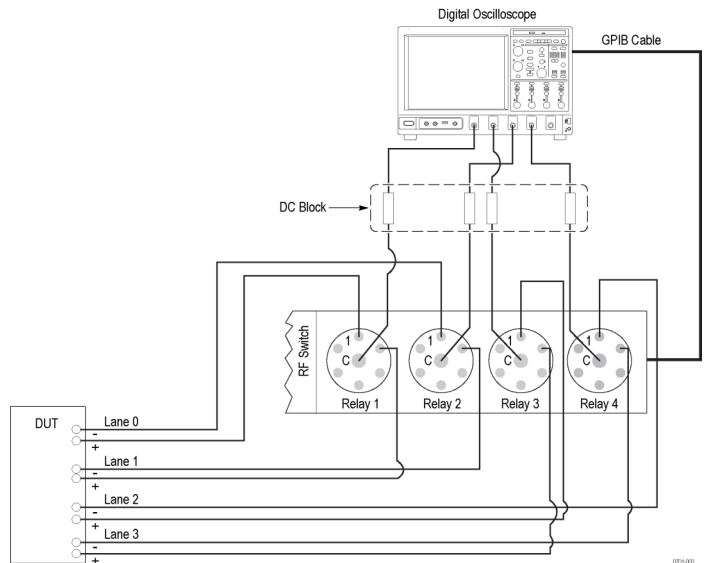

Connection diagram using RF switch.

and monitor the signals on the Tektronix oscilloscopes. Engineers working on four lanes of KR can make use of Keithley RF switches to automate their complete setup.

Table 72-6—Transmitter characteristics for 10GBASE-KR

Sub-Clause Reference	Measurement Name	Recommended Pattern for testing	Value	Unit
72.7.1.3	Signaling speed	PRBS11	10.3125 ± 100 ppm	GBd
72.7.1.4	Differential peak-to-peak output voltage (max.)	PRBS11	1200	mV
72.6.5	Differential peak-to-peak output voltage (max.) with TX disabled	PRBS11	30	mV
72.7.1.4	Common-mode voltage limits	PRBS11	0-1.9	V
	Transition time (20%–80%)			
	- Rise Time			
72.7.1.7	- Fall Time	N1N0 (8<=N<=11)	24 – 47	ps
	Jitter Measurements			
	- Max output jitter (peak-to-peak)		0.15	UI
	- Random jitter		0.15	UI
	- Deterministic jitter		0.035	UI
72.7.1.8	- Duty Cycle	PRBS11	0.28	UI
72.7.1.10	Output waveform characteristics	N1N0 (8<=N<=11)	Equalizer Parameter	mV
72.7.1.11	Output waveform coefficient update	N1N0 (8<=N<=11)	Equalizer Parameter	mV
72.7.1.11	Output waveform coefficient status	N1N0 (8<=N<=11)	Equalizer Parameter	mV

IEEE 802.3ap specifications measurements covered on 10G-KR.

Prerecorded Waveform

Prerecorded waveform support provides users with an option to use prerecorded waveforms when an oscilloscope is not available. This feature allows waveforms to be shared across multiple locations and removes end-user dependency on using scopes all the time.

Pass/Fail Report

TekExpress KR
Detailed Report

DUT ID: DUT001
Date/Time: June 15, 2012 / 19:07:12
CTS Version: CTS 0.9
Overall Compliance Mode: TRUE
Overall Test Result: FAIL
Scope Model: DP072004C
Scope Serial Number: B130222
Probe Model (CH1): "1X"
Probe Serial Number (CH1): "N/A"
Probe Model (CH2): "N/A"
Probe Serial Number (CH2): "N/A"
Probe Model (CH3): "TCA2920"
Probe Serial Number (CH3): "N/A"
Probe Model (CH4): "N/A"
Probe Serial Number (CH4): "N/A"

TekEx

Pattern-Rec length	Lane	c(1)	c(0)	c(-1)	Measurement Details	Measured value	Units	Test Result	Max
PRBS11 5M	Lane0	N.A.	N.A.	N.A.	Signal	10.3122	Cbps	Pass	0.001 0.001
PRBS11 5M	Lane0	N.A.	N.A.	N.A.	P2P-Tx enabled	622.4104	mV	Pass	577.59
					DGD	0.0253	UI	Pass	0.175
					Rj	0.0044	UI	Pass	0.196
					Dj	0.3259	UI	Fail	0.128
					DEBER	0.3684	UI	Fail	0.168
DPBS11 6M	Lane0	N.A.	N.A.	N.A.	Common-mode DP2P	0.2	mV	Pass	1808

10G-KR report.

A summary report in .MHT (MHTML) format with Pass/Fail status is automatically generated after tests complete. The report includes test configuration details, waveform plots, and margin analysis to provide more insight into your design.

10GBASE-KR Custom Decode Feature

10G-KR Custom Decode provides protocol decoding to disassemble the 10GBASE-KR Ethernet 64b/66b traffic, including time-correlated views of physical and Protocol layers. Decode results are displayed as a waveform and an event-table, along with red flags on CRC/ECC errors in the decoded data. You can view protocol decode along with time stamps on the decoded data in event-tables.

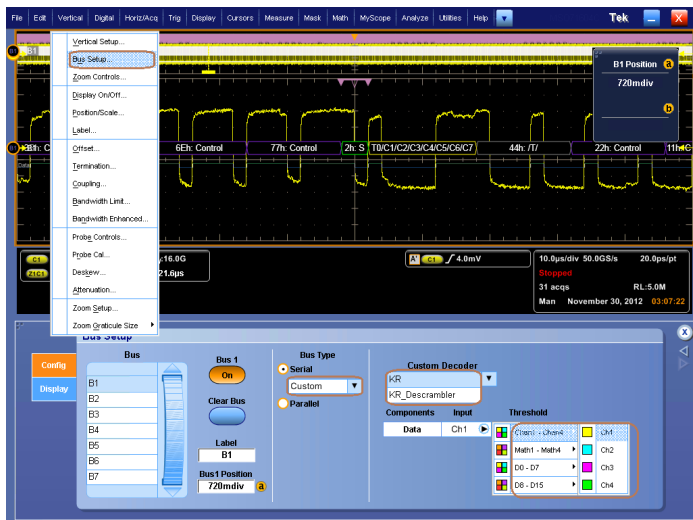

10G-KR Custom Decode

Features and Values

10G-KR protocol Decode solution offers several features to simplify validation of 64b/66b designs. Key features that add value proposition to design engineers working on 10GBASE-KR products include:

- Setup wizard for quick setup, configuration and test
- Packet-level decoding of primitives, as well as link and transaction layers, helps capture abnormalities
- Serial data analysis of 64b/66b bit streams
- Decoding of scrambled and unscrambled symbols provides engineers two different views on the data
- Ability to save symbol and packet data lists to csv files for offline analysis
- Packet decode details tab provides detailed information on packets:
 - Packet information
 - Channel information (Live channel, Math)
 - Listing index
 - Control symbols
 - Reserved-bit settings
 - Packet length
- Quick search capability for specific symbols provides a fast method to search on different areas of interest

Comprehensive Search Capability

The 10G-KR packet content search function is very useful for isolating an event of interest. Once you have captured an event and need to analyze the surrounding data, what do you do? In the past, you had to manually scroll through the waveform data, counting and converting bits, to determine what caused the event. The 10G-KR protocol decoder search function speeds up event analysis by letting you enter criteria (such as serial packet content) to quickly look through the acquired data for specific events. The search engine marks each occurrence in the data. You can then use the Previous and Next buttons on the instrument to rapidly navigate between marks.

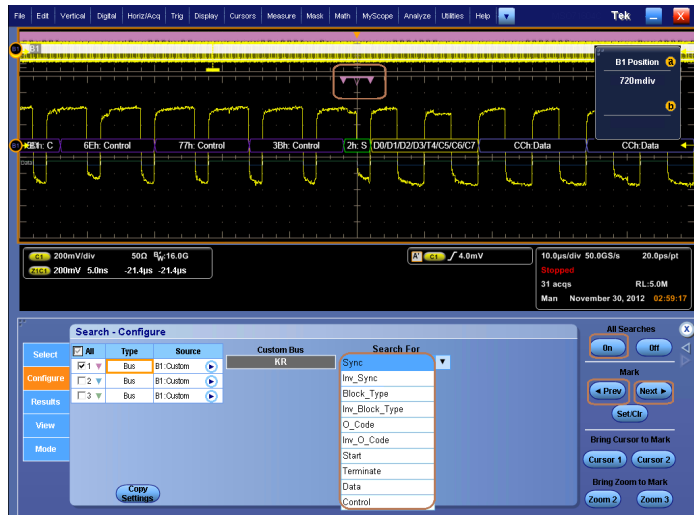

Comprehensive search capability

The Results tab shows the list of search hits. Click on an item in the list to go to the associated position on the waveform.

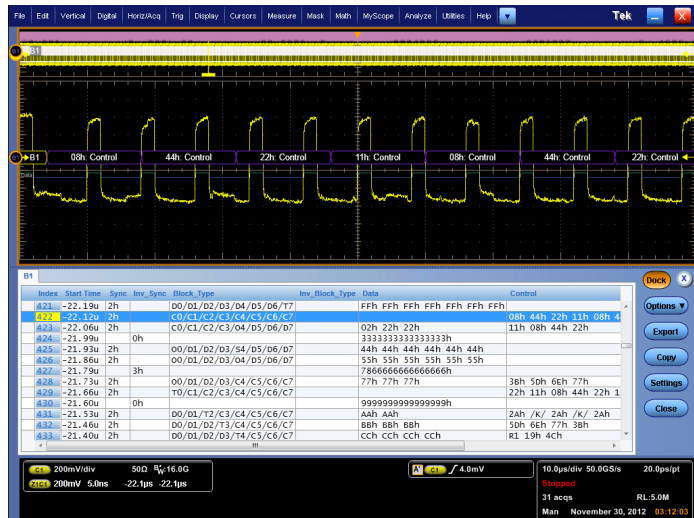

10G-KR Decoder search results

Ordering Information

10G-KR

10GBASE-KR/KR4 Compliance and Debug Solution.

To Order Along with Oscilloscope

Oscilloscope	Option
DPO/DSA/MSO70000	10G-KR

To Upgrade an Existing Oscilloscope

Oscilloscope	Option
DPO/DSA/MSO70000	DPO-UP 10G-KR DPOFL-10G-KR (Floating License) DPOFT-10G-KR (Floating Trial)

Recommended Equipment

Product Type	Models
Oscilloscopes	DPO/DSA/MSO71604C DPO/DSA/MSO72004C DPO/DSA72504D DPO/DSA73304D
Software	10G-KR and DJA*1
Accessories	Matched-pair SMA cables (TCA-SMA connector) or P7516, P7520, P7520A TriMode probes Keithley Switch for KR4 support – S46
DC Blocks	Model 5501A DC Block Picosecond

*1 Prerequisite for 10G-KR.

Contact Tektronix:

- ASEAN / Australasia** (65) 6356 3900
- Austria** 00800 2255 4835*
- Balkans, Israel, South Africa and other ISE Countries** +41 52 675 3777
- Belgium** 00800 2255 4835*
- Brazil** +55 (11) 3759 7627
- Canada** 1 800 833 9200
- Central East Europe and the Baltics** +41 52 675 3777
- Central Europe & Greece** +41 52 675 3777
- Denmark** +45 80 88 1401
- Finland** +41 52 675 3777
- France** 00800 2255 4835*
- Germany** 00800 2255 4835*
- Hong Kong** 400 820 5835
- India** 000 800 650 1835
- Italy** 00800 2255 4835*
- Japan** 81 (3) 6714 3010
- Luxembourg** +41 52 675 3777
- Mexico, Central/South America & Caribbean** 52 (55) 56 04 50 90
- Middle East, Asia, and North Africa** +41 52 675 3777
- The Netherlands** 00800 2255 4835*
- Norway** 800 16098
- People's Republic of China** 400 820 5835
- Poland** +41 52 675 3777
- Portugal** 80 08 12370
- Republic of Korea** 001 800 8255 2835
- Russia & CIS** +7 (495) 7484900
- South Africa** +41 52 675 3777
- Spain** 00800 2255 4835*
- Sweden** 00800 2255 4835*
- Switzerland** 00800 2255 4835*
- Taiwan** 886 (2) 2722 9622
- United Kingdom & Ireland** 00800 2255 4835*
- USA** 1 800 833 9200

* European toll-free number. If not accessible, call: +41 52 675 3777

Updated 10 February 2011

For Further Information. Tektronix maintains a comprehensive, constantly expanding collection of application notes, technical briefs and other resources to help engineers working on the cutting edge of technology. Please visit www.tektronix.com



Copyright © Tektronix, Inc. All rights reserved. Tektronix products are covered by U.S. and foreign patents, issued and pending. Information in this publication supersedes that in all previously published material. Specification and price change privileges reserved. TEKTRONIX and TEK are registered trademarks of Tektronix, Inc. All other trade names referenced are the service marks, trademarks, or registered trademarks of their respective companies.

21 Jan 2013

61W-28213-1

