



# 2SA2125/2SC5964

## Bipolar Transistor (-50V, (-)3A, Low $V_{CE(sat)}$ , (PNP)NPN Single PCP

ON Semiconductor®

<http://onsemi.com>

### Applications

- DC / DC converter, relay drivers, lamp drivers, motor drivers, flash

### Features

- Adoption of MBIT process
- Low collector to emitter saturation voltage
- Halogen free compliance
- Large current capacity
- High-speed switching

### Specifications ( ) : 2SA2125

Absolute Maximum Ratings at  $T_a=25^\circ\text{C}$

Parameter	Symbol	Conditions	Ratings	Unit
Collector to Base Voltage	$V_{CBO}$		(-50)100	V
Collector to Emitter Voltage	$V_{CES}$		(-50)100	V
	$V_{CEO}$		(-50)	V
Emitter to Base Voltage	$V_{EBO}$		(-6)	V

Continued on next page.

Stresses exceeding Maximum Ratings may damage the device. Maximum Ratings are stress ratings only. Functional operation above the Recommended Operating Conditions is not implied. Extended exposure to stresses above the Recommended Operating Conditions may affect device reliability.

### Package Dimensions

unit : mm (typ)

7007B-004

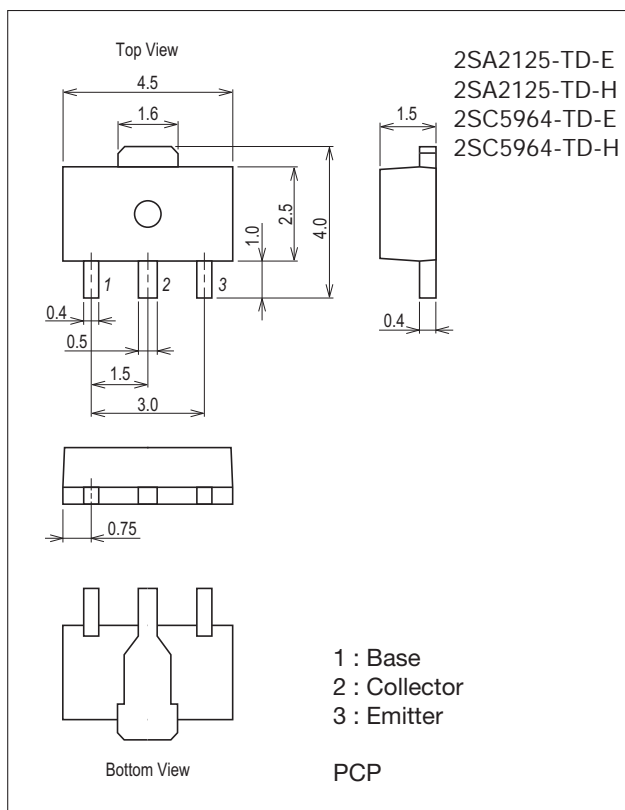

### Product & Package Information

- Package : PCP
- JEITA, JEDEC : SC-62, SOT-89, TO-243
- Minimum Packing Quantity : 1,000 pcs./reel

### Packing Type: TD

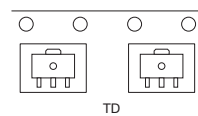

### Marking

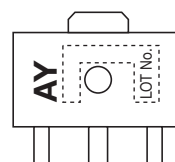

2SA2125

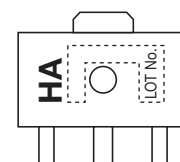

2SC5964

### Electrical Connection

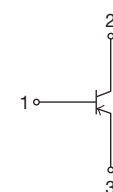

2SA2125

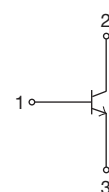

2SC5964

## 2SA2125/2SC5964

Continued from preceding page.

Parameter	Symbol	Conditions	Ratings	Unit
Collector Current	$I_C$		(-) $3$	A
Collector Current (Pulse)	$I_{CP}$		(-) $6$	A
Base Current	$I_B$		(-) $600$	mA
Collector Dissipation	$P_C$	When mounted on ceramic substrate (250mm <sup>2</sup> ×0.8mm)	$1.3$	W
		$T_c=25^\circ\text{C}$	$3.5$	W
Junction Temperature	$T_J$		$150$	$^\circ\text{C}$
Storage Temperature	$T_{stg}$		$-55$ to $+150$	$^\circ\text{C}$

### Electrical Characteristics at $T_a=25^\circ\text{C}$

Parameter	Symbol	Conditions	Ratings			Unit
			min	typ	max	
Collector Cutoff Current	$I_{CBO}$	$V_{CB}=-40\text{V}, I_E=0\text{A}$			(-) $1$	$\mu\text{A}$
Emitter Cutoff Current	$I_{EBO}$	$V_{EB}=-4\text{V}, I_C=0\text{A}$			(-) $1$	$\mu\text{A}$
DC Current Gain	$h_{FE}$	$V_{CE}=-2\text{V}, I_C=-100\text{mA}$	$200$		$560$	
Gain-Bandwidth Product	$f_T$	$V_{CE}=-10\text{V}, I_C=-500\text{mA}$		(390)380		MHz
Output Capacitance	$C_{ob}$	$V_{CB}=-10\text{V}, f=1\text{MHz}$		(24)13		pF
Collector to Emitter Saturation Voltage	$V_{CE(sat)1}$	$I_C=-1\text{A}, I_B=-50\text{mA}$		(-125)100	(-230)150	mV
	$V_{CE(sat)2}$	$I_C=-2\text{A}, I_B=-100\text{mA}$		(-250)190	(-500)290	mV
Base to Emitter Saturation Voltage	$V_{BE(sat)}$	$I_C=-2\text{A}, I_B=-100\text{mA}$		(-) $0.94$	(-) $1.2$	V
Collector to Base Breakdown Voltage	$V_{(BR)CBO}$	$I_C=-10\mu\text{A}, I_E=0\text{A}$	(-) $50$	$100$		V
Collector to Emitter Breakdown Voltage	$V_{(BR)CES}$	$I_C=-100\mu\text{A}, R_{BE}=0\Omega$	(-) $50$	$100$		V
	$V_{(BR)CEO}$	$I_C=-1\text{mA}, R_{BE}=\infty$	(-) $50$			V
Emitter to Base Breakdown Voltage	$V_{(BR)EBO}$	$I_E=-10\mu\text{A}, I_C=0\text{A}$	(-) $6$			V
Turn-ON Time	$t_{on}$	See specified Test Circuit.		(30)35		ns
Storage Time	$t_{stg}$			(230)300		ns
Fall Time	$t_f$			(18)25		ns

### Switching Time Test Circuit

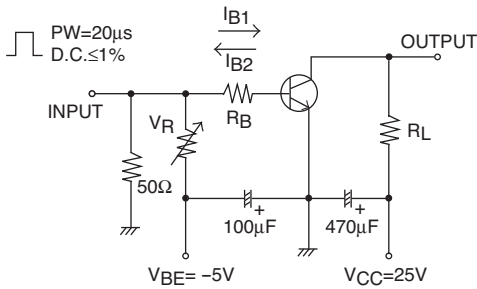

$$I_C = 10I_{B1} = -10I_{B2} = 1\text{A}$$

For PNP, the polarity is reversed.

### Ordering Information

Device	Package	Shipping	memo
2SA2125-TD-E	PCP	1,000pcs./reel	Pb Free
2SA2125-TD-H	PCP	1,000pcs./reel	Pb Free and Halogen Free
2SC5964-TD-E	PCP	1,000pcs./reel	Pb Free
2SC5964-TD-H	PCP	1,000pcs./reel	Pb Free and Halogen Free

2SA2125/2SC5964

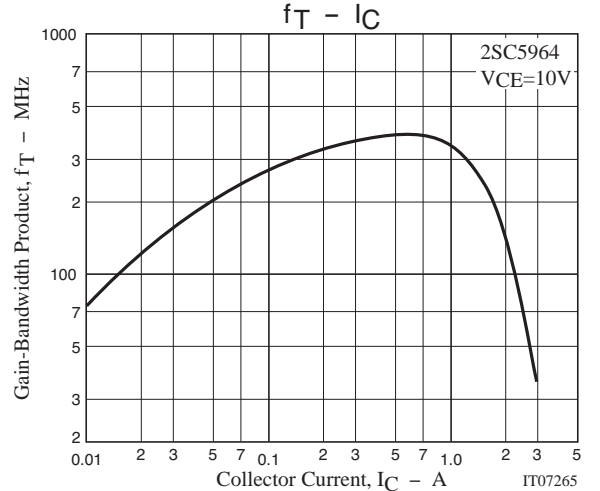
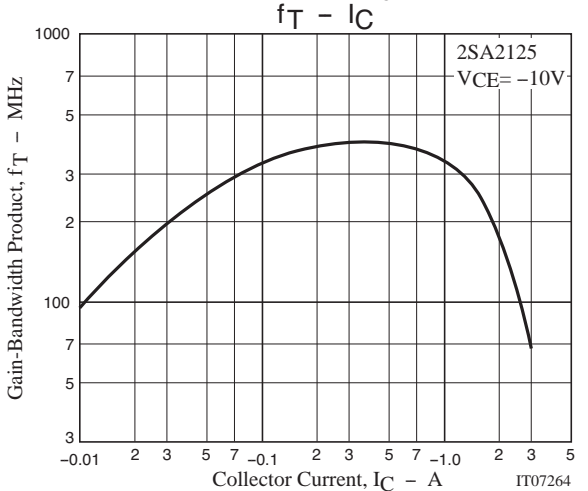
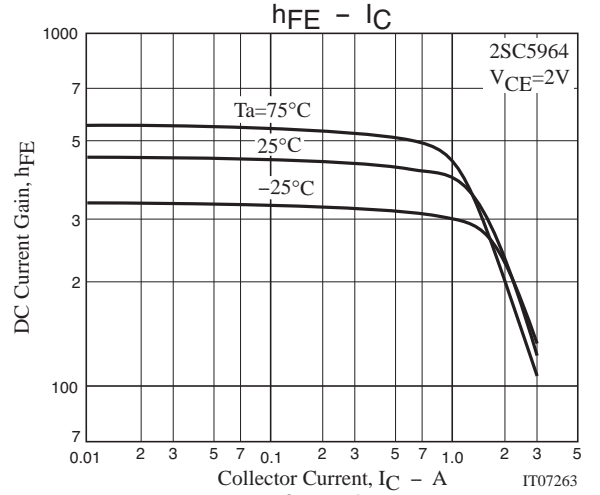
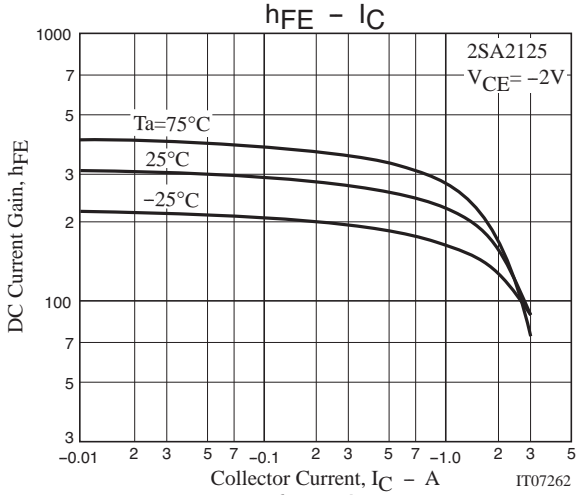
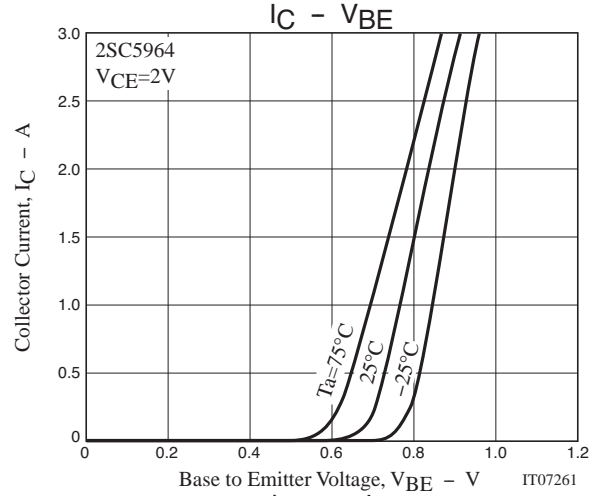
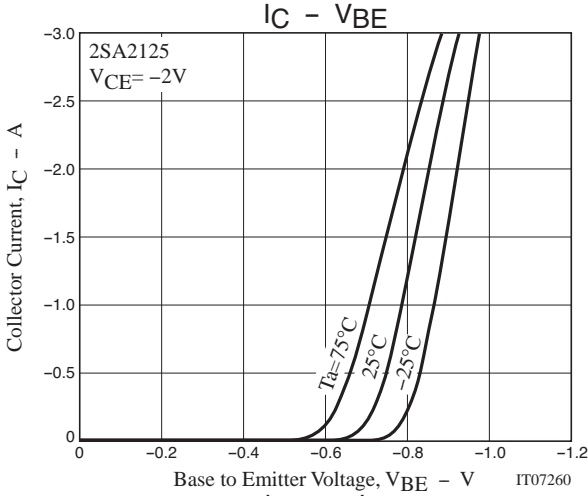
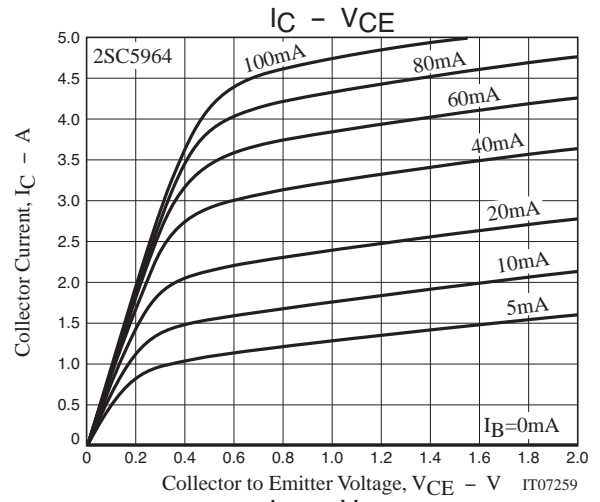
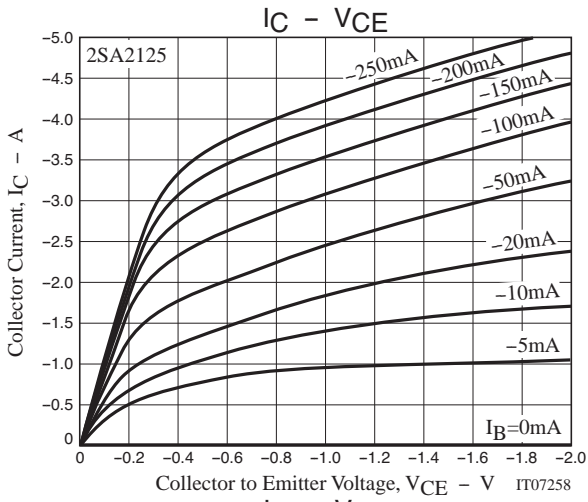

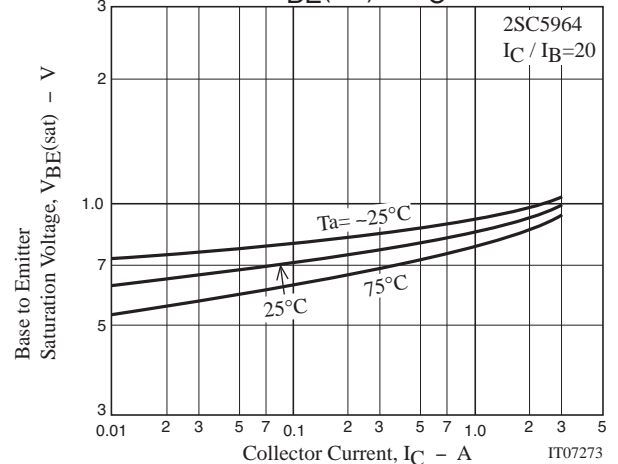
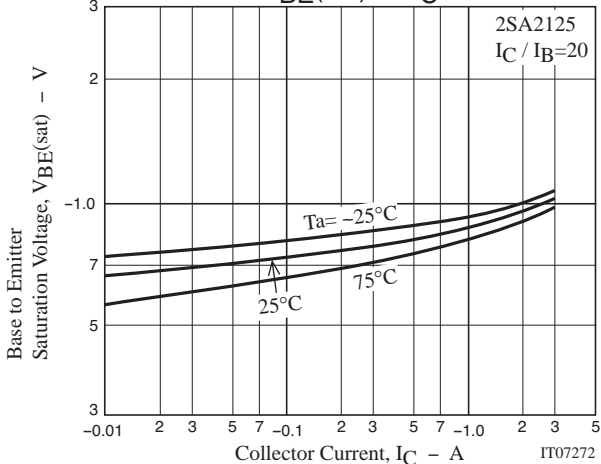
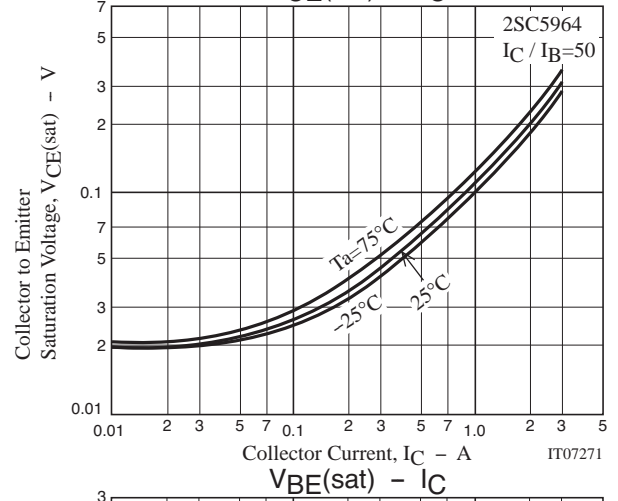
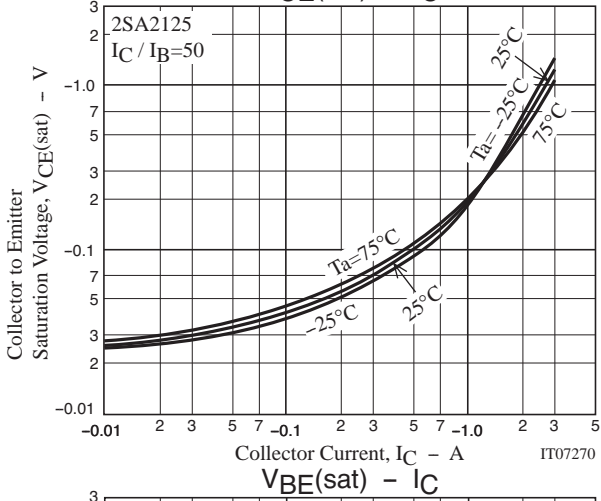
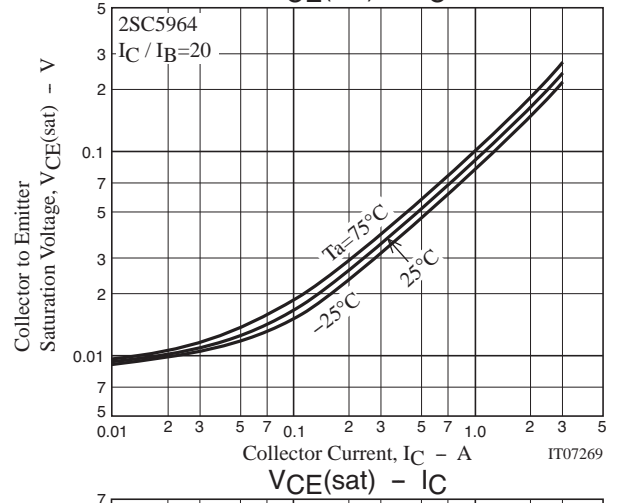
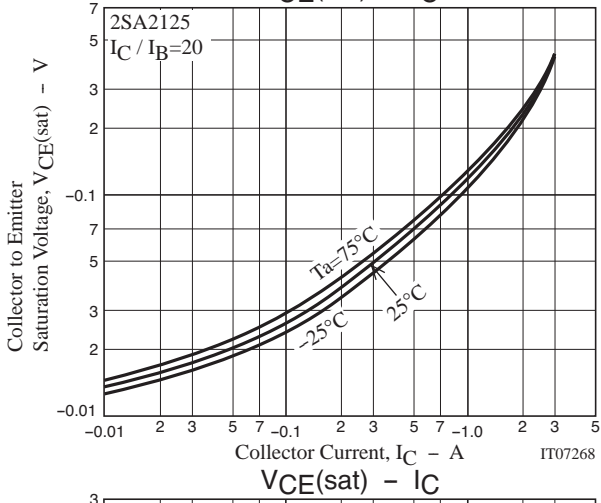
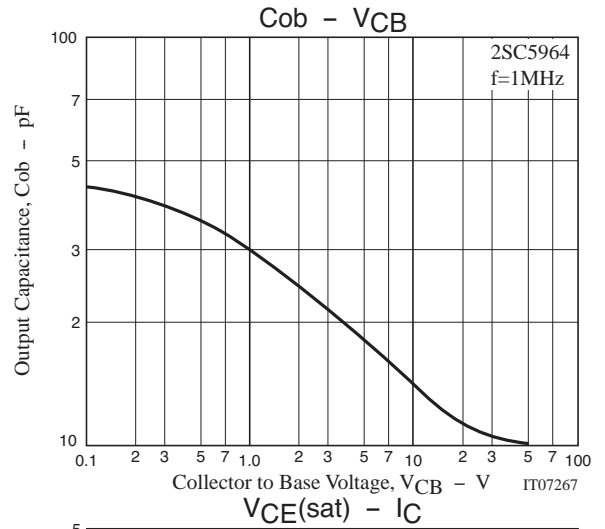
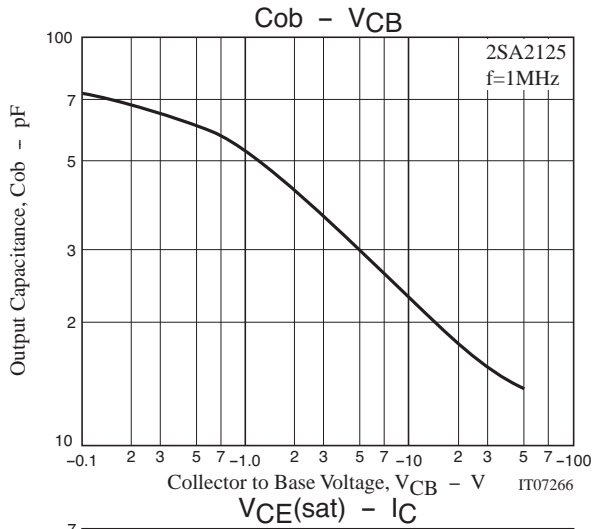

2SA2125/2SC5964

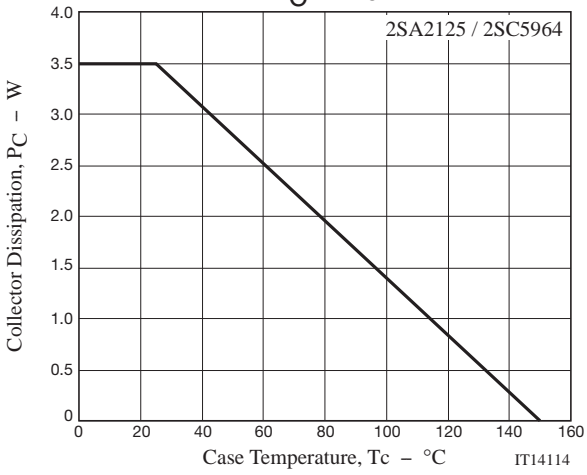
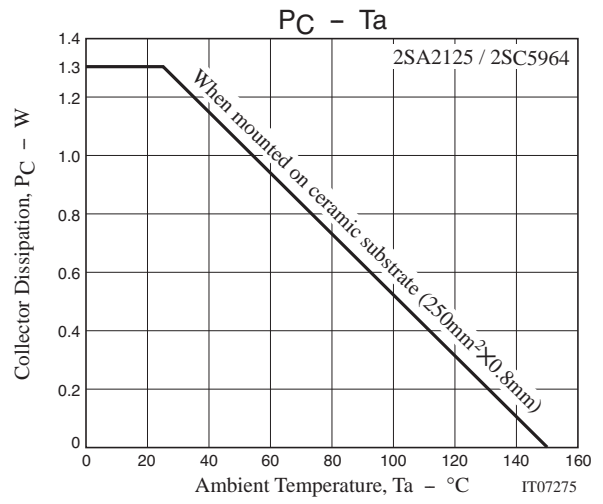
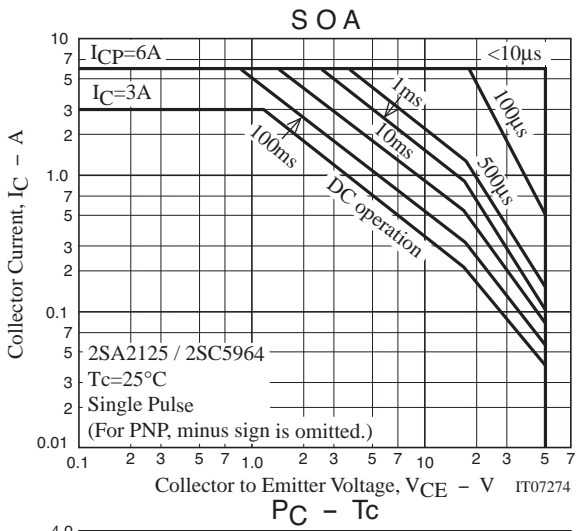

# 2SA2125/2SC5964

## Outline Drawing

2SA2125-TD-E, 2SA2125-TD-H, 2SC5964-TD-E, 2SC5964-TD-H

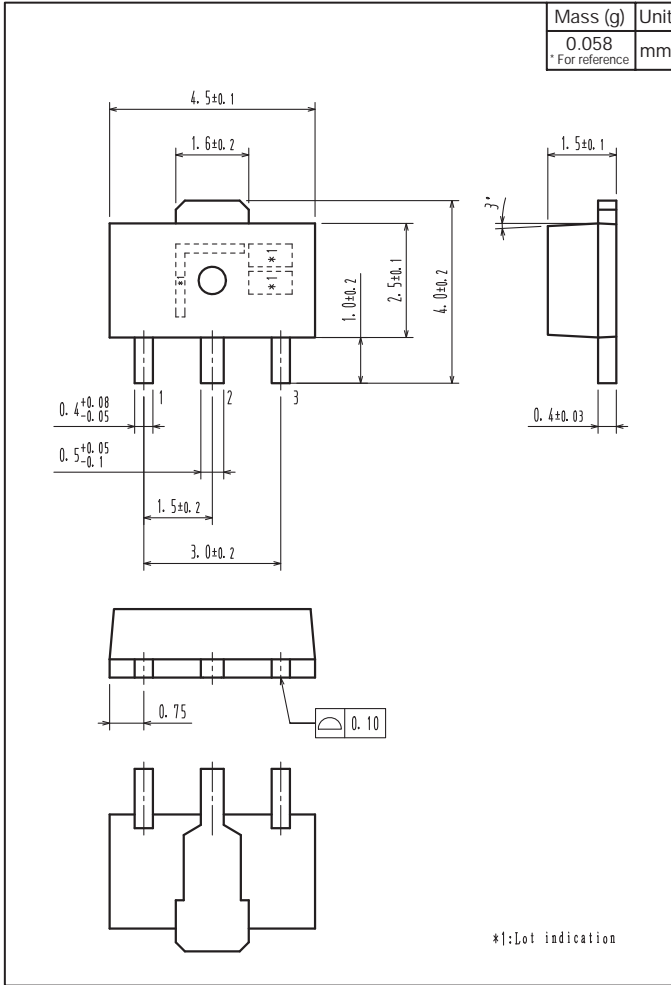

## Land Pattern Example

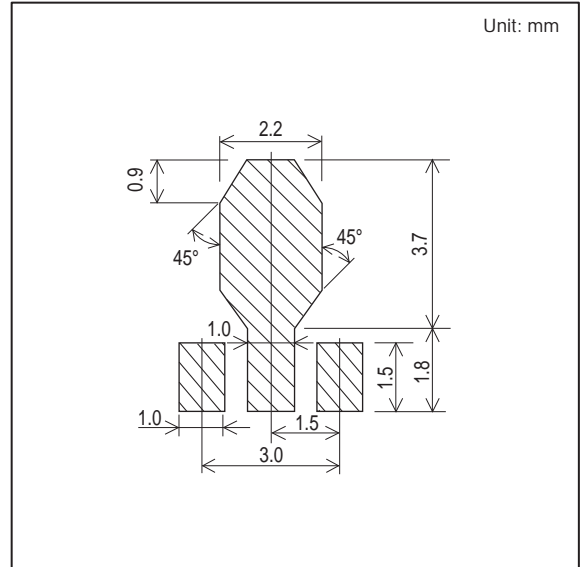

ON Semiconductor and the ON logo are registered trademarks of Semiconductor Components Industries, LLC (SCILLC). SCILLC owns the rights to a number of patents, trademarks, copyrights, trade secrets, and other intellectual property. A listing of SCILLC's product/patent coverage may be accessed at [www.onsemi.com/site/pdf/Patent-Marking.pdf](http://www.onsemi.com/site/pdf/Patent-Marking.pdf). SCILLC reserves the right to make changes without further notice to any products herein. SCILLC makes no warranty, representation or guarantee regarding the suitability of its products for any particular purpose, nor does SCILLC assume any liability arising out of the application or use of any product or circuit, and specifically disclaims any and all liability, including without limitation special, consequential or incidental damages. "Typical" parameters which may be provided in SCILLC data sheets and/or specifications can and do vary in different applications and actual performance may vary over time. All operating parameters, including "Typicals" must be validated for each customer application by customer's technical experts. SCILLC does not convey any license under its patent rights nor the rights of others. SCILLC products are not designed, intended, or authorized for use as components in systems intended for surgical implant into the body, or other applications intended to support or sustain life, or for any other application in which the failure of the SCILLC product could create a situation where personal injury or death may occur. Should Buyer purchase or use SCILLC products for any such unintended or unauthorized application, Buyer shall indemnify and hold SCILLC and its officers, employees, subsidiaries, affiliates, and distributors harmless against all claims, costs, damages, and expenses, and reasonable attorney fees arising out of, directly or indirectly, any claim of personal injury or death associated with such unintended or unauthorized use, even if such claim alleges that SCILLC was negligent regarding the design or manufacture of the part. SCILLC is an Equal Opportunity/Affirmative Action Employer. This literature is subject to all applicable copyright laws and is not for resale in any manner.