

Ultra High Voltage Thyristor 1500 Amperes/12000 Volts

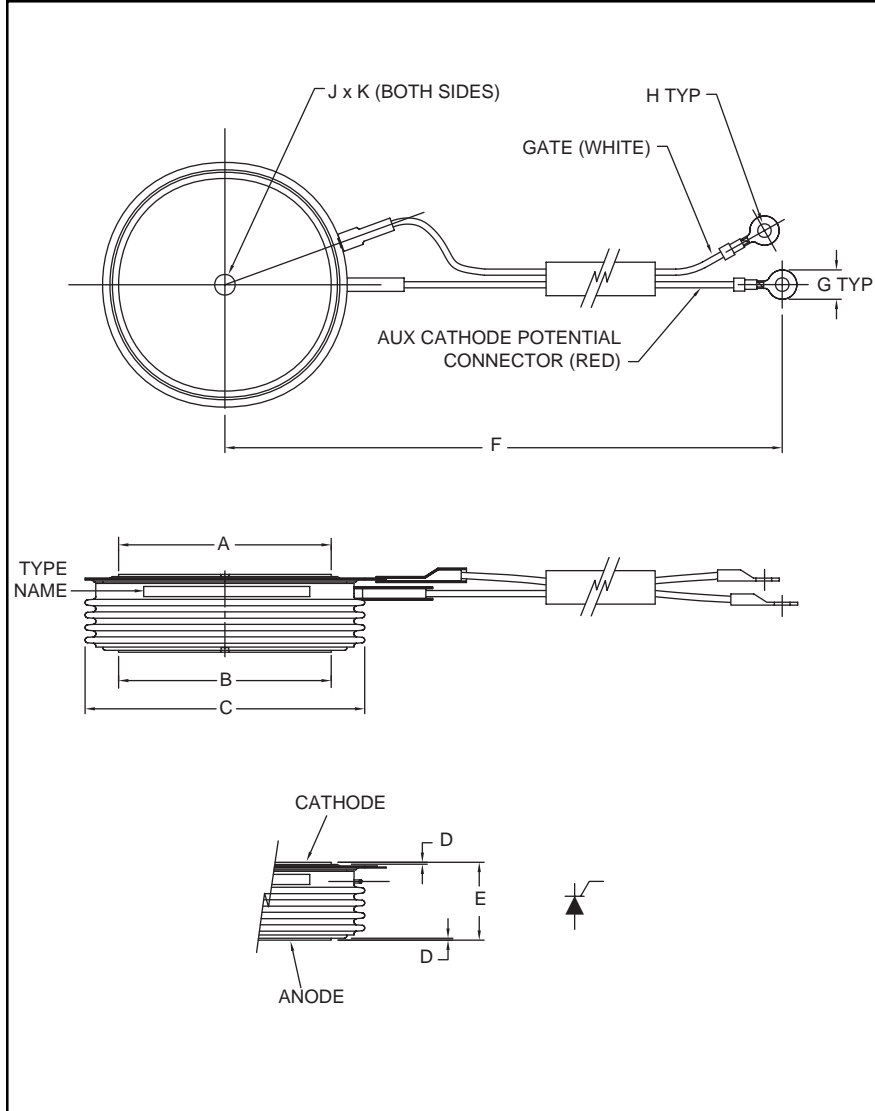

Outline Drawing and Circuit Diagram

Dimensions	Inches	Millimeters
A	4.13 Dia.	105.0 Dia.
B	4.13 Dia.	105.0 Dia.
C	6.5 Dia.	165.0 Dia.
D	0.2	0.40
E	1.38±0.02	35.0±0.5
F	17.99±0.39	457.0±10
G	0.30	7.5
H	0.17 Dia.	4.3 Dia.
J	0.14 Dia.	3.6±0.1 Dia.
K	0.09 Deep	2.2±0.1 Deep



Description:

Powerex Ultra High Voltage Thyristors are used in high voltage AC Switch and Static Var Compensator (SVC) applications.

Features:

- Average On-state Current ($I_{T(AV)} = 1500A$)
- Repetitive Peak Off-state Voltage ($V_{DRM} = 12000V$)
- Low On-state Voltage
- Press Pack Type

Applications:

- High Voltage AC Switch
- Static Var Compensator (SVC)

Ordering Information:

Example: Select the complete part module number you desire from the table below.

Device	Current Rating Amperes	Manu. Number	Type	Voltage Rating (x 50)
FT*	1500	A	U**	240

* Press Pack Thyristor

**Ultra High Voltage

Powerex, Inc., 200 Hillis Street, Youngwood, Pennsylvania 15697-1800 (724) 925-7272

FT1500AU-240
Ultra High Voltage Thyristor
 1500 Amperes/12000 Volts

Absolute Maximum Ratings, $T_j = 25^\circ\text{C}$ unless otherwise specified

Ratings	Symbol	FT1500AU-240	Units
Repetitive Peak Reverse Voltage	V_{RRM}	12000	Volts
Non-Repetitive Peak Reverse Voltage	V_{RSM}	12000	Volts
DC Reverse Voltage	$V_{R(DC)}$	9600	Volts
Repetitive Peak Off-state Voltage	V_{DRM}	12000	Volts
Non-Repetitive Peak Off-state Voltage	V_{DSM}	12000	Volts
RMS On-state Current	$I_{T(RMS)}$	2360	Amperes
Average On-state Current, $f = 60\text{Hz}$, Sine Wave $\theta = 180^\circ\text{C}$, $T_f = 88^\circ\text{C}$	$I_{T(AV)}$	1500	Amperes
Surge (Non-repetitive) On-state Current, One Half Cycle at 60Hz	I_{TSM}	34	kA
Current-squared, Time Integration, One Cycle at 60Hz	I^2t	4.8×10^6	A^2s
Critical Rate of Rise of On-state Current, $V_D = 1/2 V_{DRM}$, $I_G = 2.0\text{A}$, $T_j = 125^\circ\text{C}$	di_T/dt	100	$\text{A}/\mu\text{s}$
Peak Forward Gate Power Dissipation	P_{FGM}	30	Watts
Average Forward Gate Power Dissipation	$P_{FG(AV)}$	8.0	Watts
Peak Forward Gate Voltage	V_{FGM}	20	Volts
Peak Reverse Gate Voltage	V_{RGM}	10	Volts
Peak Forward Gate Current	I_{FGM}	6.0	Amperes
Junction Temperature	T_j	-40 to 125	$^\circ\text{C}$
Storage Temperature	T_{stg}	-40 to 150	$^\circ\text{C}$
Mounting Force Required, Recommended Value 118	–	108 ~ 132	kN
Weight, Standard Value	–	4000	Grams
DC Off-state Voltage	$V_{D(DC)}$	9600	Volts

Electrical Characteristics, $T_j = 25^\circ\text{C}$ unless otherwise specified

Characteristics	Symbol	Test Conditions	Min.	Typ.	Max.	Units
Repetitive Peak Reverse Current	I_{RRM}	$T_j = 125^\circ\text{C}$, V_{RRM} Applied	–	–	1200	mA
Repetitive Peak Off-state Current	I_{DRM}	$T_j = 125^\circ\text{C}$, V_{DRM} Applied	–	–	1200	mA
On-state Voltage	V_{TM}	$T_j = 125^\circ\text{C}$, $I_{TM} = 3000\text{A}$, Instantaneous Measurement	–	–	4.0	Volts
Critical Rate of Rise of Off-state Voltage	dv/dt	$T_j = 125^\circ\text{C}$, $V_D = 1/2 V_{DRM}$	2000	–	–	$\text{V}/\mu\text{s}$
Gate Trigger Voltage	V_{GT}	$T_j = 25^\circ\text{C}$, $V_D = 6\text{V}$, $R_L = 2\Omega$	–	–	2.5	Volts
Gate Non-trigger Voltage	V_{GD}	$T_j = 125^\circ\text{C}$, $V_D = 1/2 V_{DRM}$	0.2	–	–	Volts
Gate Trigger Current	I_{GT}	$T_j = 25^\circ\text{C}$, $V_D = 6\text{V}$, $R_L = 2\Omega$	–	–	350	mA

Thermal and Mechanical Characteristics, $T_j = 25^\circ\text{C}$ unless otherwise specified

Characteristics	Symbol	Test Conditions	Min.	Typ.	Max.	Units
Thermal Resistance, Junction to Fin	$R_{th(j-f)}$	–	–	–	0.005	$^\circ\text{C}/\text{W}$

Powerex, Inc., 200 Hillis Street, Youngwood, Pennsylvania 15697-1800 (724) 925-7272

FT1500AU-240
Ultra High Voltage Thyristor
 1500 Amperes/12000 Volts

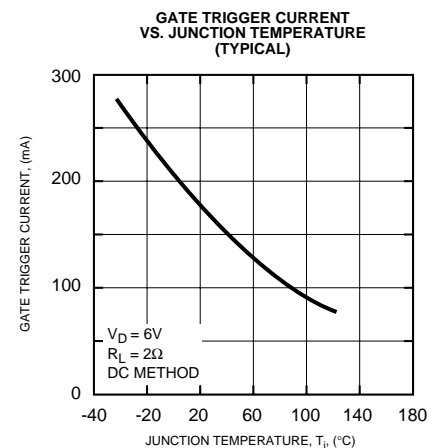
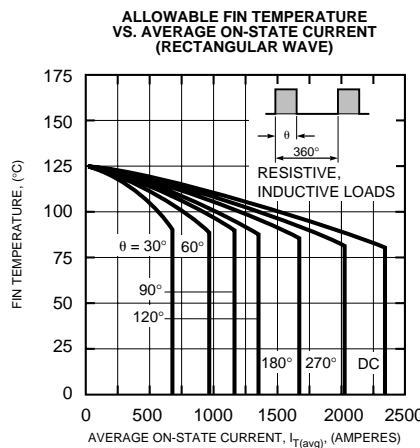
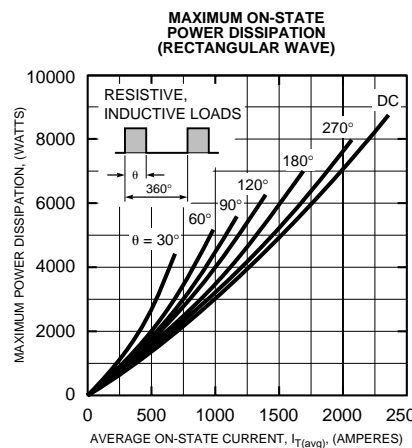
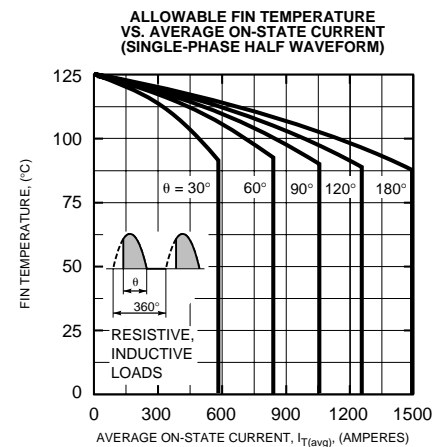
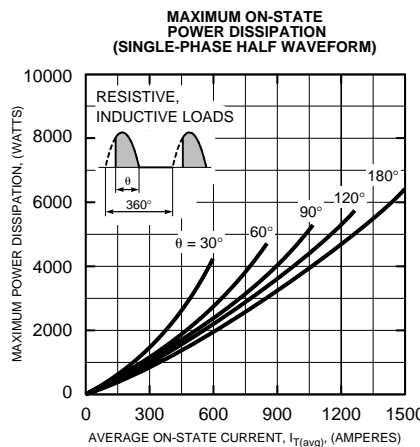
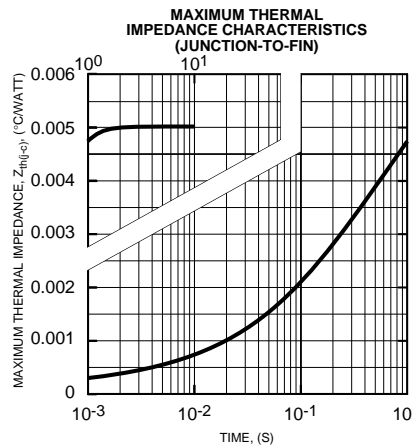
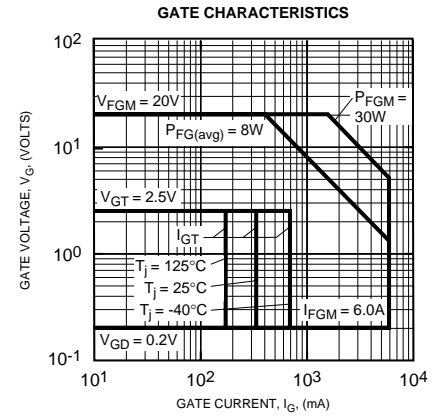
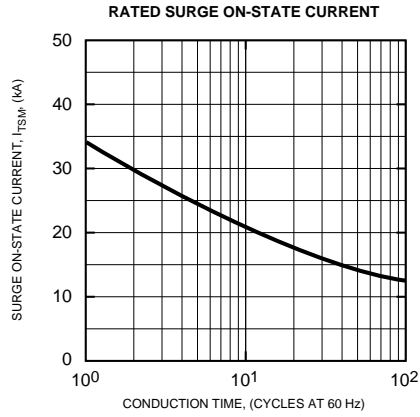
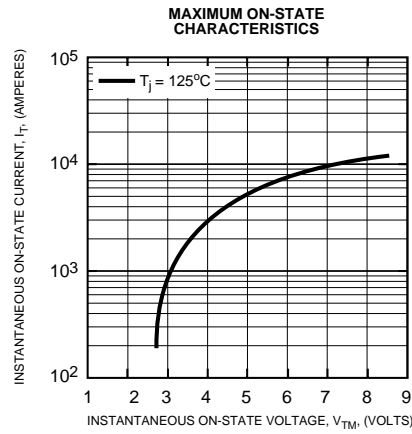

Powerex, Inc., 200 Hillis Street, Youngwood, Pennsylvania 15697-1800 (724) 925-7272

FT1500AU-240
Ultra High Voltage Thyristor
 1500 Amperes/12000 Volts

GATE TRIGGER VOLTAGE VS. JUNCTION TEMPERATURE (TYPICAL)

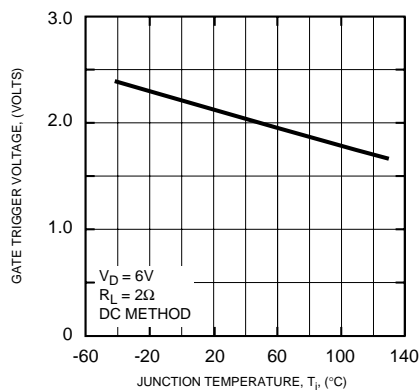

HOLDING CURRENT, LATCHING CURRENT VS. JUNCTION TEMPERATURE (TYPICAL)

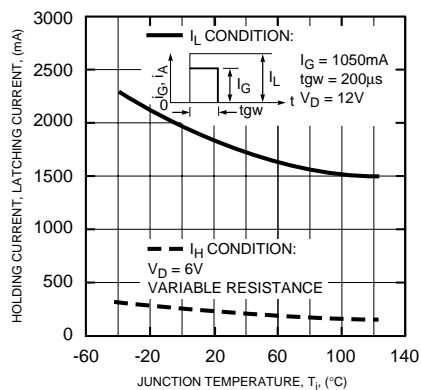

TURN-ON TIME VS. GATE CURRENT (TYPICAL)

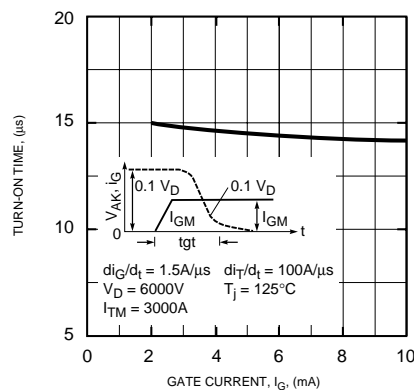

TURN-OFF TIME VS. JUNCTION TEMPERATURE (TYPICAL)

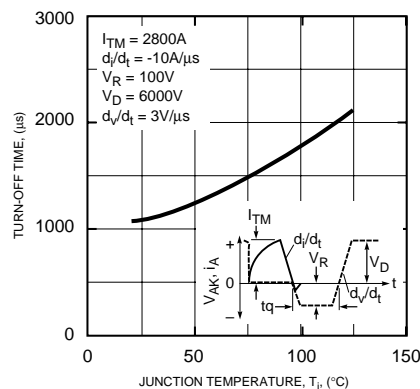

TURN-OFF TIME VS. RATE-OF-RISE OF OFF-STATE VOLTAGE (TYPICAL)

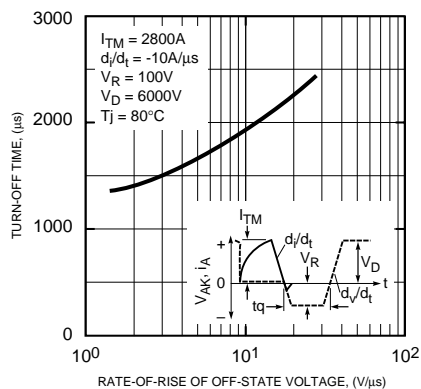

REVERSE RECOVERED CHARGE VS. JUNCTION TEMPERATURE (TYPICAL)

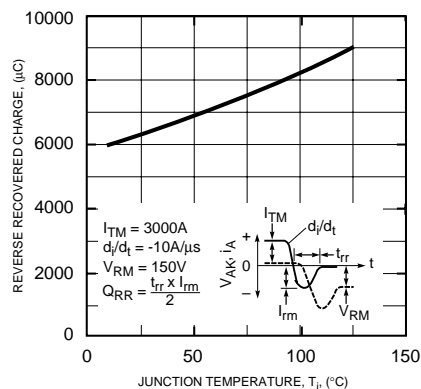

REVERSE RECOVERED CHARGE VS. RATE-OF-DECREASE OF ON-STATE CURRENT (TYPICAL)

