

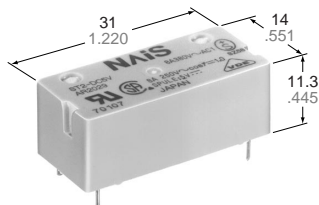

# IC DRIVABLE PC BOARD RELAY FOR FIELD LOAD SWITCHING

# ST-RELAYS



mm inch

## FEATURES

- Sealed to meet the combination process of automatic wave soldering and cleaning needs
- Latching types available
- High switching capacity and high sensitivity in subminiature size  
150 mW pick-up, 8 A inrush capacity: 51 A for 1a1b, 35 A for 2a
- High shock and vibration resistance  
Shock: 20 G, Vibration: 10 to 55 Hz at double amplitude of 2 mm

## SPECIFICATIONS

### Contacts

Arrangement	1 Form A 1 Form B	2 Form A	
Contact material	Gold flash over silver alloy		
Initial contact resistance, max.	30 mΩ		
Rating (resistive)	Max. switching power	2,000 VA, 150 W	
	Max. switching voltage	380 V AC, 30 V DC	
	Max. switching current	8 A	
HP rating	1/4 HP 125, 250 V AC		
Inrush current capability	51 A (TV-3 equivalence) for 1a1b 35 A (TV-1 equivalence) for 2a		
Expected life (min. operations)	Mechanical (at 180 cpm)		
	10 <sup>7</sup>		
	Electrical	8 A 250 V AC (resistive)	10 <sup>5</sup>
		5 A 30 V DC (resistive)	2 × 10 <sup>5</sup>
		3 A 100 V AC (lamp)	3 × 10 <sup>4</sup>
1 A 100 V AC (lamp)		—	
		3 × 10 <sup>4</sup>	

### Coil (polarized) (at 25°C 77°F)

Single side stable	Nominal operating power	Approx. 240 mW
Latching	Nominal set and reset power	Approx. 240 mW

### Remarks

- \* Specifications will vary with foreign standards certification ratings.
- \*1 Measurement at same location as "Initial breakdown voltage" section
- \*2 Detection current: 10 mA
- \*3 Wave is standard shock voltage of ±1.2 × 50μs according to JEC-212-1981
- \*4 Excluding contact bounce time
- \*5 Half-wave pulse of sine wave: 11ms; detection time: 10μs
- \*6 Half-wave pulse of sine wave: 6ms
- \*7 Detection time: 10μs
- \*8 Refer to 5. Conditions for operation, transport and storage mentioned in AMBIENT ENVIRONMENT (Page 61).

### Characteristics (at 25°C 77°F 50% Relative humidity)

Max. operating speed	20 cpm (at rated load)	
Initial insulation resistance*1	1,000 MΩ (at 500 V DC)	
Initial breakdown voltage*2	Between contact sets	2,000 Vrms
	Between open contacts	1,200 Vrms
	Between contacts and coil	3,750 Vrms
Surge voltage between coil and contact*3	Min. 6,000 V	
Operate time*4 (at nominal voltage)	Max. 15 ms (Approx. 10 ms)	
Release time (without diode)*4 (at nominal voltage)	Max. 10 ms (Approx. 8 ms)	
Set time*4 (latching) (at nominal voltage)	Max. 10 ms (Approx. 8 ms)	
Reset time*4 (latching) (at nominal voltage)	Max. 10 ms (Approx. 8 ms)	
Temperature rise (at 60°C)	Max. 55°C with nominal coil voltage and at 8 A switching current	
Shock resistance	Functional*5	Min. 196 m/s <sup>2</sup> {20 G}
	Destructive*6	Min. 980 m/s <sup>2</sup> {100 G}
Vibration resistance	Functional*7	117.6 m/s <sup>2</sup> {12 G}, 10 to 55 Hz at double amplitude of 2 mm
	Destructive	176.4 m/s <sup>2</sup> {18 G}, 10 to 55 Hz at double amplitude of 3 mm
Conditions for operation, transport and storage*8 (Not freezing and condensing at low temperature)	Ambient temp.	-40°C to +60°C -40°F to +140°F
	Humidity	5 to 85% R.H.
Unit weight	Approx. 10g .353 oz	

## TYPICAL APPLICATIONS

Sequence controllers, facsimiles, telephone controls, remote control security devices and security equipment.

## ORDERING INFORMATION

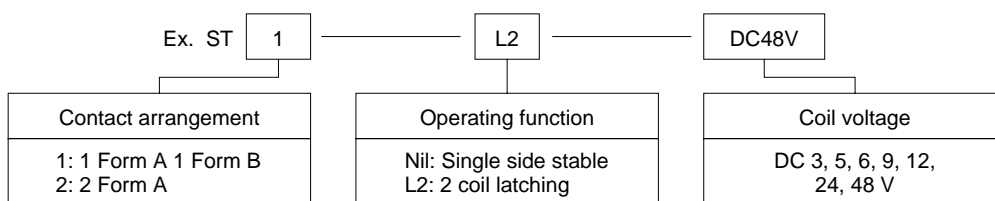

(Note) Standard packing: Carton; 50 pcs., Case; 500 pcs.

## TYPES AND COIL DATA (at 20°C 68°F)

### Single side stable

Part No.		Nominal voltage, V DC	Pick-up voltage, V DC (max.)	Drop-out voltage, V DC (min.)	Maximum allowable voltage, V DC (60°C 140°F)	Coil resistance, Ω (±10%)	Nominal operating current, mA
1 Form A 1 Form B	2 Form A						
ST1-DC3V	ST2-DC3V	3	2.4	0.3	4.5	38	75
ST1-DC5V	ST2-DC5V	5	4.0	0.5	7.5	105	47
ST1-DC6V	ST2-DC6V	6	4.8	0.6	9.0	150	40
ST1-DC9V	ST2-DC9V	9	7.2	0.9	13.5	360	25
ST1-DC12V	ST2-DC12V	12	9.6	1.2	18.0	600	20
ST1-DC24V	ST2-DC24V	24	19.2	2.4	36.0	2,400	10
ST1-DC48V	ST2-DC48V	48	38.4	4.8	72.0	9,000	4.7

### 2 coil latching

Part No.		Nominal voltage, V DC	Set and reset voltage, V DC (max.)	Maximum allowable voltage, V DC (60°C 140°F)	Coil resistance, Ω (±10%)	Nominal operating current, mA
1 Form A 1 Form B	2 Form A					
ST1-L2-DC3V	ST2-L2-DC3V	3	2.4	4.5	40	75
ST1-L2-DC5V	ST2-L2-DC5V	5	4.0	7.5	110	47
ST1-L2-DC6V	ST2-L2-DC6V	6	4.8	9.0	155	37.5
ST1-L2-DC9V	ST2-L2-DC9V	9	7.2	13.5	360	25
ST1-L2-DC12V	ST2-L2-DC12V	12	9.6	18.0	640	18.8
ST1-L2-DC24V	ST2-L2-DC24V	24	19.2	36.0	2,400	9.8
ST1-L2-DC48V	ST2-L2-DC48V	48	38.4	72.0	10,200	4.7

## DIMENSIONS

mm inch

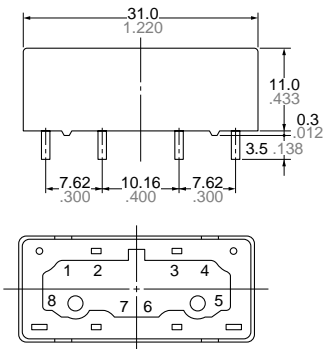

### PC board pattern (Copper-side view)

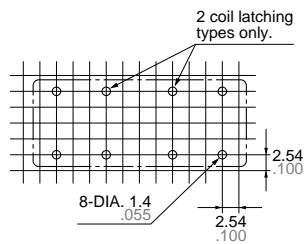

### Schematic (Bottom view) Single side stable

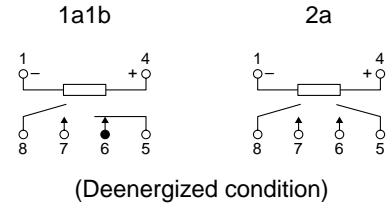

(Deenergized condition)

### 2 coil latching

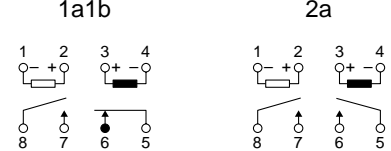

(Reset condition)

Diagram shows the "reset" position when terminals 3 and 4 are energized. Energize terminals 1 and 2 to transfer contacts.

Diagram shows the "reset" position when terminals 3 and 4 are energized. Energize terminals 1 and 2 to transfer contacts.

## REFERENCE DATA

### 1. Max. switching power

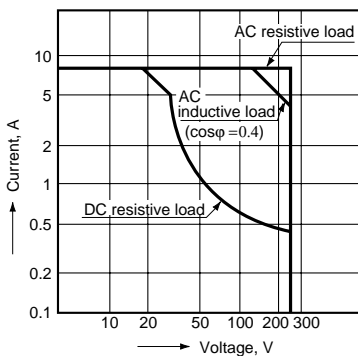

### 2. Life curve

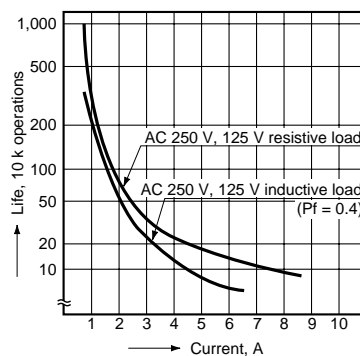

### 3. Coil temperature rise

Sample: ST1-DC24V

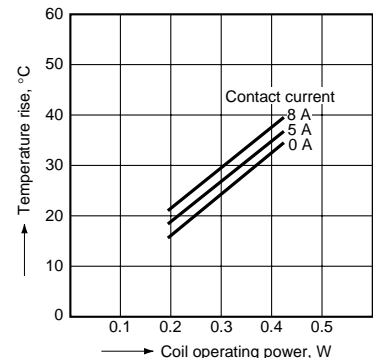

4. Influence of adjacent mounting

Sample: ST1-DC24V

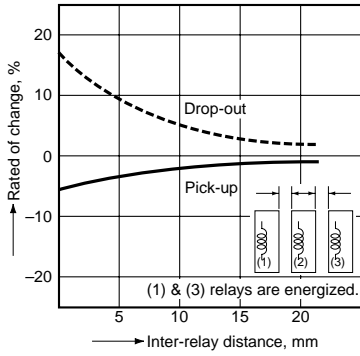

5. Max. ambient temperature by operating power

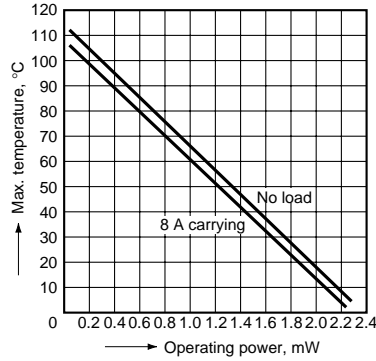

6. Contact reliability

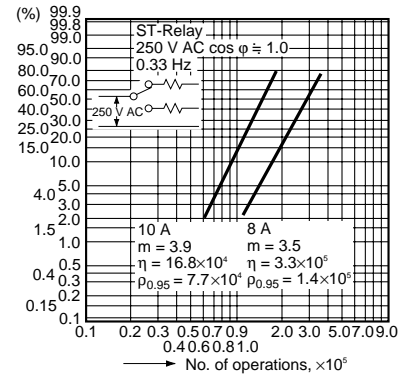

ST relay socket



ST-SS

Solder terminal socket



ST-PS

PC board terminal socket

Specifications

Breakdown voltage	4,000 Vrms Coil/Contacts 2,000 Vrms Contacts/Contacts
Insulation resistance	More than 1,000 MΩ between terminals
Heat resistance	150°C (302°F) for 1 hr
Max. continuous current	10 A
Relay insertion life	15 times

DIMENSIONS

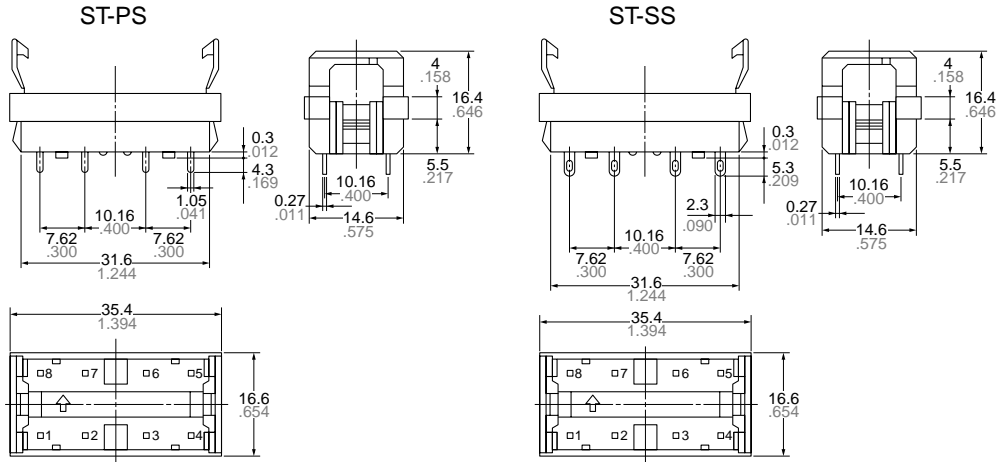

Precautions for use (socket)

1. PC board mounting method

PC board pattern

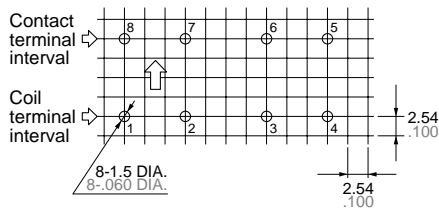

The terminal configuration is symmetrical on the left and right, so an arrow mark  $\uparrow$  is stamped on the socket to prevent mis-insertion. We recommend printing the same arrow mark  $\uparrow$  on the component mounting side (side opposite from pattern) of the PC board. In this case, the terminal configuration becomes the terminal nos. noted near the drilling holes.

2. Chassis cutout

Chassis cutting dimensions

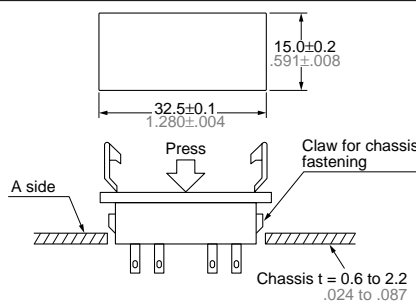

If the chassis hole is punched with a press, set so the release R on the front side (A side). The range for chassis thickness is 0.6 to 2.2 mm .024 to .087 inch .

3. Relay mounting and removal

(1) Align the directions of the relay and socket.

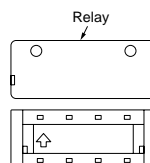

(2) Insert the relay all the way in, so it is securely in place.

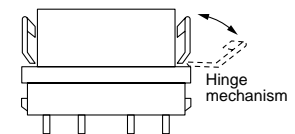

(3) Press the part indicated by A in the B direction, and fasten by placing the hook on the relay.

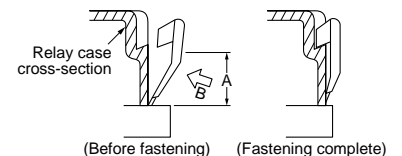

(4). When removing the relay, completely release the hooks on both sides and pull the relay out.

For Cautions for Use, see Relay Technical Information (Page 48 to 76).