

SMB Plastic-Encapsulate Diodes

Transient Voltage Suppressor Diodes

Features

- P_{PP} 600W
- V_{RWM} 5.0V- 440V
- Glass passivated chip

Applications

- Clamping Voltage

Marking

- SMBJ
XXCA/XXA/XX
XX : From 5.0 To 440

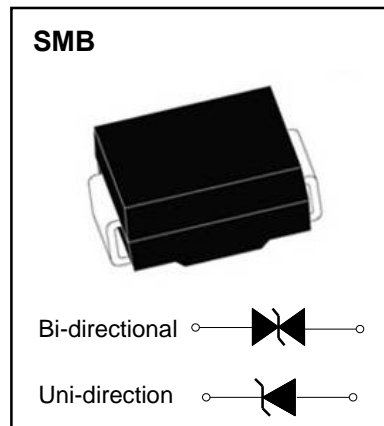

Limiting Values (Absolute Maximum Rating)

Item	Symbol	Unit	Conditions	Max
Peak power dissipation	P_{PPM}	W	with a 10/1000us waveform	600
Peak pulse current	I_{PPM}	A	with a 10/1000us waveform	See Next Table
Power dissipation	P_D	W	On infinite heat sink at $T_L=75^\circ\text{C}$	5.0
Peak forward surge current	I_{FSM}	A	8.3 ms single half sine-wave unidirectional only	100
Operating junction and storage temperature range	T_J, T_{STG}	$^\circ\text{C}$		-55 to +150

Electrical Characteristics ($T_a=25^\circ\text{C}$ Unless otherwise specified)

Item	Symbol	Unit	Conditions	Max
Maximum instantaneous forward Voltage	V_F	V	at 50A for unidirectional only	3.5/5.0
Thermal resistance	$R_{\theta JL}$	$^\circ\text{C}/\text{W}$	junction to lead	20
	$R_{\theta JA}$	$^\circ\text{C}/\text{W}$	junction to ambient	100

Notes:

- (1) Non-repetitive current pulse, per Fig. 3 and derated above $T_A = 25^\circ\text{C}$ per Fig.2.
- (2) Mounted on 0.2 x 0.2" (5.0 x 5.0 mm) copper pads to each terminal
- (3) $V_F < 3.5\text{V}$ for devices of $V_{BR} < 200\text{V}$ and $V_F < 5.0\text{V}$ for devices of $V_{BR} > 201\text{V}$

Electrical Characteristics (T_A=25°C unless otherwise noted)

Part Number (Uni)	Part Number (Bi)	Breakdown Voltage V _{BR} @I _T			I _R @V _{WM} Maximum Reverse Leakage I _R ⁽³⁾ (μA)	V _{RWM} Working Peak Reverse Voltage V _{RWM} (V)	IPP Maximum Reverse Surge Current IPP ⁽²⁾ (A)	Maximum Clamping Voltage V _c @ I _{PP} (V)
		Min(V)	Max (V)	IT ⁽¹⁾ (mA)				
SMBJ5.0	SMBJ5.0C	6.40	7.30	10	800	5.0	62.5	9.6
SMBJ5.0A	SMBJ5.0CA ⁽⁴⁾	6.40	7.07	10	800	5.0	65.2	9.2
SMBJ6.0	SMBJ6.0C	6.67	8.15	10	800	6.0	52.6	11.4
SMBJ6.0A	SMBJ6.0CA	6.67	7.37	10	800	6.0	58.3	10.3
SMBJ6.5	SMBJ6.5C	7.22	8.82	10	500	6.5	48.8	12.3
SMBJ6.5A	SMBJ6.5CA	7.22	7.98	10	500	6.5	53.6	11.2
SMBJ7.0	SMBJ7.0C	7.78	9.51	10	200	7.0	45.1	13.3
SMBJ7.0A	SMBJ7.0CA	7.78	8.60	10	200	7.0	50.0	12.0
SMBJ7.5	SMBJ7.5C	8.33	10.20	1.0	100	7.5	42.0	14.3
SMBJ7.5A	SMBJ7.5CA	8.33	9.21	1.0	100	7.5	46.5	12.9
SMBJ8.0	SMBJ8.0C	8.89	10.90	1.0	50	8.0	40.0	15.0
SMBJ8.0A	SMBJ8.0CA	8.89	9.83	1.0	50	8.0	44.1	13.6
SMBJ8.5	SMBJ8.5C	9.44	11.50	1.0	10	8.5	37.7	15.9
SMBJ8.5A	SMBJ8.5CA	9.44	10.4	1.0	10	8.5	41.7	14.4
SMBJ9.0	SMBJ9.0C	10.00	12.20	1.0	5.0	9.0	35.5	16.9
SMBJ9.0A	SMBJ9.0CA	10.00	11.10	1.0	5.0	9.0	39.0	15.4
SMBJ10	SMBJ10C	11.10	13.60	1.0	5.0	10.0	31.9	18.8
SMBJ10A	SMBJ10CA	11.10	12.30	1.0	5.0	10.0	35.3	17.0
SMBJ11	SMBJ11C	12.20	14.90	1.0	5.0	11.0	29.8	20.1
SMBJ11A	SMBJ11CA	12.20	13.50	1.0	5.0	11.0	33.0	18.2
SMBJ12	SMBJ12C	13.30	16.30	1.0	5.0	12.0	27.3	22.0
SMBJ12A	SMBJ12CA	13.30	14.70	1.0	5.0	12.0	30.2	19.9
SMBJ13	SMBJ13C	14.40	17.60	1.0	5.0	13.0	25.2	23.8
SMBJ13A	SMBJ13CA	14.40	15.90	1.0	5.0	13.0	27.9	21.5
SMBJ14	SMBJ14C	15.60	19.10	1.0	5.0	14.0	23.2	25.8
SMBJ14A	SMBJ14CA	15.60	17.20	1.0	5.0	14.0	25.9	23.2
SMBJ15	SMBJ15C	16.70	20.40	1.0	5.0	15.0	22.3	26.9
SMBJ15A	SMBJ15CA	16.70	18.50	1.0	5.0	15.0	24.6	24.4
SMBJ16	SMBJ16C	17.80	21.80	1.0	5.0	16.0	20.8	28.8
SMBJ16A	SMBJ16CA	17.80	19.70	1.0	5.0	16.0	23.1	26.0
SMBJ17	SMBJ17C	18.90	23.10	1.0	5.0	17.0	19.6	30.5
SMBJ17A	SMBJ17CA	18.90	20.90	1.0	5.0	17.0	21.7	27.6
SMBJ18	SMBJ18C	20.00	24.40	1.0	5.0	18.0	18.6	32.2
SMBJ18A	SMBJ18CA	20.00	22.10	1.0	5.0	18.0	20.5	29.2
SMBJ19	SMBJ19C	21.10	25.70	1.0	5.0	19.0	17.6	34.0
SMBJ19A	SMBJ19CA	21.10	23.30	1.0	5.0	19.0	19.5	30.8
SMBJ20	SMBJ20C	22.20	27.10	1.0	5.0	20.0	16.7	35.8
SMBJ20A	SMBJ20CA	22.20	24.50	1.0	5.0	20.0	18.5	32.4
SMBJ22	SMBJ22C	24.40	29.80	1.0	5.0	22.0	15.2	39.4
SMBJ22A	SMBJ22CA	24.40	26.90	1.0	5.0	22.0	16.9	35.5

Electrical Characteristics (T_A=25°C unless otherwise noted)

Part Number (Uni)	Part Number (Bi)	V _{BR} @I _T Breakdown Voltage V _{BR} @I _T			I _R @V _{WM} Maximum Reverse Leakage I _R ⁽³⁾ (μA)	V _{RWM} Working Peak Reverse Voltage V _{RWM} (V)	IPP Maximum Surge Current IPP ⁽²⁾ (A)	Maximum Clamping Voltage V _c @ I _{PP} (V)
		Min(V)	Max (V)	I _T ⁽¹⁾ (mA)				
SMBJ24	SMBJ24C	26.70	32.60	1.0	5.0	24.0	14.0	43.0
SMBJ24A	SMBJ24CA	26.70	29.50	1.0	5.0	24.0	15.4	38.9
SMBJ26	SMBJ26C	28.90	35.30	1.0	5.0	26.0	12.9	46.6
SMBJ26A	SMBJ26CA	28.90	31.90	1.0	5.0	26.0	14.3	42.1
SMBJ28	SMBJ28C	31.10	38.00	1.0	5.0	28.0	12.0	50.0
SMBJ28A	SMBJ28CA	31.10	34.40	1.0	5.0	28.0	13.2	45.4
SMBJ30	SMBJ30C	33.30	40.70	1.0	5.0	30.0	11.2	53.5
SMBJ30A	SMBJ30CA	33.30	36.80	1.0	5.0	30.0	12.4	48.4
SMBJ33	SMBJ33C	36.70	44.90	1.0	5.0	33.0	10.2	59.0
SMBJ33A	SMBJ33CA	36.70	40.60	1.0	5.0	33.0	11.3	53.3
SMBJ36	SMBJ36C	40.00	48.90	1.0	5.0	36.0	9.3	64.3
SMBJ36A	SMBJ36CA	40.00	44.20	1.0	5.0	36.0	10.3	58.1
SMBJ40	SMBJ40C	44.40	54.30	1.0	5.0	40.0	8.4	71.4
SMBJ40A	SMBJ40CA	44.40	49.10	1.0	5.0	40.0	9.3	64.5
SMBJ43	SMBJ43C	47.80	58.40	1.0	5.0	43.0	7.8	76.7
SMBJ43A	SMBJ43CA	47.80	52.80	1.0	5.0	43.0	8.6	69.4
SMBJ45	SMBJ45C	50.00	61.10	1.0	5.0	45.0	7.5	80.3
SMBJ45A	SMBJ45CA	50.00	55.30	1.0	5.0	45.0	8.3	72.7
SMBJ48	SMBJ48C	53.30	65.10	1.0	5.0	48.0	7.0	85.5
SMBJ48A	SMBJ48CA	53.30	58.90	1.0	5.0	48.0	7.8	77.4
SMBJ51	SMBJ51C	56.70	69.30	1.0	5.0	51.0	6.6	91.1
SMBJ51A	SMBJ51CA	56.70	62.70	1.0	5.0	51.0	7.3	82.4
SMBJ54	SMBJ54C	60.00	73.30	1.0	5.0	54.0	6.2	96.3
SMBJ54A	SMBJ54CA	60.00	66.30	1.0	5.0	54.0	6.9	87.1
SMBJ58	SMBJ58C	64.40	78.70	1.0	5.0	58.0	5.8	103.0
SMBJ58A	SMBJ58CA	64.40	71.20	1.0	5.0	58.0	6.4	93.6
SMBJ60	SMBJ60C	66.70	81.50	1.0	5.0	60.0	5.6	107.0
SMBJ60A	SMBJ60CA	66.70	73.70	1.0	5.0	60.0	6.2	96.8
SMBJ64	SMBJ64C	71.10	86.90	1.0	5.0	64.0	5.2	114.0
SMBJ64A	SMBJ64CA	71.10	78.60	1.0	5.0	64.0	5.8	103.0
SMBJ70	SMBJ70C	77.80	95.10	1.0	5.0	70.0	4.8	125.0
SMBJ70A	SMBJ70CA	77.80	86.00	1.0	5.0	70.0	5.3	113.0
SMBJ75	SMBJ75C	83.30	102.00	1.0	5.0	75.0	4.5	134.0
SMBJ75A	SMBJ75CA	83.30	92.10	1.0	5.0	75.0	5.0	121.0
SMBJ78	SMBJ78C	86.70	106.00	1.0	5.0	78.0	4.3	139.0
SMBJ78A	SMBJ78CA	86.70	95.80	1.0	5.0	78.0	4.8	126.0
SMBJ80	SMBJ80C	88.90	108.80	1.0	5.0	80.0	4.2	143.2
SMBJ80A	SMBJ80CA	88.80	97.60	1.0	5.0	80.0	4.6	129.6

Electrical Characteristics ($T_A=25^\circ\text{C}$ unless otherwise noted)

Part Number (Uni)	Part Number (Bi)	$V_{BR}@I_T$ Breakdown Voltage $V_{BR}@I_T$			$I_R@V_{WM}$ Maximum Reverse Leakage $I_R^{(3)}$ (μA)	V_{RWM} Working Peak Reverse Voltage V_{RWM} (V)	IPP Maximum Reverse Surge Current IPP ⁽²⁾ (A)	Maximum Clamping Voltage V_C @ I_{PP} (V)
		Min(V)	Max (V)	$I_T^{(1)}$ (mA)				
SMBJ85	SMBJ85C	94.40	115.00	1.0	5.0	85.0	4.0	151.0
SMBJ85A	SMBJ85CA	94.40	104.00	1.0	5.0	85.0	4.4	137.0
SMBJ90	SMBJ90C	100.00	122.00	1.0	5.0	90.0	3.7	160.0
SMBJ90A	SMBJ90CA	100.00	111.00	1.0	5.0	90.0	4.1	146.0
SMBJ100	SMBJ100C	111.00	136.00	1.0	5.0	100.0	3.3	179.0
SMBJ100A	SMBJ100CA	111.00	123.00	1.0	5.0	100.0	3.7	162.0
SMBJ110	SMBJ110C	122.00	149.00	1.0	5.0	110.0	3.1	196.0
SMBJ110A	SMBJ110CA	122.00	135.00	1.0	5.0	110.0	3.4	177.0
SMBJ120	SMBJ120C	133.00	163.00	1.0	5.0	120.0	2.8	214.0
SMBJ120A	SMBJ120CA	133.00	147.00	1.0	5.0	120.0	3.1	193.0
SMBJ130	SMBJ130CA	144.00	176.00	1.0	5.0	130.0	2.6	231.0
SMBJ130A	SMBJ130CA	144.00	159.00	1.0	5.0	130.0	2.9	209.0
SMBJ140	SMBJ140C	155.70	190.40	1.0	5.0	140.0	2.4	250.6
SMBJ140A	SMBJ140CA	155.00	171.00	1.0	5.0	140.0	2.6	226.8
SMBJ150	SMBJ150C	167.00	204.00	1.0	5.0	150.0	2.2	268.0
SMBJ150A	SMBJ150CA	167.00	185.00	1.0	5.0	150.0	2.5	243.0
SMBJ160	SMBJ160C	178.00	218.00	1.0	5.0	160.0	2.1	287.0
SMBJ160A	SMBJ160CA	178.00	197.00	1.0	5.0	160.0	2.3	259.0
SMBJ170	SMBJ170C	189.00	231.00	1.0	5.0	170.0	2.0	304.0
SMBJ170A	SMBJ170CA	189.00	209.00	1.0	5.0	170.0	2.2	275.0
SMBJ180	SMBJ180C	200.20	244.80	1.0	5.0	180.0	1.8	322.2
SMBJ180A	SMBJ180CA	200.00	220.00	1.0	5.0	180.0	2.1	291.6
SMBJ190	SMBJ190C	211.30	258.40	1.0	5.0	190.0	1.7	340.1
SMBJ190A	SMBJ190CA	211.00	232.00	1.0	5.0	190.0	1.9	307.8
SMBJ200A	SMBJ200CA	224.00	247.00	1.0	5.0	200.0	1.8	324.0
SMBJ220A	SMBJ220CA	246.00	272.00	1.0	5.0	220.0	1.7	356.0
SMBJ250A	SMBJ250CA	279.00	309.00	1.0	5.0	250.0	1.5	405.0
SMBJ300A	SMBJ300CA	335.00	371.00	1.0	5.0	300.0	1.2	486.0
SMBJ350A	SMBJ350CA	391.00	432.00	1.0	5.0	350.0	1.0	567.0
SMBJ400A	SMBJ400CA	447.00	494.00	1.0	5.0	400.0	0.9	648.0
SMBJ440A	SMBJ440CA	492.00	543.00	1.0	5.0	440.0	0.8	713.0

Notes:

- (1) $t_p \leq 50\text{ms}$ Pulse test: $t_p \leq 50\text{ms}$
- (2) Surge current waveform per Fig. 3 and derated per Fig.2.
- (3) For bi-directional types having V_{WM} of 10 V and less, the I_R limit is doubled
- (4) For the bi-directional SMBJ5.0CA, the maximum V_{BR} is 7.25 V

Typical Characteristics

FIG1: Peak Pulse Power Rating Curve

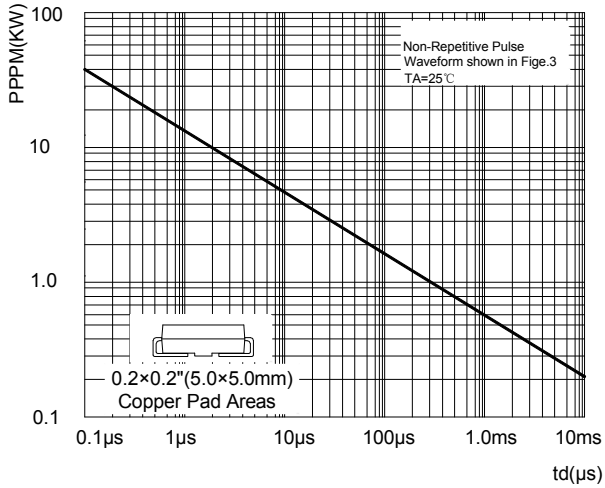

FIG2: Pulse Power or Current vs. Initial Junction Temperature

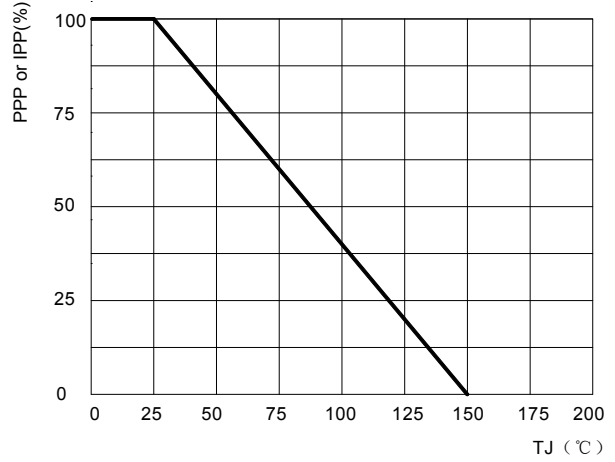

FIG3: Pulse Waveform

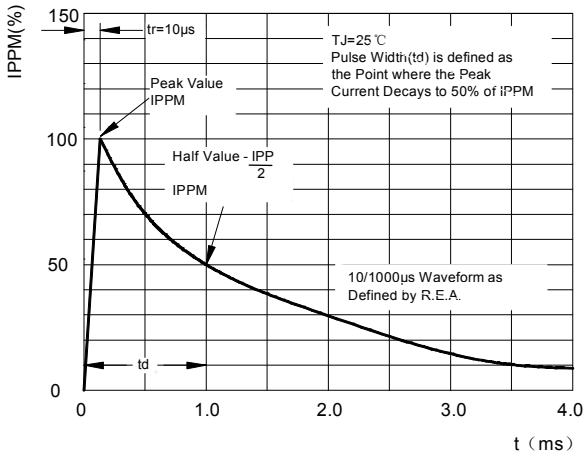

FIG4: Typical Transient Thermal Impedance

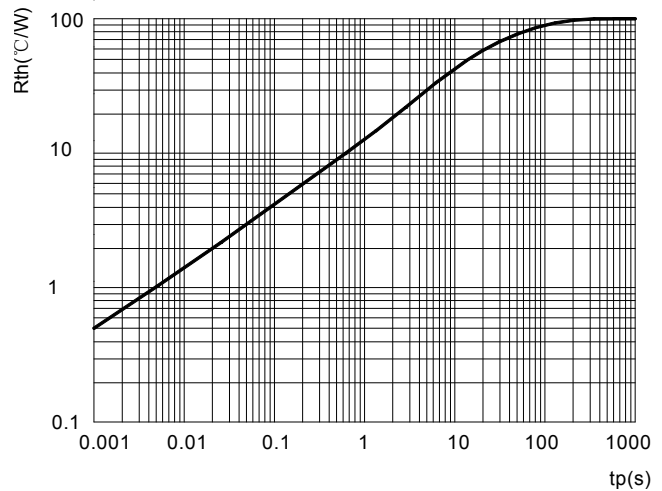

FIG5: Maximum Non-Repetitive Surge Current

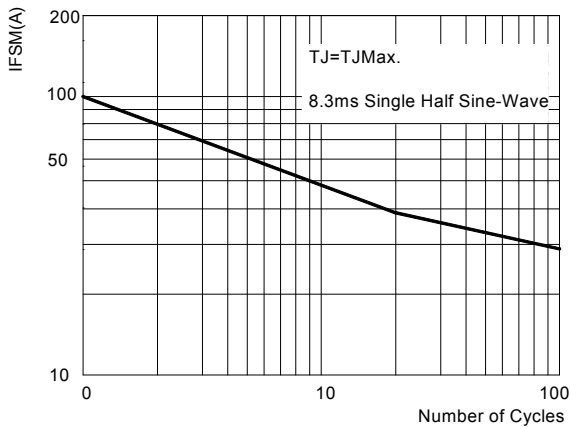
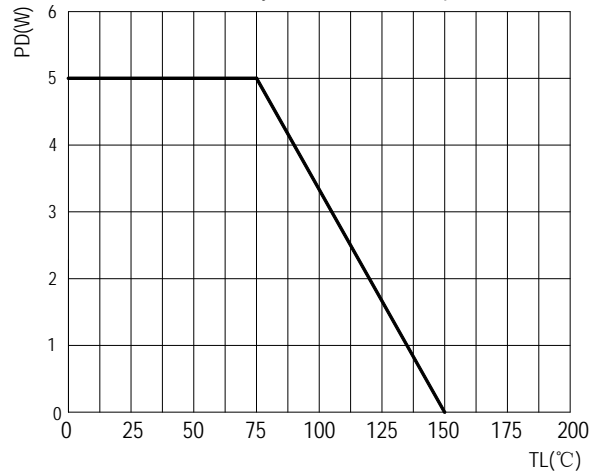
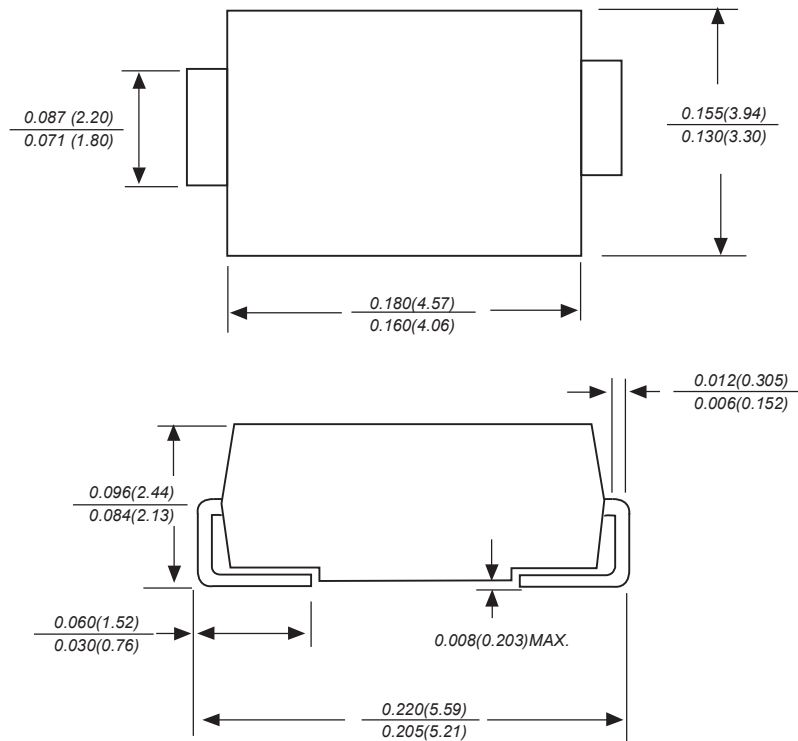

FIG6: Steady State Power Dissipation



SMB Package Outline Dimensions



Dimensions in inches and (millimeters)

SMB Suggested Pad Layout

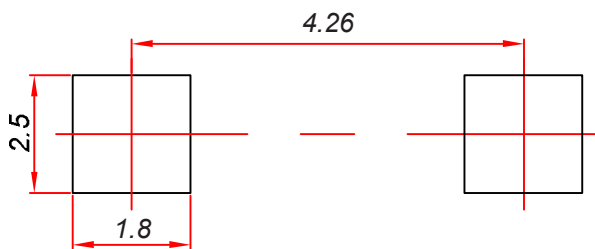

Note:

1. Controlling dimension: in millimeters.
2. General tolerance: $\pm 0.05mm$.
3. The pad layout is for reference purposes only.

NOTICE

JSMD reserve the right to make modifications, enhancements, improvements, corrections or other changes without further notice to any product herein. JSMD does not assume any liability arising out of the application or use of any product described herein.

Reel Taping Specifications For Surface Mount Devices–SMB

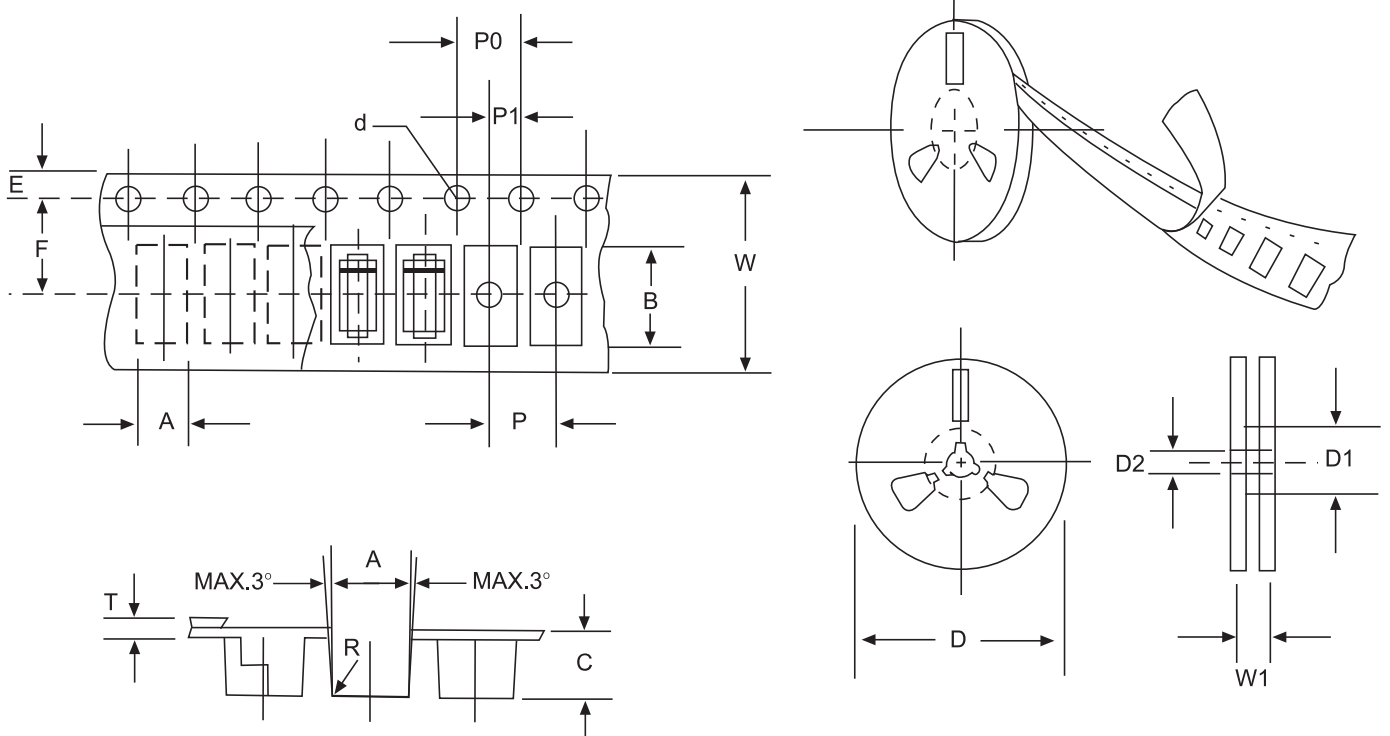

FIG:CONFIGURATION OF AXIAL TAPING

ITEM	SYMBOL	SMB mm(inch)
Carrier width	A	4.09±0.1(0.161±0.004)
Carrier length	B	5.82±0.1(0.229±0.004)
Carrier depth	C	3.33±0.1(0.131±0.004)
Sprocket hole	d	1.55±0.05(0.061±0.0002)
Reel outside diameter	D	330/178±2.0(13/7.0±0.79)
Reel inner diameter	D1	8.0±0.2(0.315±0.008)
Feed hole diameter	D2	13±0.5(0.512±0.020)
Sprocket hole position	E	1.75±0.1(0.069±0.004)
Punch hole position	F	5.65±0.05(0.222±0.002)
Punch hole pitch	P	8.0±0.1(0.315±0.004)
Sprocket hole pitch	P0	4.0±0.1(0.157±0.004)
Embossment center	P1	2.0±0.1(0.079±0.004)
Total tape thickness	T	0.32±0.1(0.013±0.004)
Tape width	W	12.0±0.2(0.472±0.008)
Reel width	W1	16.8±2.0(0.661±0.079)

NOTE:Devices are packde in accordance with EIA standard RS-481-A and specification given above.