

1.5 AMP NEGATIVE ADJUSTABLE VOLTAGE REGULATOR APPROVED TO DESC DRAWING 7703406



**Three Terminal, Precision Adjustable
 Negative Voltage Regulator In Hermetic
 Style Packages (LM137A)**

FEATURES

- Similar To Industry Standard LM137A
- Approved To DESC Standardized Military Drawing Number 7703406
- Built In Thermal Overload Protection
- Short Circuit Current Limiting
- Available In Six Package Styles
- Maximum Output Voltage Tolerance Is Guaranteed to $\pm 1\%$

DESCRIPTION

These three terminal negative regulators are supplied in hermetically sealed packages. All protective features are designed into the circuit, including thermal shutdown, current-limiting, and safe-area control. With heat sinking, these devices can deliver up to 1.5 amps of output current. The LCC-20 device is limited to .5 amps. The unit also features output voltages that can be fixed from -1.2 volts to -37 volts using external resistors.

ABSOLUTE MAXIMUM RATINGS $T_c @ 25^\circ\text{C}$

Power Dissipation	
Case 2	1.1 W
Case-All Others.	20 W
Input - Output Voltage Differential	40 V
Operating Junction Temperature Range	- 55°C to + 150°C
Storage Temperature Range	- 65°C to + 150°C
Lead Temperature (Soldering 10 seconds)	300°C
Thermal Resistance, Junction to Case:	
Case 2, LCC-20	17°C/W
Case U & M, TO-257 (Isol) and SMD-3	4.2°C/W
Case T&N, TO-257 (Non-Isol) and SMD-1	3.5°C/W
Case Y, TO-3	3.0°C/W
Maximum Output Current:	
Case 25 A
Case-All Others.	1.5A
<u>Recommended Operating Conditions:</u>	
Output Voltage Range	-1.2 to -37 VDC
Ambient Operating Temperature Range (T_A).	- 55°C to + 125°C
Input Voltage Range	-4.25 to -41.25 VDC

3.5



ELECTRICAL CHARACTERISTICS -55°C T_A 125°C, $I_L = 8mA$ (unless otherwise specified)
OM1325NTM, OM1325STM, OM1325NKM, OM1325SMM, OM1325NMM

Parameter	Symbol	Test Conditions	Min.	Max.	Unit
Reference Voltage	V_{REF}	$ V_{DIFF} = 3.0V, T_A = 25^\circ C$ $ V_{DIFF} = 3.0V$ $ V_{DIFF} = 40V$	-1.262 -1.280 -1.280	-1.238 -1.220 -1.220	V
Line Regulation (Note 1)	R_{LINE}	3.0 V $ V_{DIFF} $ 40V, $T_A = 25^\circ C$ 3.0V $ V_{DIFF} $ 40V	-4.5 -13.8	4.5 13.8	mV
Load Regulation (Note 1)	R_{LOAD}	$ V_{DIFF} = 5V, 8mA I_L 1.5A$ $ V_{DIFF} = 12V, 8mA I_L 1.5A, T_A = 25^\circ C$ $ V_{DIFF} 40V, 8mA I_L 1.5A, T_A = 25^\circ C$ $ V_{DIFF} = 40V, 8mA I_L 1.5A$	-25 -25 -25 -50	25 25 25 50	mV
Thermal Regulation	V_{RTH}	$V_{in} = -14.6V, I_L = 1.5A$ $P_d = 20$ Watts, $t = 10$ ms, $T_A = 25^\circ C$	-5	5	mV
Ripple Rejection (Note 2)	R_N	$f = 120$ Hz, $V_{out} = V_{ref}$ $C_{Adj} = 10 \mu F$	66		dB
Adjustment Pin Current	I_{Adj}	$ V_{DIFF} = 3.0V$ $ V_{DIFF} = 40V$		100 100	μA
Adjustment Pin Current Change	I_{Adj} (line)	3V $ V_{DIFF} $ 40V	-5	5	μA
	I_{Adj} (load)	$ V_{DIFF} = 5V, 8mA I_L 1.5A$	-5	5	μA
Minimum Load Current	I_{Lmin}	$ V_{DIFF} = 3.0V, V_{out} = -1.4V$ (forced) $ V_{DIFF} = 10V, V_{out} = -1.4V$ (forced) $ V_{DIFF} = 40V, V_{out} = -1.4V$ (forced)		3.0 3.0 5.0	mA
Current Limit (Note 2)	I_{CL}	$ V_{DIFF} 5V$ $ V_{DIFF} = 40V, T_A = 25^\circ C$	1.5 0.24	3.5 1.2	A

Notes:

1. Load and Line Regulation are specified at a constant junction temperature. Pulse testing with low duty cycle is used. Changes in output voltage due to heating effects must be taken into account separately.
2. If not tested, shall be guaranteed to the specified limits.
3. The • denotes the specifications which apply over the full operating temperature range.

3.5

PART NUMBER DESIGNATOR		
Standard Military Drawing Number	Omnirel Part Number	Omnirel Package Designation
7703406M 7703406U 7703406T 7703406Y 7703406N 77034062	OM1325SMM OM1325STM OM1325NTM OM1325NKM OM1325NMM OM1325N2M	SMD-3 TO-257 (Isolated) TO-257 (non-Isolated) TO-3 SMD-1 LCC-20

ELECTRICAL CHARACTERISTICS -55°C T_A 125°C, I_L = 8mA (unless otherwise specified)

OM1325N2M

Parameter	Symbol	Test Conditions	Min.	Max.	Unit
Reference Voltage	V _{REF}	V _{DIFF} = 3.0V, T _A = 25°C V _{DIFF} = 3.0V V _{DIFF} = 40V	-1.262 -1.280 -1.280	-1.238 -1.220 -1.220	V
Line Regulation (Note 1)	R _{LINE}	3.0 V V _{DIFF} 40V, T _A = 25°C 3.0V V _{DIFF} 40V	-4.5 -13.8	4.5 13.8	mV
Load Regulation (Note 1)	R _{LOAD}	V _{DIFF} = 5V, 8mA I _L 200 mA V _{DIFF} = 15V, 8mA I _L 200m, AT _A = 25°C V _{DIFF} 40V, 8mA I _L 150 mA, AT _A = 25°C V _{DIFF} = 40V, 8mA I _L 50 mA	-25 -25 -25 -50	25 25 25 50	mV
Thermal Regulation	V _{RTH}	V _{in} = -16.25V, I _L = 330 mA P _d = 5 Watts, t = 10 ms, T _A = 25°C	-5	5	mV
Ripple Rejection (Note 2)	R _N	f = 120 Hz, V _{out} = V _{ref} C _{Adj} = 10 μF	66		dB
Adjustment Pin Current	I _{Adj}	V _{DIFF} = 3.0V V _{DIFF} = 40V		100 100	μA
Adjustment Pin Current Change	I _{Adj} (line)	3V V _{DIFF} 40V	-5	5	μA
	I _{Adj} (load)	V _{DIFF} = 5V, 8mA I _L 500 mA	-5	5	μA
Mimumin Load Current	I _{Lmin}	V _{DIFF} = 3.0V, V _{out} = -1.4V (forced) V _{DIFF} = 10V, V _{out} = -1.4V (forced) V _{DIFF} = 40V, V _{out} = -1.4V (forced)		3.0 3.0 5.0	mA
Current Limit (Note 2)	I _{CL}	V _{DIFF} 5V V _{DIFF} = 40V, T _A = 25°C	0.5 0.15	1.8 0.65	A

Notes:

1. Load and Line Regulation are specified at a constant junction temperature. Pulse testing with low duty cycle is used. Changes in output voltage due to heating effects must be taken into account separately.
2. If not tested, shall be guaranteed to the specified limits.
3. The • denotes the specifications which apply over the full operating temperature range.

TYPICAL APPLICATION

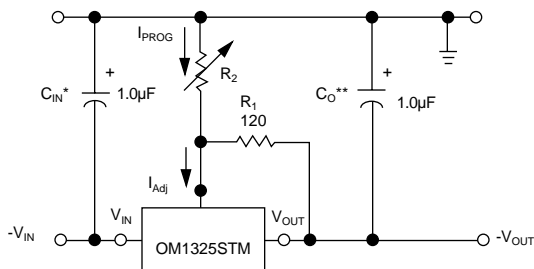

* C_{in} is required if regulator is located more than 4 inches from power supply filter. A 1 μF solid tantalum or 10 μF aluminum electrolytic is recommended.

** C_o is necessary for stability. A 1 μF solid tantalum or 10 μF aluminum electrolytic is recommended.

$$V_{out} = -1.25 V \left(1 + \frac{R_2}{R_1} \right)$$

3.5

MECHANICAL OUTLINE

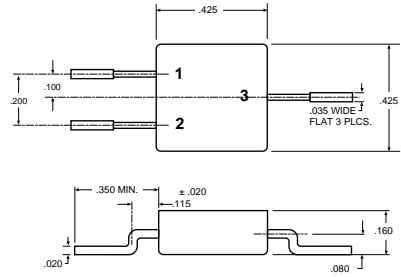
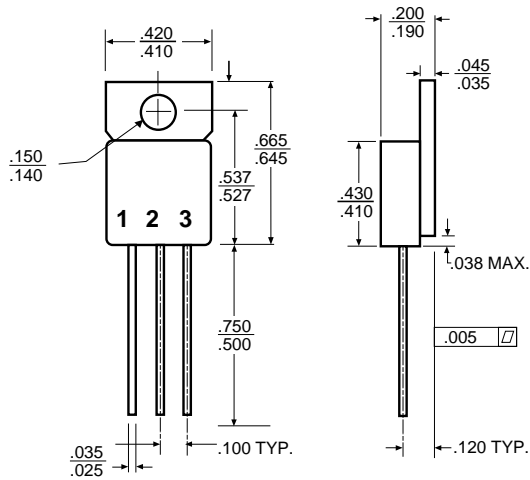

OM1325SMM
 Front View
 Pin 1 - Adjust
 Pin 2 - Output
 Pin 3 - Input
 Case - Isolated

OM1325STM
 Isolated
 Front View
 Pin 1 - Adjust
 Pin 2 - Input
 Pin 3 - Output
 Tab - Isolated

OM1325NTM
 Non-Isolated
 Front View
 Pin 1 - Adjust
 Pin 2 - Input
 Pin 3 - Output
 Tab - Input

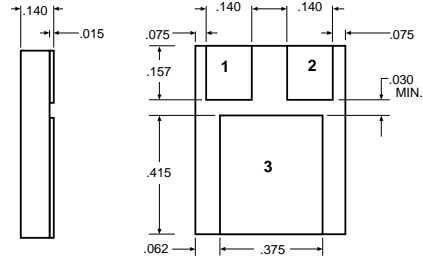

OM1325NMM
 Pin 1 - Adjust
 Pin 2 - Output
 Pin 3 - Input

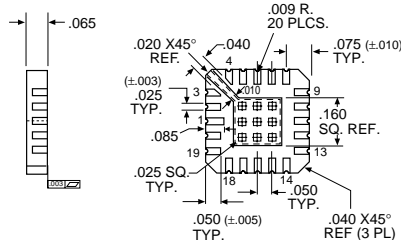
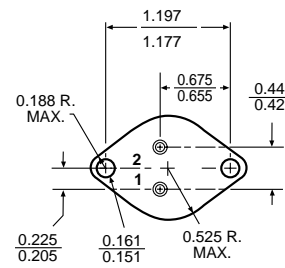
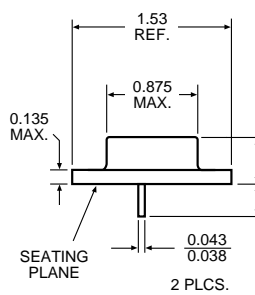

OM1325N2M

- | | |
|-------------------------------|-----------------|
| Pin 1 V_{OUT} | Pin 11 V_{IN} |
| Pin 2 $V_{OUT}(\text{Sense})$ | Pin 12 NC |
| Pin 3 NC | Pin 13 NC |
| Pin 4 NC | Pin 14 NC |
| Pin 5 NC | Pin 15 NC |
| Pin 6 NC | Pin 16 ADJUST |
| Pin 7 NC | Pin 17 NC |
| Pin 8 NC | Pin 18 NC |
| Pin 9 NC | Pin 19 NC |
| Pin 10 NC | Pin 20 NC |

OM1325NKM
 Pin 1 - Adjust
 Pin 2 - Output
 Case - Input

3.5

For additional information please see the mechanical outline section.