

Coaxial Low Noise Amplifier

ZX60-06203LN+

50Ω 6 to 20 GHz

The Big Deal

- Low noise figure, 2.8 dB typ, 6 to 18 GHz
- Excellent gain flatness
- High gain broadband performance
- Voltage regulated internally and reverse voltage protected
- Excellent directivity, 20 dB typ



CASE STYLE: GC957

Product Overview

Mini-Circuits' ZX60-06203LN+ is a wideband low noise connectorized amplifier providing a unique combination of low noise figure, high IP3 and flat gain over a very wide frequency range, supporting a wide range of sensitive, high-dynamic range receiver applications and many systems where high performance over wideband is needed. This design operates on a single 5 V supply and comes in a rugged, compact unibody case (0.74 x 0.75 x 0.46") with SMA connectors, making it an excellent candidate for tough operating conditions and crowded system layouts.

Key Features

Feature	Advantages
Ultra-wideband with excellent gain flatness, ± 1.6 dB for 8 - 18 GHz	Enables a single amplifier to be used in a wide range of applications including EW and communication systems instrumentation and more.
Low noise over the whole band	Enables lower system noise figure performance.
High gain, 18 dB typ.	Reduces the number of gain stages, lowering component count and overall system cost.
High IP3 +26 dBm typ over 6 to 12 GHz +29 dBm typ over 12 to 20 GHz	The combination of low noise and high IP3 makes the ZX60-06203LN+ ideal for use in low noise receiver front end (RFE) as it gives the user the advantages of sensitivity and two-tone IM performance at both ends of the dynamic range.
Excellent Directivity (Isolation-Gain), 20 dB typ.	Buffer amplifier reduces need for adjacent circuits
Low operating voltage, 5V	The amplifier features low operating voltage
Rugged, unibody construction	Mini-Circuits unibody construction integrates the RF connector into the case body, providing high reliability and excellent survivability in critical applications.

Notes

- A. Performance and quality attributes and conditions not expressly stated in this specification document are intended to be excluded and do not form a part of this specification document.
B. Electrical specifications and performance data contained in this specification document are based on Mini-Circuit's applicable established test performance criteria and measurement instructions.
C. The parts covered by this specification document are subject to Mini-Circuits standard limited warranty and terms and conditions (collectively, "Standard Terms"); Purchasers of this part are entitled to the rights and benefits contained therein. For a full statement of the Standard Terms and the exclusive rights and remedies thereunder, please visit Mini-Circuits' website at www.minicircuits.com/MCLStore/terms.jsp



Coaxial Low Noise Amplifier

ZX60-06203LN+

50Ω 6 to 20 GHz

Features

- Low noise figure, 2.8 dB typ, over 6 to 18 GHz
- Excellent Gain flatness, ±1.6 dB over 8 to 18 GHz
- High gain 18 dB typ. 8-18 GHz
- Medium power with good linearity, 15.5 dBm typ P1dB, 27 dBm typ OIP3
- Excellent directivity, 20 typ

Applications

- Microwave point to point radios
- Military EW and radar
- Satellite Systems



Generic photo used for illustration purposes only

CASE STYLE: GC957

Connectors Model
SMA ZX60-06203LN+

+RoHS Compliant

The +Suffix identifies RoHS Compliance. See our web site for RoHS Compliance methodologies and qualifications

Electrical Specifications at 25°C and 5V, unless noted

Parameter	Condition (GHz)	V _{DD} =5.0			Units
		Min.	Typ.	Max.	
Frequency Range		6.0		20.0	GHz
Noise Figure	6.0-8.0		2.5		dB
	8.0-12.0		2.6		
	12.0-16.0		2.9		
	16.0-18.0		2.8		
	18.0-20.0		3.4		
Gain	6.0-8.0		16.9		dB
	8.0-12.0		18.3		
	12.0-16.0	13.0	18.6		
	16.0-18.0	15.0	18.4		
	18.0-20.0		15.3		
Input Return Loss	6.0-8.0		14.0		dB
	8.0-12.0		13.0		
	12.0-16.0		7.5		
	16.0-18.0		10.0		
	18.0-20.0		7.5		
Output Return Loss	6.0-8.0		14.0		dB
	8.0-12.0		10.5		
	12.0-16.0		12.2		
	16.0-18.0		12.0		
	18.0-20.0		10.0		
Output Power at 1dB Compression ⁽¹⁾	6.0-8.0		15.4		dBm
	8.0-12.0		16.0		
	12.0-16.0		16.0		
	16.0-18.0		15.0		
	18.0-20.0		14.7		
Output IP ₃ ²	6.0-8.0		26.3		dBm
	8.0-12.0		26.2		
	12.0-16.0		27.4		
	16.0-18.0		29.3		
	18.0-20.0		29.7		
Device Operating Voltage (V _{DD})	—	4.9	5.0	6.0	V
Device Operating Current (I _{DD})			128	150	mA

1. Current increases at P1dB
2. OIP3 measured with 0 dBm tones and 1 MHz spacing.

Notes

- A. Performance and quality attributes and conditions not expressly stated in this specification document are intended to be excluded and do not form a part of this specification document.
- B. Electrical specifications and performance data contained in this specification document are based on Mini-Circuit's applicable established test performance criteria and measurement instructions.
- C. The parts covered by this specification document are subject to Mini-Circuits standard limited warranty and terms and conditions (collectively, "Standard Terms"); Purchasers of this part are entitled to the rights and benefits contained therein. For a full statement of the Standard Terms and the exclusive rights and remedies thereunder, please visit Mini-Circuits' website at www.minicircuits.com/MCLStore/terms.jsp



www.minicircuits.com P.O. Box 350166, Brooklyn, NY 11235-0003 (718) 934-4500 sales@minicircuits.com

REV. OR
M171286
ZX60-06203LN+
ED-15070802
DJ/CP/AM
190614
Page 2 of 4

Absolute Maximum Ratings³

Parameter	Ratings
Operating Temperature (ground lead)	-40°C to 85°C
Storage Temperature	-55°C to 100°C
Total Power Dissipation	0.7 W
Input Power (CW), Vd=5V	17 dBm
DC Voltage	6V

3. Permanent damage may occur if any of these limits are exceeded.
Electrical maximum ratings are not intended for continuous normal operation.

Outline Drawing

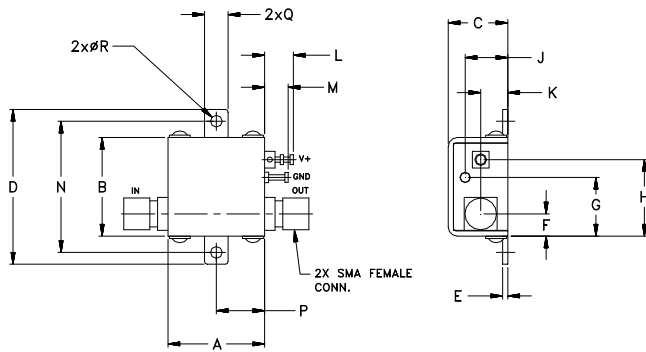

! NOTE: When soldering the DC connections, caution must be used to avoid overheating the DC terminal. See Application Note. [AN-40-010](#).

Outline Dimensions (inch/mm)

A	B	C	D	E	F	G	H	J	K	L	M	N	P	Q	R	wt
.74	.75	.46	1.18	.04	.17	.45	.59	.33	.21	.22	.18	1.00	.37	.18	.106	grams
18.80	19.05	11.68	29.97	1.02	4.32	11.43	14.99	8.38	5.33	5.59	4.57	25.40	9.40	4.57	2.69	23.0

Notes

- A. Performance and quality attributes and conditions not expressly stated in this specification document are intended to be excluded and do not form a part of this specification document.
- B. Electrical specifications and performance data contained in this specification document are based on Mini-Circuit's applicable established test performance criteria and measurement instructions.
- C. The parts covered by this specification document are subject to Mini-Circuits standard limited warranty and terms and conditions (collectively, "Standard Terms"); Purchasers of this part are entitled to the rights and benefits contained therein. For a full statement of the Standard Terms and the exclusive rights and remedies thereunder, please visit Mini-Circuits' website at www.minicircuits.com/MCLStore/terms.jsp

FREQUENCY (MHz)	GAIN (dB)	DIRECTIVITY (dB)	RETURN LOSS 5V		POWER OUT @1 dB COMPR. (dBm)	NF (dB)	IP3 (dBm)
	5V	5V	IN	OUT	5V	5V	5V
6000	16.25	34.04	13.96	12.17	14.50	2.72	25.99
6500	16.51	33.56	14.59	12.34	14.99	2.61	25.99
7000	16.76	33.13	15.15	12.53	15.41	2.57	25.94
8000	17.24	32.48	16.15	13.10	15.82	2.42	25.94
9000	17.75	32.00	17.17	13.48	15.89	2.55	26.03
10000	18.17	30.58	18.95	13.16	16.22	2.47	25.88
11000	18.47	28.96	17.51	12.19	16.50	2.56	25.98
12000	18.52	28.34	10.26	11.12	16.55	2.74	26.41
13000	18.31	27.00	6.75	12.02	16.40	2.92	26.82
14000	18.24	25.23	5.78	16.09	16.12	3.01	27.28
15000	18.65	22.75	6.64	25.26	15.54	2.90	27.85
16000	19.16	19.86	10.71	24.26	15.31	2.70	28.25
17000	18.67	18.90	14.65	13.53	14.85	2.73	28.31
18000	16.94	19.94	9.62	10.07	14.58	2.90	27.90
19000	15.23	20.74	8.02	9.02	14.67	3.39	27.85
20000	14.38	21.05	7.63	9.53	14.40	3.78	27.96

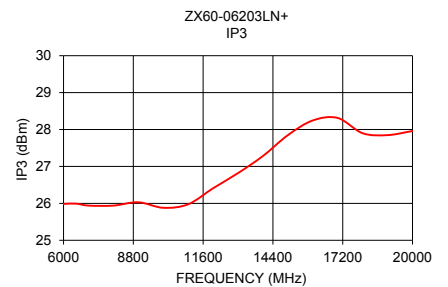
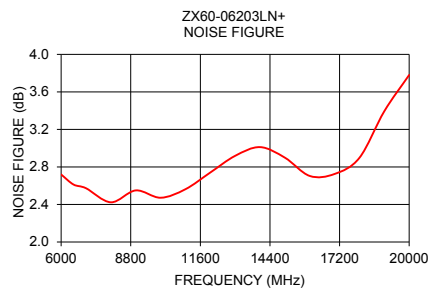
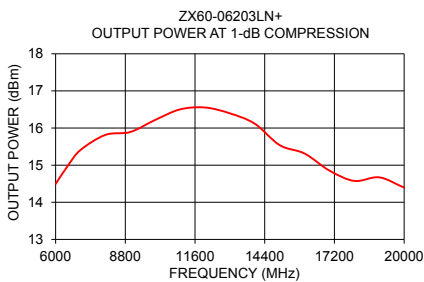
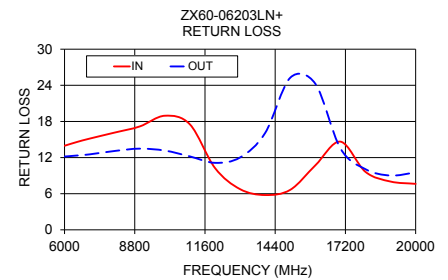
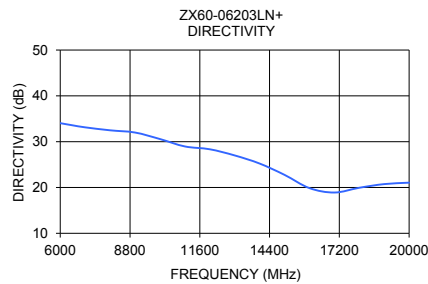
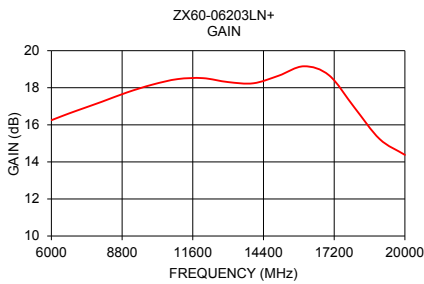

Notes

- A. Performance and quality attributes and conditions not expressly stated in this specification document are intended to be excluded and do not form a part of this specification document.
- B. Electrical specifications and performance data contained in this specification document are based on Mini-Circuit's applicable established test performance criteria and measurement instructions.
- C. The parts covered by this specification document are subject to Mini-Circuits standard limited warranty and terms and conditions (collectively, "Standard Terms"); Purchasers of this part are entitled to the rights and benefits contained therein. For a full statement of the Standard Terms and the exclusive rights and remedies thereunder, please visit Mini-Circuits' website at www.minicircuits.com/MCLStore/terms.jsp

