

Data sheet | Item number: 2022-1602

2-pin carrier terminal block; for DIN-rail 35 x 15 and 35 x 7.5; orange

www.wago.com/2022-1602

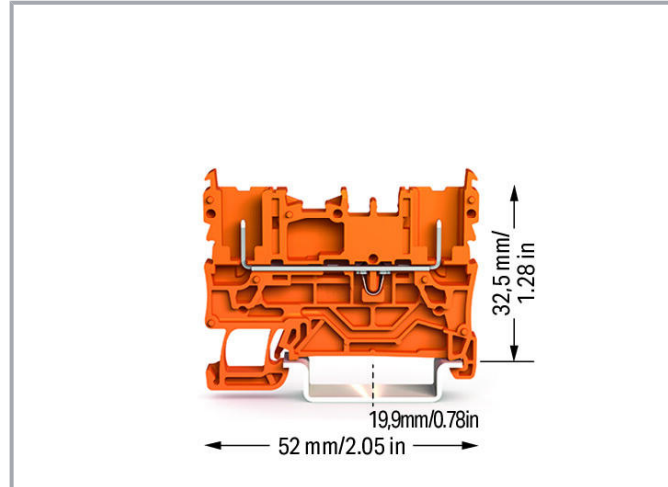

Data

Electrical data

Ratings per IEC/EN

Ratings per	IEC/EN 60947-7-1
Nominal voltage (III/3)	690 V
Rated surge voltage (III/3)	6 kV
Rated current	24 A
Rated current 2	28 A
Legend (ratings)	(III / 3) ≙ Overvoltage category III / Pollution degree 3

Ratings per UL

Approvals per	UL 1059
Rated voltage UL (Use Group B)	600 V

Subject to changes. Please also observe the further product documentation!

WAGO GmbH & Co. KG
Hansastr. 27
32423 Minden
Phone: +49571 887-0 | Fax: +49571 887-169
Email: info.de@wago.com | Web: www.wago.com

Do you have any questions about our products?
We are always happy to take your call at +49 (571) 887-44222.



Rated current UL (Use Group B)	20 A
Rated voltage UL (Use Group C)	600 V
Rated current UL (Use Group C)	20 A

Ratings per CSA

Approvals per	C22.2 No 158
Rated voltage CSA (Use Group C)	600 V
Rated current CSA (Use Group C)	20 A

Physical data

Width	5.2 mm / 0.205 inch
Height	52 mm / 2.047 inch
Depth from upper edge of DIN-rail	32.5 mm / 1.28 inch

Mechanical data

Design	horizontal type
Mounting type	DIN-35 rail
Marking level	Center/side marking

Material data

Note on material data	Information on material data can be found here
Color	orange
Insulation material	Polyamide (PA66)
Flammability class per UL94	V0
Weight	5.5 g

Commercial data

PU (SPU)	50 Stück
Packaging type	box
Country of origin	CN
Customs tariff number	85366990990

Approvals / Certificates

Country specific Approvals

Logo	Approval	Additional Approval Text	Certificate name

Subject to changes. Please also observe the further product documentation!



CCA
DEKRA Certification B.V.

C22.2 No. 158

2437422



CCA
DEKRA Certification B.V.

EN 60947

NTR CCA
NL-7864

KEMA/KEUR
DEKRA Certification B.V.



EN 60947

71-
116567

UL-Approvals



Logo	Approval	Additional Approval Text	Certificate name
	UL Underwriters Laboratories Inc.	UL 1059	E45172

Counterpart

	Item no.2022-101 1-conductor female connector; Push-in CAGE CLAMP®; 4 mm²; Pin spacing 5.2 mm; 1-pole; 4,00 mm²; gray	www.wago.com/2022-101
	Item no.2022-101/000-012 1-conductor female connector; Push-in CAGE CLAMP®; 4 mm²; Pin spacing 5.2 mm; 1-pole; 4,00 mm²; orange	www.wago.com/2022-101/000-012

Required accessories

End plate

	Item no.: 2022-1691 End plate; 1 mm thick; gray	www.wago.com/2022-1691
	Item no.: 2022-1692 End plate; 1 mm thick; orange	www.wago.com/2022-1692

Optional accessories

Marking accessories

Subject to changes. Please also observe the further product documentation!

WAGO GmbH & Co. KG
Hansastr. 27
32423 Minden
Phone: +49571 887-0 | Fax: +49571 887-169
Email: info.de@wago.com | Web: www.wago.com

Do you have any questions about our products?
We are always happy to take your call at +49 (571) 887-44222.

Marking strip

	Item no.: 2009-110 Marking strips; for Smart Printer; on reel; not stretchable; plain; snap-on type; white	www.wago.com/2009-110
--	--	--

Marker carrier

	Item no.: 2009-198 Adaptor; gray	www.wago.com/2009-198
---	--	--

	Item no.: 2002-161 Adaptor; gray	www.wago.com/2002-161
---	--	--

Marker

	Item no.: 2009-145 Mini-WSB Inline; for Smart Printer; 1700 pieces on roll; stretchable 5 - 5.2 mm; plain; snap-on type; white	www.wago.com/2009-145
--	--	--

	Item no.: 2009-115 WMB-Inline; for Smart Printer; 1500 pieces on roll; stretchable 5 - 5.2 mm; plain; snap-on type; white	www.wago.com/2009-115
--	---	--

	Item no.: 248-501 Mini-WSB marking card; as card; not stretchable; plain; snap-on type; white	www.wago.com/248-501
--	---	--

	Item no.: 793-501 WMB marking card; as card; not stretchable; plain; snap-on type; white	www.wago.com/793-501
--	--	--

	Item no.: 793-5501 WMB marking card; as card; for terminal block width 5 - 17.5 mm; stretchable 5 - 5.2 mm; plain; snap-on type; white	www.wago.com/793-5501
--	--	--

Group marker carrier

	Item no.: 2009-193 Group marker carrier; gray	www.wago.com/2009-193
---	---	--

	Item no.: 2009-192 Group marker carrier; gray	www.wago.com/2009-192
---	---	--

	Item no.: 2009-191 Group marker carrier; gray	www.wago.com/2009-191
---	---	--

Jumpers

Jumper

	Item no.: 2002-402 Jumper; 2-way; insulated; light gray	www.wago.com/2002-402
--	---	--

	Item no.: 2002-402/000-005 Jumper; 2-way; insulated; red	www.wago.com/2002-402/000-005
---	--	--

	Item no.: 2002-400 Continuous jumper; 2-way; insulated; light gray	www.wago.com/2002-400
--	--	--

Item no.: 2002-403

Subject to changes. Please also observe the further product documentation!

Jumper; 3-way; insulated; light gray

www.wago.com/2022-403



Item no.: 2002-404/000-005

Jumper; 4-way; insulated; red

www.wago.com/2002-404/000-005



Item no.: 2002-403/000-006

Jumper; 3-way; insulated; blue

www.wago.com/2002-403/000-006



Item no.: 2002-404/000-006

Jumper; 4-way; insulated; blue

www.wago.com/2002-404/000-006



Item no.: 2002-403/000-005

Jumper; 3-way; insulated; red

www.wago.com/2002-403/000-005

Item no.: 2002-405/000-005

Jumper; 5-way; insulated; red

www.wago.com/2002-405/000-005



Item no.: 2002-402/000-006

Jumper; 2-way; insulated; blue

www.wago.com/2002-402/000-006

Item no.: 2002-405/000-006

Jumper; 5-way; insulated; blue

www.wago.com/2002-405/000-006

Item no.: 2002-404

Jumper; 4-way; insulated; light gray

www.wago.com/2002-404

Item no.: 2002-406/000-006

Jumper; 6-way; insulated; blue

www.wago.com/2002-406/000-006

Item no.: 2002-406/000-005

Jumper; 6-way; insulated; red

www.wago.com/2002-406/000-005



Item no.: 2002-406/020-000

Delta jumper; insulated; light gray

www.wago.com/2002-406/020-000

Item no.: 2002-405

Jumper; 5-way; insulated; light gray

www.wago.com/2002-405

Item no.: 2002-407/000-005

Jumper; 7-way; insulated; red

www.wago.com/2002-407/000-005



Item no.: 2002-408

Subject to changes. Please also observe the further product documentation!

WAGO GmbH & Co. KG

Hansastr. 27

32423 Minden

Phone: +49571 887-0 | Fax: +49571 887-169

Email: info.de@wago.com | Web: www.wago.com









Do you have any questions about our products?

We are always happy to take your call at +49 (571) 887-44222.









	Jumper; 8-way; insulated; light gray	www.wago.com/2002-408
	Item no.: 2002-408/000-006 Jumper; 8-way; insulated; blue	www.wago.com/2002-408/000-006
	Item no.: 2002-405/011-000 Star point jumper; 3-way; insulated; light gray	www.wago.com/2002-405/011-000
	Item no.: 2002-407/000-006 Jumper; 7-way; insulated; blue	www.wago.com/2002-407/000-006
	Item no.: 2002-408/000-005 Jumper; 8-way; insulated; red	www.wago.com/2002-408/000-005
	Item no.: 2002-407 Jumper; 7-way; insulated; light gray	www.wago.com/2002-407
	Item no.: 2002-406 Jumper; 6-way; insulated; light gray	www.wago.com/2002-406
	Item no.: 2002-410/000-005 Jumper; 10-way; insulated; red	www.wago.com/2002-410/000-005
	Item no.: 2002-410/000-006 Jumper; 10-way; insulated; blue	www.wago.com/2002-410/000-006
	Item no.: 2002-410 Jumper; 10-way; insulated; light gray	www.wago.com/2002-410
	Item no.: 2002-409/000-006 Jumper; 9-way; insulated; blue	www.wago.com/2002-409/000-006
	Item no.: 2002-409/000-005 Jumper; 9-way; insulated; red	www.wago.com/2002-409/000-005
	Item no.: 2002-409 Jumper; 9-way; insulated; light gray	www.wago.com/2002-409
	Item no.: 2002-423/000-006 Continuous jumper; from 1 to 3; insulated; blue	www.wago.com/2002-423/000-006
	Item no.: 2002-423 Continuous jumper; from 1 to 3; insulated; light gray	www.wago.com/2002-423

Subject to changes. Please also observe the further product documentation!





	Item no.: 2002-433 Jumper; from 1 to 3; insulated; light gray	www.wago.com/2002-433
	Item no.: 2002-434 Jumper; from 1 to 4; insulated; light gray	www.wago.com/2002-434
	Item no.: 2002-423/000-005 Continuous jumper; from 1 to 3; insulated; red	www.wago.com/2002-423/000-005
	Item no.: 2002-435 Jumper; from 1 to 5; insulated; light gray	www.wago.com/2002-435
	Item no.: 2002-436 Jumper; from 1 to 6; insulated; light gray	www.wago.com/2002-436
	Item no.: 2002-437 Jumper; from 1 to 7; insulated; light gray	www.wago.com/2002-437
	Item no.: 2002-438 Jumper; from 1 to 8; insulated; light gray	www.wago.com/2002-438
	Item no.: 2002-439 Jumper; from 1 to 9; insulated; light gray	www.wago.com/2002-439
	Item no.: 2002-440 Jumper; from 1 to 10; insulated; light gray	www.wago.com/2002-440
	Item no.: 2002-472 Staggered jumper; 2-way; insulated; light gray	www.wago.com/2002-472
	Item no.: 2002-473 Staggered jumper; 3-way; insulated; light gray	www.wago.com/2002-473
	Item no.: 2002-475/011-000 Staggered jumper; 3-way; insulated; light gray	www.wago.com/2002-475/011-000
	Item no.: 2002-475 Staggered jumper; 5-way; insulated; light gray	www.wago.com/2002-475
	Item no.: 2002-476 Staggered jumper; 6-way; insulated; light gray	www.wago.com/2002-476
	Item no.: 2002-474 Staggered jumper; 4-way; insulated; light gray	www.wago.com/2002-474
	Item no.: 2002-477 Staggered jumper; 7-way; insulated; light gray	www.wago.com/2002-477
	Item no.: 2002-473/011-000 Staggered jumper; 2-way; from 1 to 3; insulated; light gray	www.wago.com/2002-473/011-000

Subject to changes. Please also observe the further product documentation!

	Item no.: 2002-479 Staggered jumper; 9-way; insulated; light gray	www.wago.com/2002-479
	Item no.: 2002-478 Staggered jumper; 8-way; insulated; light gray	www.wago.com/2002-478
	Item no.: 2002-479/011-000 Staggered jumper; insulated; light gray	www.wago.com/2002-479/011-000
	Item no.: 2002-480 Staggered jumper; 10-way; insulated; light gray	www.wago.com/2002-480
	Item no.: 2002-477/011-000 Staggered jumper; insulated; light gray	www.wago.com/2002-477/011-000
	Item no.: 2002-481/011-000 Staggered jumper; insulated; light gray	www.wago.com/2002-481/011-000
	Item no.: 2002-481 Staggered jumper; 11-way; insulated; light gray	www.wago.com/2002-481
	Item no.: 2002-482 Staggered jumper; 12-way; insulated; light gray	www.wago.com/2002-482

Carrier rail

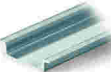
Mounting accessories

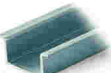
	Item no.: 210-197 Steel carrier rail; 35 x 15 mm; 1.5 mm thick; 2 m long; slotted; similar to EN 60715; silver-colored	www.wago.com/210-197
	Item no.: 210-198 Copper carrier rail; 35 x 15 mm; 2.3 mm thick; 2 m long; unslotted; according to EN 60715; copper-colored	www.wago.com/210-198
	Item no.: 210-113 Steel carrier rail; 35 x 7.5 mm; 1 mm thick; 2 m long; unslotted; according to EN 60715; silver-colored	www.wago.com/210-113
	Item no.: 210-118 Steel carrier rail; 35 x 15 mm; 2.3 mm thick; 2 m long; unslotted; according to EN 60715; silver-colored	www.wago.com/210-118
	Item no.: 210-112 Steel carrier rail; 35 x 7.5 mm; 1 mm thick; 2 m long; slotted; according to EN 60715; "Hole width 25 mm; silver-colored	www.wago.com/210-112
	Item no.: 210-114 Steel carrier rail; 35 x 15 mm; 1.5 mm thick; 2 m long; unslotted; similar to EN 60715; silver-colored	www.wago.com/210-114
	Item no.: 210-115	

Subject to changes. Please also observe the further product documentation!



Steel carrier rail; 35 x 7.5 mm; 1 mm thick; 2 m long; slotted; according to EN 60715; "Hole width 18 mm; www.wago.com/210-115 silver-colored



Item no.: 210-196
Aluminum carrier rail; 35 x 8.2 mm; 1.6 mm thick; 2 m long; unslotted; similar to EN 60715; silver-colored www.wago.com/210-196

Coding

Coding



Item no.: 2022-100
Carrier with 6 coding pins; for coding of female plugs; orange www.wago.com/2022-100

Push-in type wire jumper

Jumper



Item no.: 2009-412
Push-in type wire jumper; insulated; 60 mm long; black www.wago.com/2009-412



Item no.: 2009-414
Push-in type wire jumper; 1.5 mm²; insulated; 110 mm long; black www.wago.com/2009-414



Item no.: 2009-416
Push-in type wire jumper; 1.5 mm²; insulated; 250 mm long; black www.wago.com/2009-416



Item no.: 2009-414/000-005
Push-in type wire jumper; 1.5 mm²; insulated; 110 mm long; black www.wago.com/2009-414/000-005



Item no.: 2009-414/000-006
Push-in type wire jumper; insulated; 110 mm long; black www.wago.com/2009-414/000-006

Tool

Operating tool



Item no.: 210-720
Operating tool; Blade: 3.5 x 0.5 mm; with a partially insulated shaft; multicoloured www.wago.com/210-720

Downloads

Documentation

Bid Text

2022-1602 X81 - Datei	2019. 5. 20.	xml 4.4 kB	Download
2022-1602 docx - Datei	2019. 5. 20.	docx 15.6 kB	Download

Additional Information

Subject to changes. Please also observe the further product documentation!

WAGO GmbH & Co. KG
Hansastr. 27
32423 Minden
Phone: +49571 887-0 | Fax: +49571 887-169
Email: info.de@wago.com | Web: www.wago.com

Do you have any questions about our products?
We are always happy to take your call at +49 (571) 887-44222.

Technical Section

Technical explanations

pdf
2.2 MB

[Download](#)

CAD/CAE-Data

CAD data

2D/3D Models 2022-1602

[URL](#)

[Download](#)

CAE data

ZUKEN Portal 2022-1602

[URL](#)

[Download](#)

Environmental Product Compliance

Compliance Search

Environmental Product Compliance 2022-1602

[URL](#)

[Download](#)

2-pin carrier terminal block; for DIN-rail 35 x 15 and 35 x 7.5; orange

Installation Notes

Installation

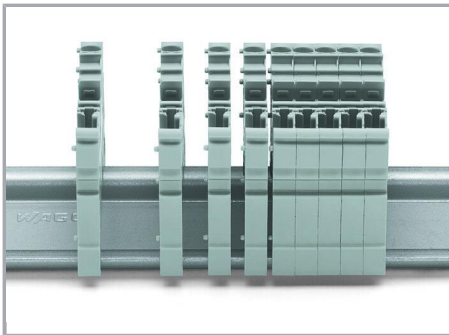

Snap individual carrier terminal blocks onto the DIN-rail and slide together.

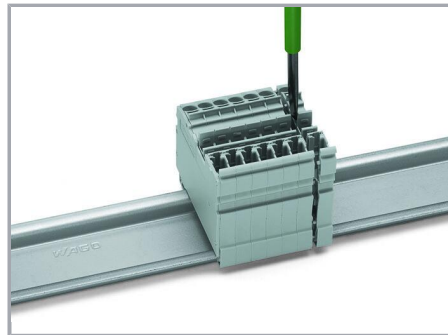

Open the assembly by laterally sliding a block via operating tool (3.5 x 0.5 mm blade).

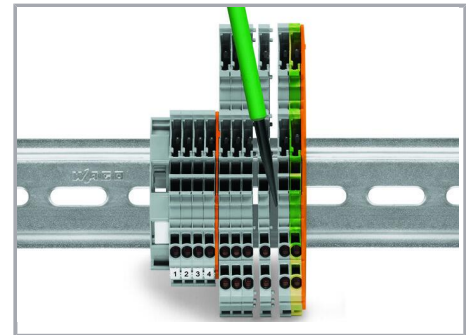

Separate terminal block assembly and slide individual terminal blocks laterally using an operating tool.

Commoning

Subject to changes. Please also observe the further product documentation!

WAGO GmbH & Co. KG

Hansastr. 27

32423 Minden

Phone: +49571 887-0 | Fax: +49571 887-169

Email: info.de@wago.com | Web: www.wago.com

Do you have any questions about our products?

We are always happy to take your call at +49 (571) 887-44222.

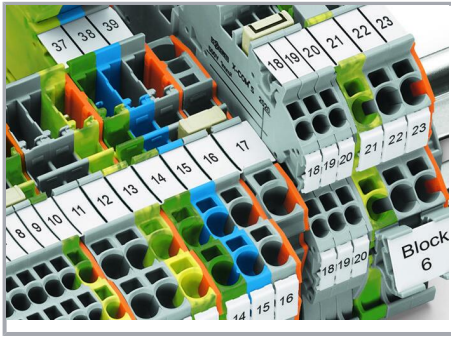

Commoning X-COM®S-SYSTEM Terminal Blocks using jumpers for TOPJOB® S Terminal Blocks. An end plate provides connection to TOPJOB® S Terminal Blocks. 2020 and 2022 Series Terminal Blocks are combinable. Jumper slots are on the same level for both series.

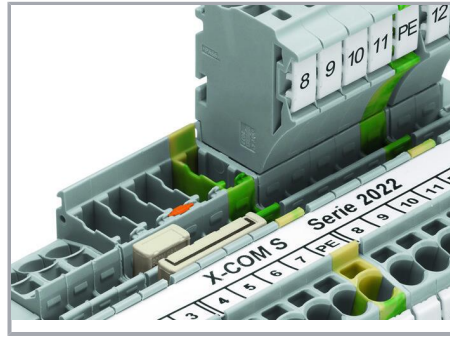

Pairing push-in comb style jumpers.

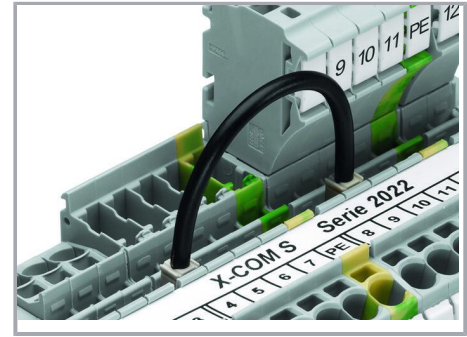

Commoning with push-in type wire jumper.

Testing

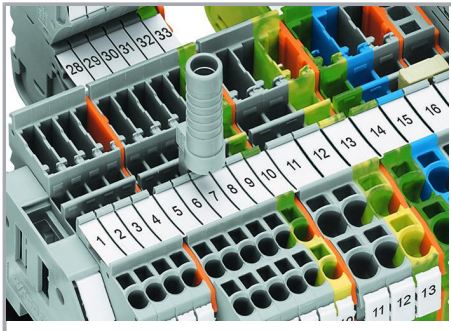

Test plug adapter (2009-174) for 4 mm test plugs or banana plugs – also suitable for X-COM®S-SYSTEM-MINI Terminal Blocks.

Coding

Subject to changes. Please also observe the further product documentation!

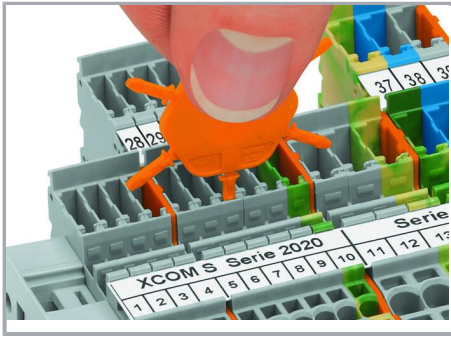

Insert coding pin into the corresponding slot and twist it off.



Coding a female plug: remove coding finger using a suitable tool.

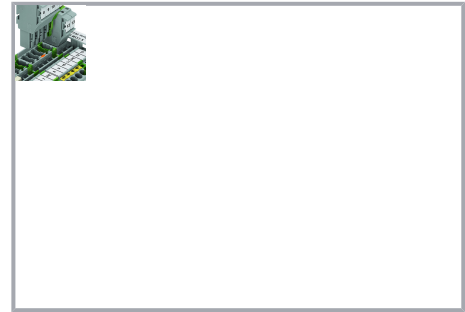

Insert a coding pin (2022-100) into the corresponding location of the carrier terminal block.



Marking

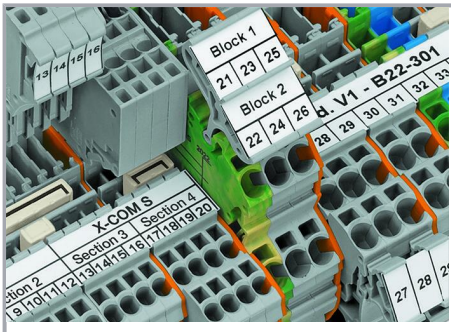

Clear marking via large marking area

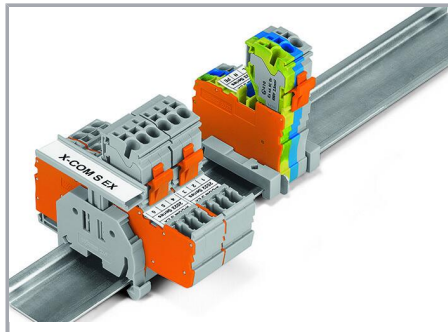

Group marking with height-adjustable group marker carrier (2009-163)

Safety

Subject to changes. Please also observe the further product documentation!



Carrier terminal blocks and female plugs are touch-proof.

Product family

X-COM S

[Show all products from the family](#)

Subject to changes. Please also observe the further product documentation!