

**MMBT3906 TRANSISTOR (PNP)**
**FEATURES**

- Complementary Type The NPN Transistor
- MMBT3904 is Recommended
- Epitaxial Planar Die Construction

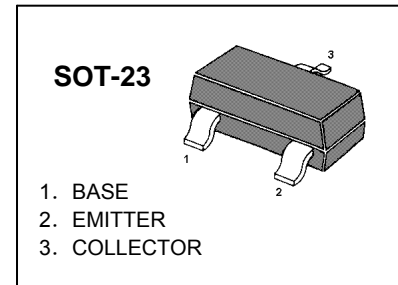

**MARKING: 2A**
**MAXIMUM RATINGS (T<sub>a</sub>=25°C unless otherwise noted)**

Symbol	Parameter	Value	Unit
V <sub>CBO</sub>	Collector-Base Voltage	-40	V
V <sub>CEO</sub>	Collector-Emitter Voltage	-40	V
V <sub>EBO</sub>	Emitter-Base Voltage	-5	V
I <sub>C</sub>	Collector Current	-200	mA
P <sub>C</sub>	Total Device Dissipation	200	mW
R <sub>θJA</sub>	Thermal Resistance Junction to Ambient	625	°C/W
T <sub>J</sub>	Junction Temperature	150	°C
T <sub>stg</sub>	Storage Temperature	-55 ~ +150	°C

**ELECTRICAL CHARACTERISTICS (T<sub>a</sub>=25°C unless otherwise specified)**

Parameter	Symbol	Test conditions	Min	Max	Unit
Collector-base breakdown voltage	V <sub>(BR)CBO</sub>	I <sub>C</sub> =-10μA, I <sub>E</sub> =0	-40		V
Collector-emitter breakdown voltage	V <sub>(BR)CEO</sub>	I <sub>C</sub> =-1mA, I <sub>B</sub> =0	-40		V
Emitter-base breakdown voltage	V <sub>(BR)EBO</sub>	I <sub>E</sub> =-10μA, I <sub>C</sub> =0	-5		V
Collector cut-off current	I <sub>CBO</sub>	V <sub>CB</sub> =-40V, I <sub>E</sub> =0		-0.1	μA
Collector cut-off current	I <sub>CEX</sub>	V <sub>CE</sub> =-30V, V <sub>BE(off)</sub> =-3V		-50	nA
Emitter cut-off current	I <sub>EBO</sub>	V <sub>EB</sub> =-5V, I <sub>C</sub> =0		-0.1	μA
DC current gain	h <sub>FE(1)</sub>	V <sub>CE</sub> =-1V, I <sub>C</sub> =-10mA	100	300	
	h <sub>FE(2)</sub>	V <sub>CE</sub> =-1V, I <sub>C</sub> =-50mA	60		
	h <sub>FE(3)</sub>	V <sub>CE</sub> =-1V, I <sub>C</sub> =-100mA	30		
Collector-emitter saturation voltage	V <sub>CE(sat)</sub>	I <sub>C</sub> =-50mA, I <sub>B</sub> =-5mA		-0.3	V
Base-emitter saturation voltage	V <sub>BE(sat)</sub>	I <sub>C</sub> =-50mA, I <sub>B</sub> =-5mA		-0.95	V
Transition frequency	f <sub>T</sub>	V <sub>CE</sub> =-20V, I <sub>C</sub> =-10mA, f=100MHz	300		MHz
Delay Time	t <sub>d</sub>	V <sub>CC</sub> =-3V, V <sub>BE</sub> =-0.5V		35	nS
Rise Time	t <sub>r</sub>	I <sub>C</sub> =-10mA, I <sub>B1</sub> =-I <sub>B2</sub> =-1mA		35	nS
Storage Time	t <sub>s</sub>	V <sub>CC</sub> =-3V, I <sub>C</sub> =-10mA,		225	nS
Fall Time	t <sub>f</sub>	I <sub>B1</sub> =-I <sub>B2</sub> =-1mA		75	nS

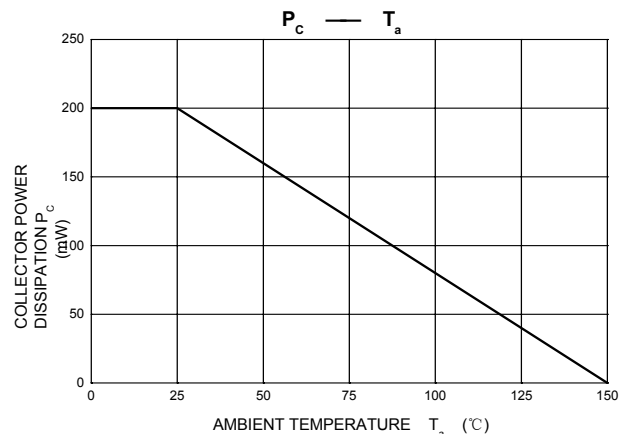
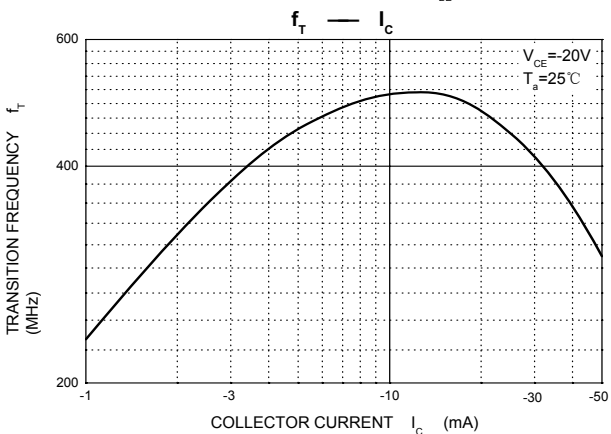
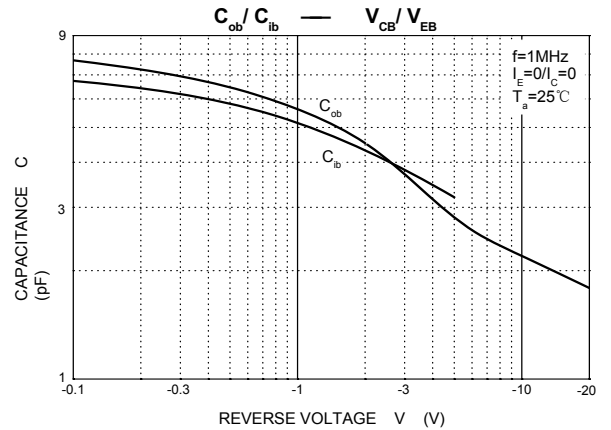
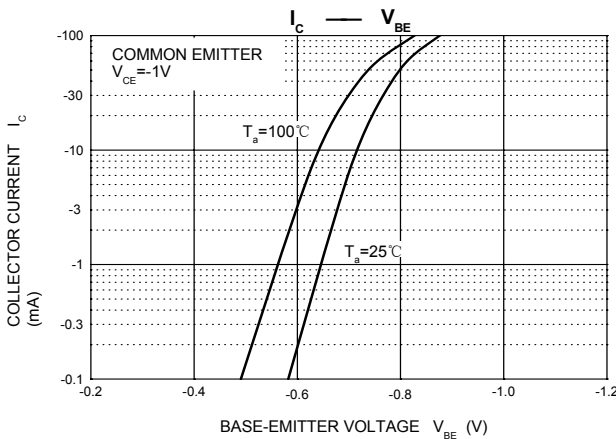
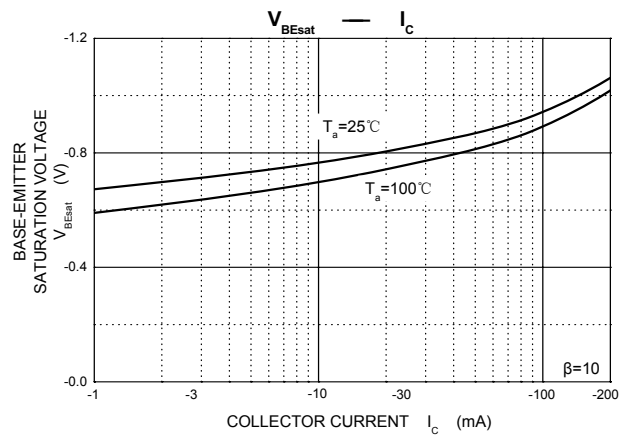
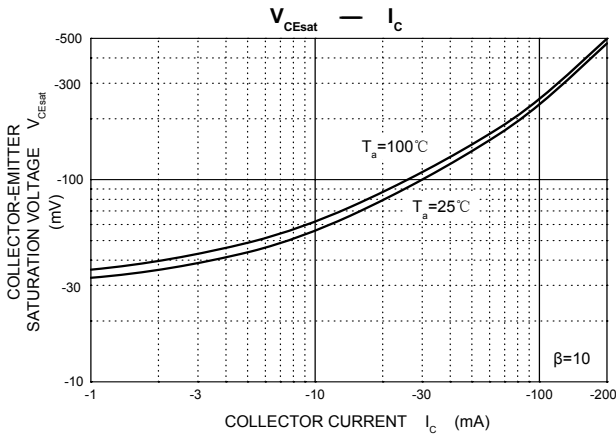
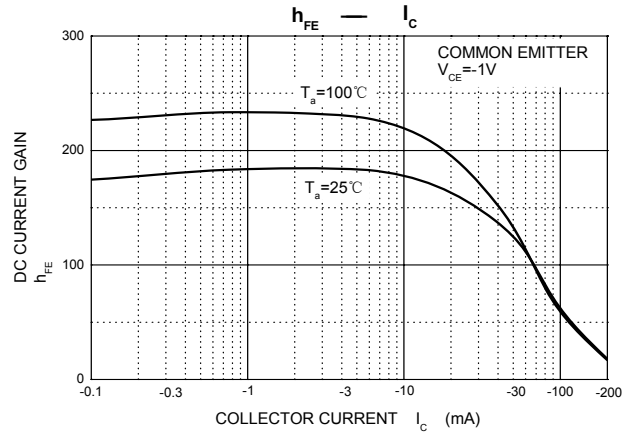
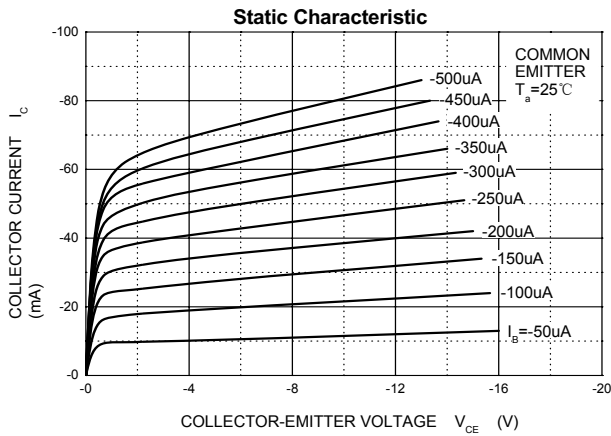
Typical Characteristics



PACKAGE OUTLINE

Plastic surface mounted package; 3 leads

SOT-23

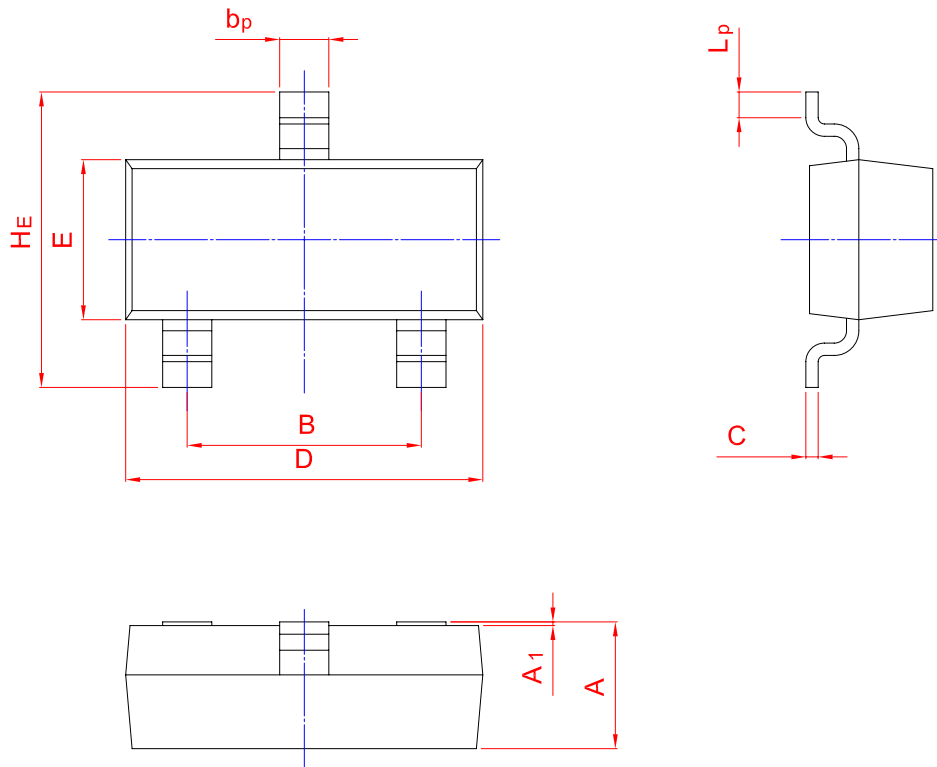

UNIT	A	B	$b_p$	C	D	E	$H_E$	$A_1$	$L_p$
mm	1.40	2.04	0.50	0.19	3.10	1.65	3.00	0.100	0.50
	0.95	1.78	0.35	0.08	2.70	1.20	2.20	0.013	0.20