



**江苏长晶科技股份有限公司**  
JIANGSU CHANGJING ELECTRONICS TECHNOLOGY CO., LTD.

## 产 品 规 格 书

### SPECIFICATIONS FOR PRODUCT

产品类型 TYPE : SMD3225

产品规格 SPEC : 32.768MHz/3225/10PF/10PPM AEC-Q200

产品型号 P/N : AD-CJ13-327681010C30

日期 DATE : 2022/04/02

<b>核准及签名</b>			<b>部门</b>
R&D APPR. SIGNATURED			DEPT.
<b>拟制</b>	<b>审核</b>	<b>批准</b>	频率器件事业部
ISSUE	CHECK	APPROVAL	
Ivan 2022/04/02	Abbey 2022/04/02	Ken 2022/04/02	

江 苏 长 晶 科 技 股 份 有 限 公 司

JIANGSU CHANGJING ELECTRONICS TECHNOLOGY CO., LTD.

地址：中国江苏省南京江北新区产业技术研创园江淼路88号腾飞大厦C座13楼

Add: 13Th Floor, C Block, Tengfei Building, No. 88 Jiangmiao Rd. Pukou

District, Nanjing City, Jiangsu Province, China



**SMCE3225 4 pads Crystal Resonator**

**AD-CJ13-327681010C30**

1. Scope:

- 1.1 This specification applies to the RoHS/SONY compliance quartz crystal unit with a frequency of 32.768MHz which will be used in crystal oscillator applications.
- 1.2 AEC-Q200 qualified

2. Construction:

- 2.1 Type of Quartz Resonator: SMCE3225 4pads

3. Electrical Characteristics

- 3.1 Nominal Frequency(f): 32.768MHz
- 3.2 Load Capacitance( $C_L$ ): 10pF
- 3.3 Frequency Tolerance( $\Delta f/f$ ):  $\pm 10$ ppm
- 3.4 Frequency Temperature Stability:  $\pm 30$ ppm(Ref. @25°C)
- 3.5 Resonance Resistance(ohm): 40ohms Max
- 3.6 Osc mode: Fundamental mode
- 3.7 Shunt Capacitance( $C_0$ ): <2pF
- 3.8 Drive Level( $D_L$ ): <100 $\mu$ W
- 3.9 Operating Temperature Range( $T_{OPR}$ ): -40 to + 105
- 3.10 Storage Temperature Range( $T_{STG}$ ): -55 to + 125°C
- 3.11 Insulation Resistance(IR): >500 M ohms
- 3.12 Aging( $\Delta f_A$ ):  $\pm 3$ ppm per Year

## 4. Reliability Specifications

This is the quality control and quality assurance and reliability tests performance data for the RoHS/

AEC-Q200 compliance 32.768MHz SMCE3225 4pads crystal resonators

related to the specification and approval sheet provided by JSCJ .

Standard test condition (TEMP.: 20±5°C. Relative humidity: 65±20%)

For any discrepancy in GO/NG, test will be done at TEMP.25±2°C, R.H. 65±5%.

NO.	PROCESS	SPECIFICATION	TEST METHOD
4.1	Temperature Cycle	Frequency change after test $\pm 5$ ppm.Resonance resistance change after test $\leq 5$ ohms.	1000 cycles from -40°C to 125°C. Measurement taken after DUT being left at room temperature for 24±2 hours.
4.2	High Temperature Storage	Frequency change after test $\pm 5$ ppm.Resonance resistance change after test $\leq 5$ ohms.	Spending 1000 hrs at 85°C±3°C constant temperature. Measurement taken after DUT being left at room temperature for 24±2 hours.
4.3	Biased Humidity	Frequency change after test $\pm 5$ ppm.Resonance resistance change after test $\leq 5$ ohms.	Spending 1000 hrs at 85 °C ± 3 °C, with 85%R.H, Then keep the DUT in dry oven at 25 ± 5 °C for 24 hour. Measurement taken after DUT being left at room temperature for 1 to 2 hours.
4.4	Operational Life	Frequency change after test $\pm 5$ ppm.Resonance resistance change after test $\leq 5$ ohms.	Spending 1000 hrs at 125°C±3°C constant temperature. Measurement taken after DUT being left at room temperature for 24±2 hours.
4.5	Vibration	Frequency change after test $\pm 5$ ppm.Resonance resistance change after test $\leq 5$ ohms.	Apply 1.52mm vibration at sweep frequency 10~2000Hz, 5g's for 20min 12 cycles in each direction of 3 axis. Measurement taken after 1 hour.
4.6	Mechanical Shock	Frequency change after test $\pm 5$ ppm.Resonance resistance change after test $\leq 5$ ohms.and exhibit no visible damage.	Peak 100gal, normal width 6ms half sine wave form, 3.7m/s, 3 cycles / direction. Measurement taken after 1 hour.
4.7	Solderability	Terminals shall be covered more then 95% with solder.	Passed through the re-flow oven under the following condition. Preheat 150 to 180°C for 60 to 120sec, and soldering time for 20s ± 5s at 235°C, peak soldering time for 5s ±0.5s between 240 and 250°C. There is no need to do functional test. 8-12X magnifier.
4.8	Terminal Strength	No visible damage	Mount on a glass-epoxy board (100x50x1.6mm), then bend to 2mm displacement (velocity 1mm/sec) and keep for 5 seconds. or pulling force 1.8kg for at least 60 seconds.
4.9	Resistance to Soldering Heat	Frequency change after test $\pm 5$ ppm.Resonance resistance change after test $\leq 5$ ohms.	Passed through the re-flow oven under the following condition. Preheat 150 to 180°C for 60 to 120sec, and sodering time for 60s max at 235°C, peak soldering time for 10s max at 265°C max. Measurement taken after DUT being left at room temperature for at least 2 hours.
4.10	OTHERS		

5. Recommended Reflow soldering condition (SMD)

Solder profile

Peak:  $260 \pm 5^\circ\text{C}$  Soldering zone:  $230^\circ\text{C}$  or more,  $30 \pm 10\text{s}$ . Pre-heating zone 1:  $150 \sim 180^\circ\text{C}$ ,  $90 \pm 30\text{s}$

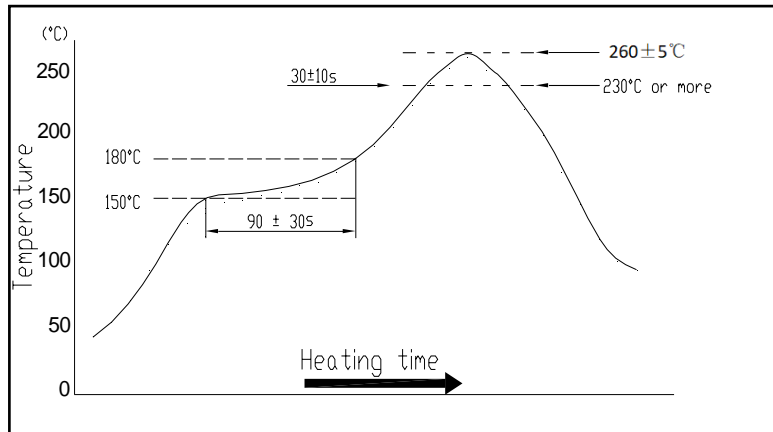

Temperature profile for reflow soldering

6. Soldering iron method

Bit temperature:  $350 \pm 10^\circ\text{C}$  Application time of soldering iron:  $3+1\text{ s}$ . For other procedures, refer to IEC 60068-2-20.

## Package Outline Dimensions

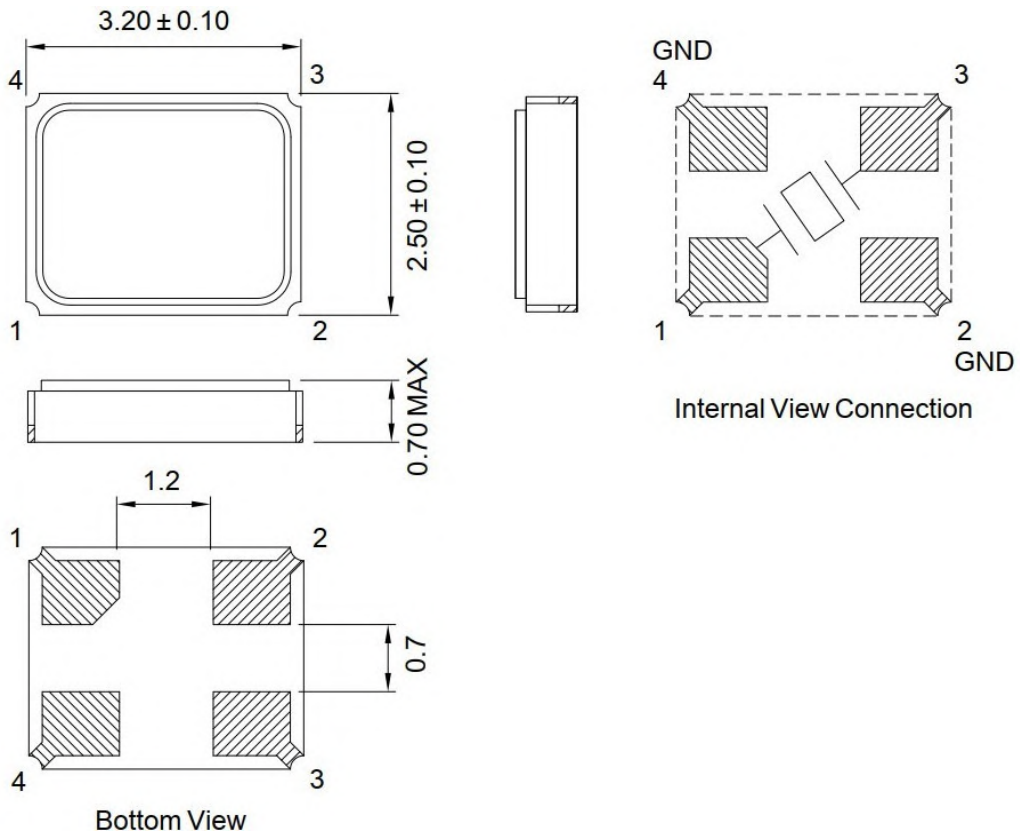

## Suggested Pad Layout

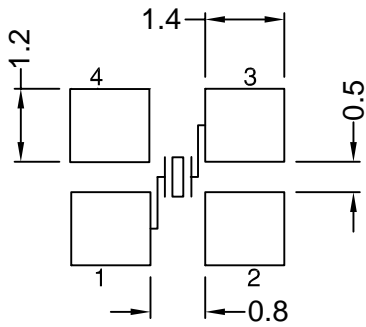

---

## Marking

---

### Procedure: Laser

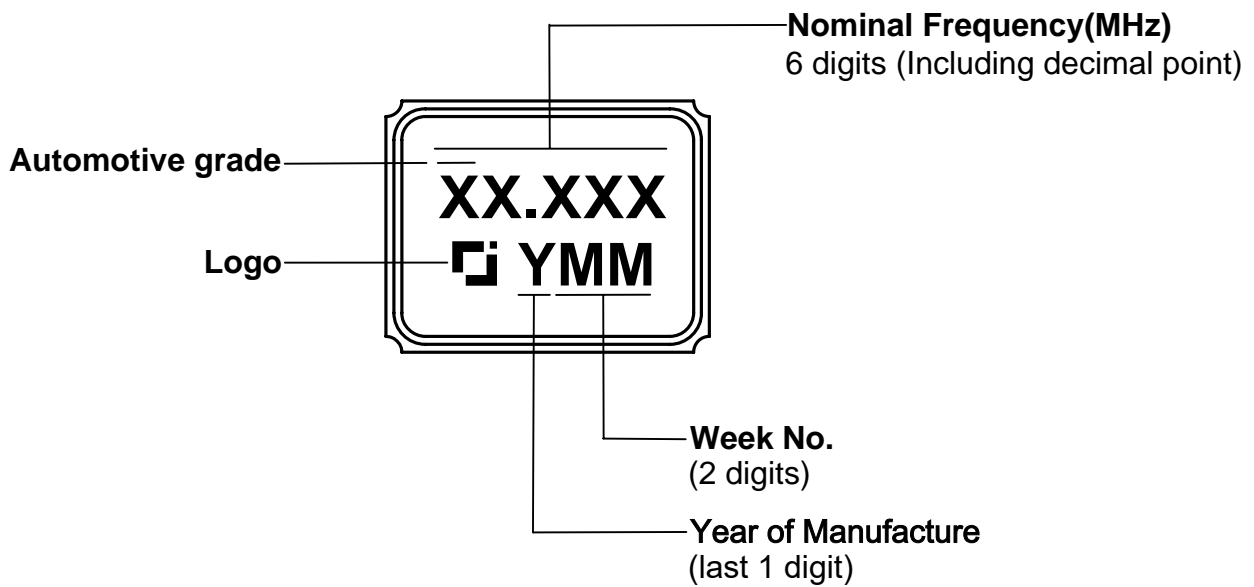

For example:

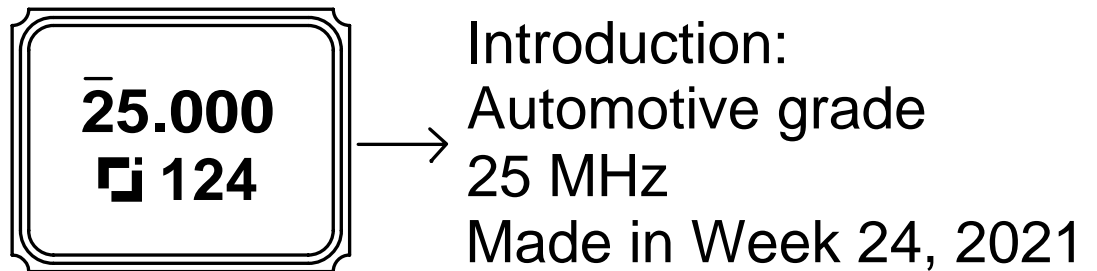

---

## Inside Structure

---

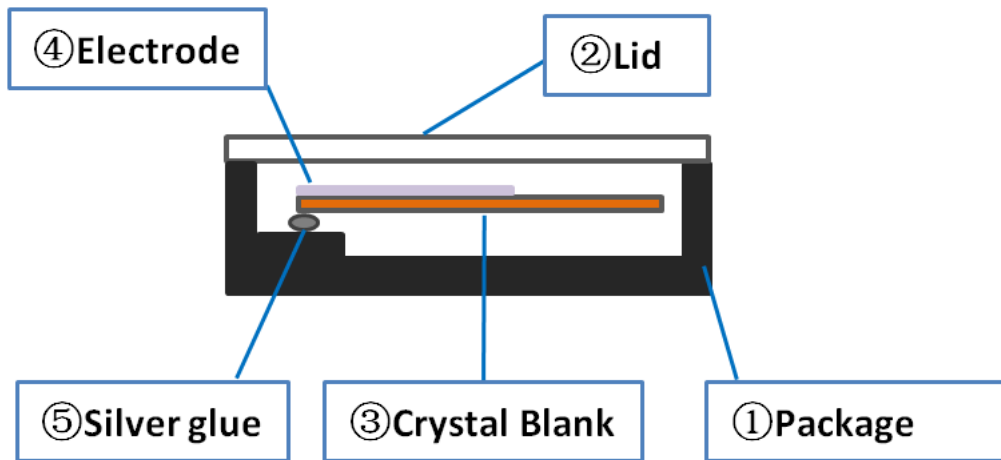

No.	Components	Materials
1	Package	Ceramic( $\text{Al}_2\text{O}_3$ )
2	Lid	KV(Fe/Ni/Co)
3	Crystal blank	$\text{SiO}_2$
4	Electrode	Ag, Cr
5	Silver glue	Ag, $\text{CH}_3\text{OH}$ , $\text{SiO}_2$

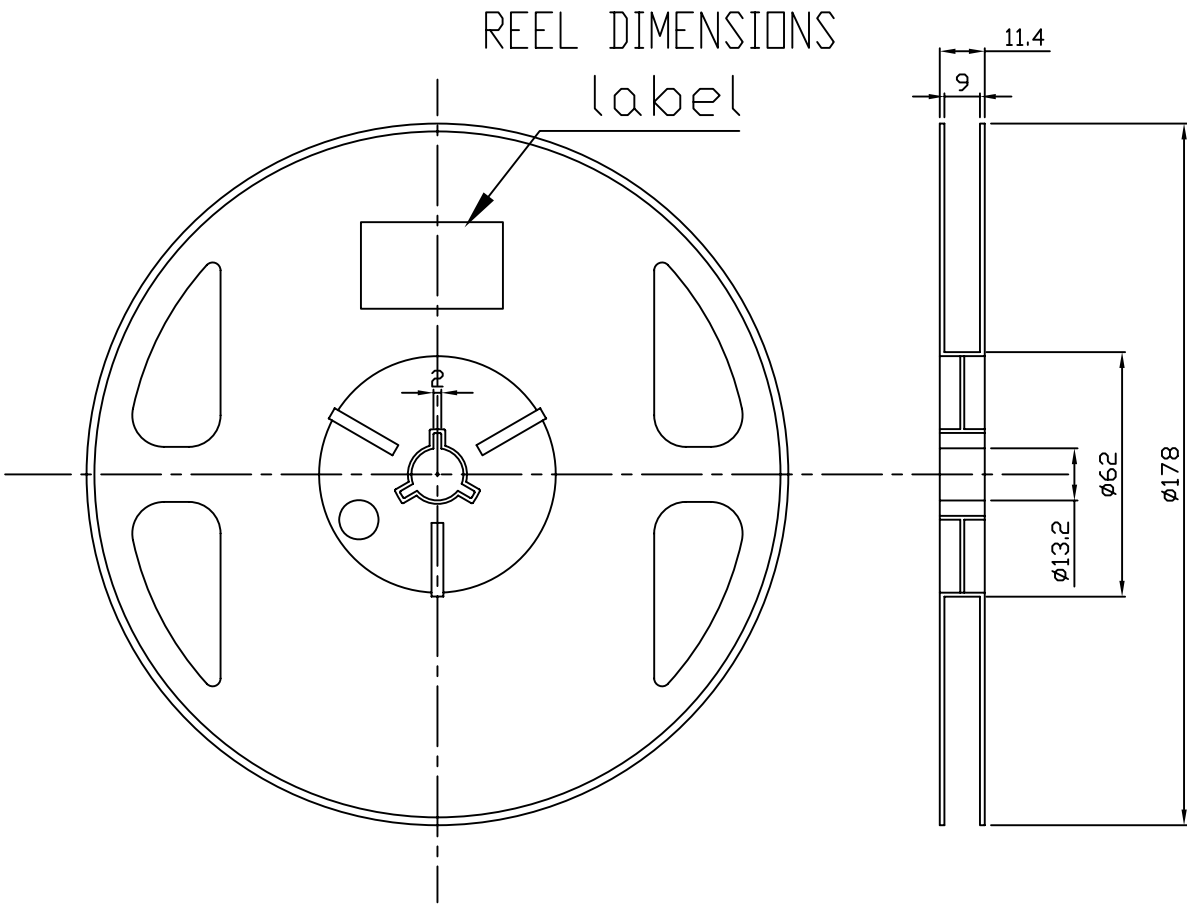

EMBOSSED TYPE DIMENSIONS

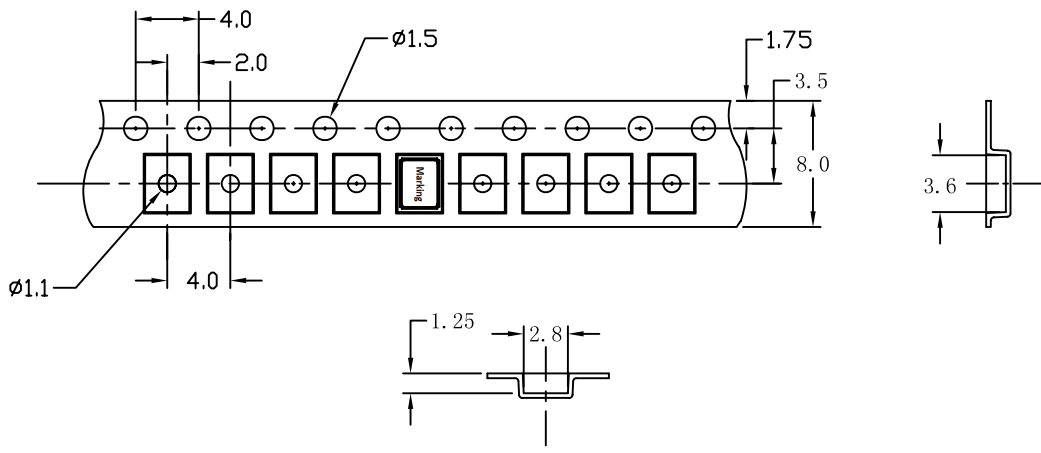

USER FEED DIRECTION

→



# Package

## Inside package

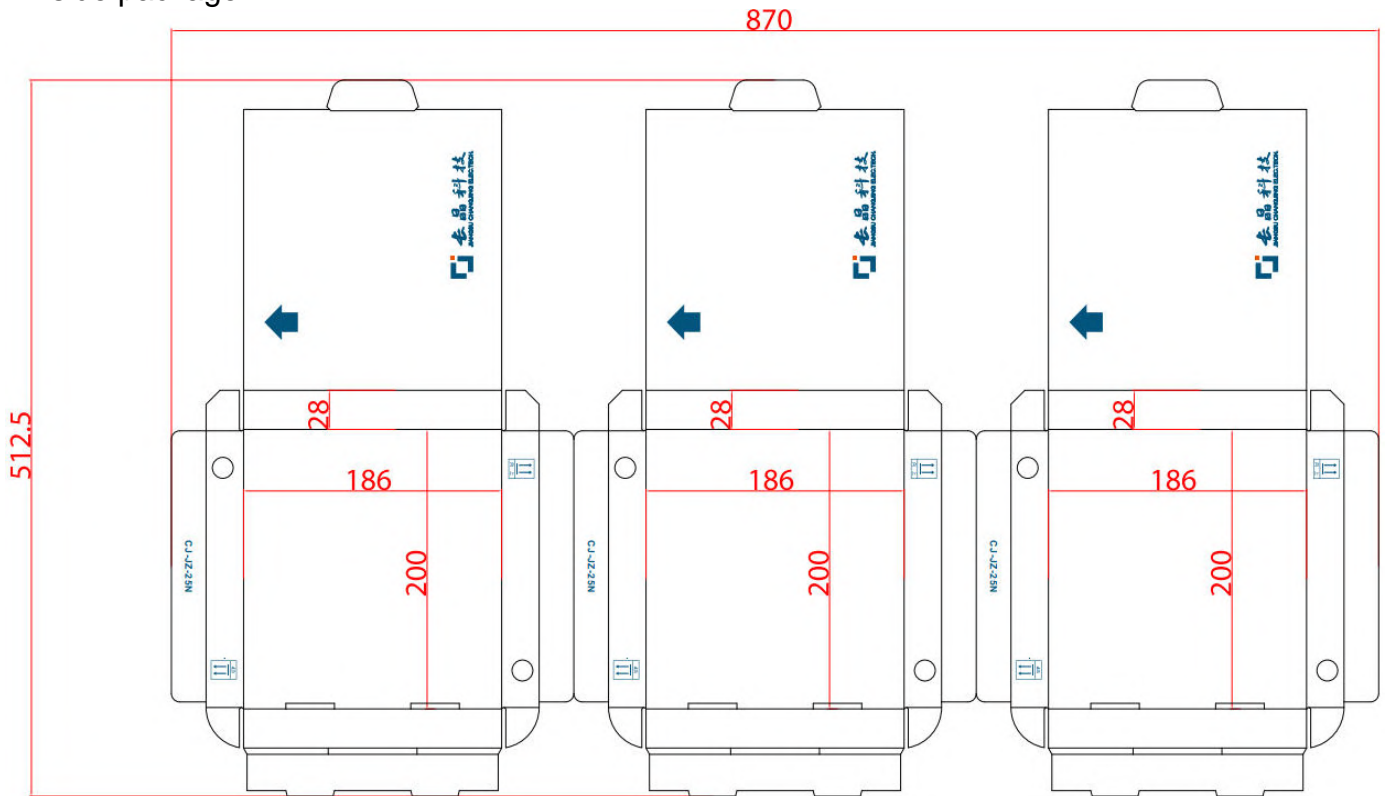

## Outside package

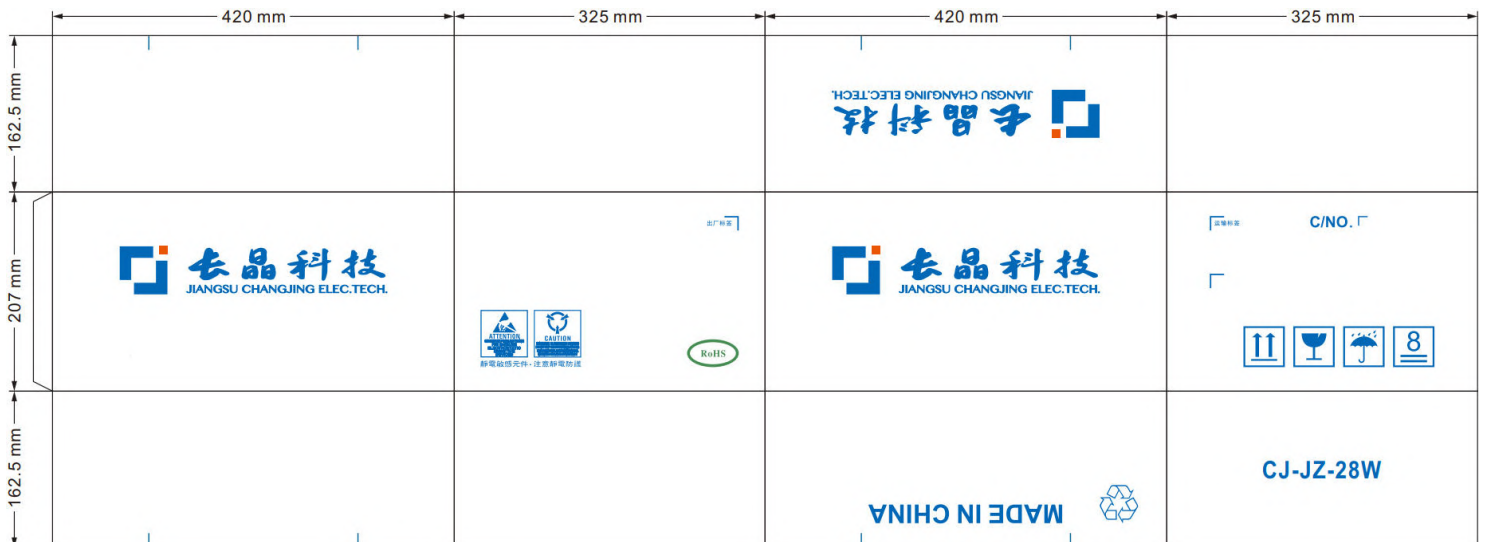

### NOTICE

JSCJ reserve the right to make modifications,enhancements, improvements, corrections or other changes without further notice to any product herein.JSCJ does not assume any liability arising out of the application or use of any product described herein.