



March 2016

FGH40T70SHD 700 V, 40 A Field Stop Trench IGBT

Features

- Maximum Junction Temperature : $T_J = 175^\circ\text{C}$
- Positive Temperature Co-efficient for Easy Parallel Operating
- High Current Capability
- Low Saturation Voltage: $V_{CE(sat)} = 1.7\text{ V(Typ.) @ } I_C = 40\text{ A}$
- 100% of the Parts Tested for $I_{LM}(1)$
- High Input Impedance
- Fast Switching
- Tighten Parameter Distribution
- RoHS Compliant

General Description

Using novel field stop IGBT technology, Fairchild's new series of field stop 3rd generation IGBTs offer the optimum performance for solar inverter, UPS, welder, telecom, ESS and PFC applications where low conduction and switching losses are essential.

Applications

- Solar Inverter, UPS, Welder, Telecom, ESS, PFC

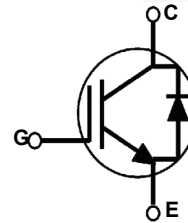
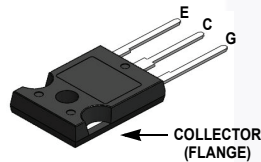

Absolute Maximum Ratings $T_C = 25^\circ\text{C}$ unless otherwise noted

Symbol	Description	FGH40T70SHD_F155	Unit
V_{CES}	Collector to Emitter Voltage	700	V
V_{GES}	Gate to Emitter Voltage	± 20	V
	Transient Gate to Emitter Voltage	± 30	V
I_C	Collector Current @ $T_C = 25^\circ\text{C}$	80	A
	Collector Current @ $T_C = 100^\circ\text{C}$	40	A
$I_{LM}(1)$	Pulsed Collector Current @ $T_C = 25^\circ\text{C}$	120	A
$I_{CM}(2)$	Pulsed Collector Current	120	A
I_F	Diode Forward Current @ $T_C = 25^\circ\text{C}$	40	A
	Diode Forward Current @ $T_C = 100^\circ\text{C}$	20	A
$I_{FM}(2)$	Pulsed Diode Maximum Forward Current	120	A
P_D	Maximum Power Dissipation @ $T_C = 25^\circ\text{C}$	268	W
	Maximum Power Dissipation @ $T_C = 100^\circ\text{C}$	134	W
T_J	Operating Junction Temperature	-55 to +175	$^\circ\text{C}$
T_{stg}	Storage Temperature Range	-55 to +175	$^\circ\text{C}$
T_L	Maximum Lead Temp. for soldering Purposes, 1/8" from case for 5 seconds	300	$^\circ\text{C}$

Notes:

1. $V_{CC} = 400\text{ V}$, $V_{GE} = 15\text{ V}$, $I_C = 120\text{ A}$, $R_G = 30\ \Omega$, Inductive Load
2. Repetitive rating: Pulse width limited by max. junction temperature

FGH40T70SHD 700 V, 40 A Field Stop Trench IGBT

Thermal Characteristics

Symbol	Parameter	FGH40T70SHD_F155	Unit
$R_{\theta JC}$ (IGBT)	Thermal Resistance, Junction to Case, Max.	0.56	$^{\circ}\text{C}/\text{W}$
$R_{\theta JC}$ (Diode)	Thermal Resistance, Junction to Case, Max.	1.71	$^{\circ}\text{C}/\text{W}$
$R_{\theta JA}$	Thermal Resistance, Junction to Ambient, Max.	40	$^{\circ}\text{C}/\text{W}$

Package Marking and Ordering Information

Part Number	Top Mark	Package	Packing Method	Reel Size	Tape Width	Quantity
FGH40T70SHD_F155	FGH40T70SHD	TO-247 G03	Tube	N/A	N/A	30

Electrical Characteristics of the IGBT $T_C = 25^{\circ}\text{C}$ unless otherwise noted

Symbol	Parameter	Test Conditions	Min.	Typ.	Max.	Unit
Off Characteristics						
BV_{CES}	Collector to Emitter Breakdown Voltage	$V_{GE} = 0\text{V}, I_C = 1\text{mA}$	700	-	-	V
$\Delta BV_{CES} / \Delta T_J$	Temperature Coefficient of Breakdown Voltage	$I_C = 1\text{mA}$, Reference to 25°C	-	0.6	-	$\text{V}/^{\circ}\text{C}$
I_{CES}	Collector Cut-Off Current	$V_{CE} = V_{CES}, V_{GE} = 0\text{V}$	-	-	250	μA
I_{GES}	G-E Leakage Current	$V_{GE} = V_{GES}, V_{CE} = 0\text{V}$	-	-	± 400	nA
On Characteristics						
$V_{GE(th)}$	G-E Threshold Voltage	$I_C = 40\text{mA}, V_{CE} = V_{GE}$	4.0	5.5	7.5	V
$V_{CE(sat)}$	Collector to Emitter Saturation Voltage	$I_C = 40\text{A}, V_{GE} = 15\text{V}$	-	1.7	2.15	V
		$I_C = 40\text{A}, V_{GE} = 15\text{V}, T_C = 175^{\circ}\text{C}$	-	2.37	-	V
Dynamic Characteristics						
C_{ies}	Input Capacitance	$V_{CE} = 30\text{V}, V_{GE} = 0\text{V}, f = 1\text{MHz}$	-	2028	-	pF
C_{oes}	Output Capacitance		-	75	-	pF
C_{res}	Reverse Transfer Capacitance		-	26	-	pF
Switching Characteristics						
$t_{d(on)}$	Turn-On Delay Time	$V_{CC} = 400\text{V}, I_C = 40\text{A}, R_G = 6\ \Omega, V_{GE} = 15\text{V},$ Inductive Load, $T_C = 25^{\circ}\text{C}$	-	22	-	ns
t_r	Rise Time		-	40	-	ns
$t_{d(off)}$	Turn-Off Delay Time		-	66	-	ns
t_f	Fall Time		-	10	-	ns
E_{on}	Turn-On Switching Loss		-	1150	-	μJ
E_{off}	Turn-Off Switching Loss		-	271	-	μJ
E_{ts}	Total Switching Loss		-	1421	-	μJ
$t_{d(on)}$	Turn-On Delay Time	$V_{CC} = 400\text{V}, I_C = 40\text{A}, R_G = 6\ \Omega, V_{GE} = 15\text{V},$ Inductive Load, $T_C = 175^{\circ}\text{C}$	-	20	-	ns
t_r	Rise Time		-	36	-	ns
$t_{d(off)}$	Turn-Off Delay Time		-	68	-	ns
t_f	Fall Time		-	13	-	ns
E_{on}	Turn-On Switching Loss		-	1760	-	μJ
E_{off}	Turn-Off Switching Loss		-	455	-	μJ
E_{ts}	Total Switching Loss		-	2215	-	μJ

Electrical Characteristics of the IGBT (Continued)

Symbol	Parameter	Test Conditions	Min.	Typ.	Max	Unit
Q_g	Total Gate Charge	$V_{CE} = 400\text{ V}, I_C = 40\text{ A},$ $V_{GE} = 15\text{ V}$	-	69	-	nC
Q_{ge}	Gate to Emitter Charge		-	13	-	nC
Q_{gc}	Gate to Collector Charge		-	26	-	nC

Electrical Characteristics of the Diode $T_C = 25^\circ\text{C}$ unless otherwise noted

Symbol	Parameter	Test Conditions	Min.	Typ.	Max	Unit	
V_{FM}	Diode Forward Voltage	$I_F = 20\text{ A}$	$T_C = 25^\circ\text{C}$	-	2.0	2.5	V
			$T_C = 175^\circ\text{C}$	-	1.73	-	
E_{rec}	Reverse Recovery Energy	$I_F = 20\text{ A}, dI_F/dt = 200\text{ A}/\mu\text{s}$	$T_C = 175^\circ\text{C}$	-	54	-	uJ
t_{rr}	Diode Reverse Recovery Time		$T_C = 25^\circ\text{C}$	-	37	-	ns
			$T_C = 175^\circ\text{C}$	-	235	-	
Q_{rr}	Diode Reverse Recovery Charge		$T_C = 25^\circ\text{C}$	-	65	-	nC
		$T_C = 175^\circ\text{C}$	-	944	-		

Typical Performance Characteristics

Figure 1. Typical Output Characteristics

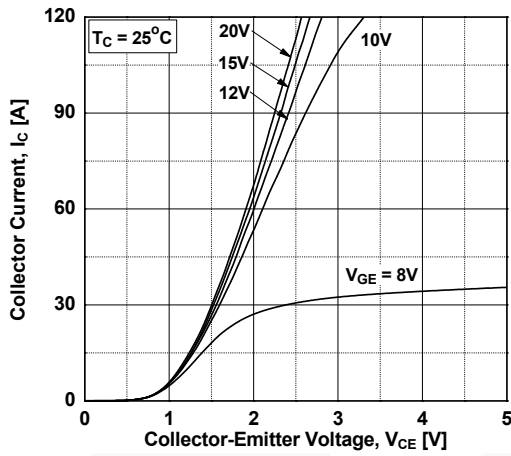

Figure 2. Typical Output Characteristics

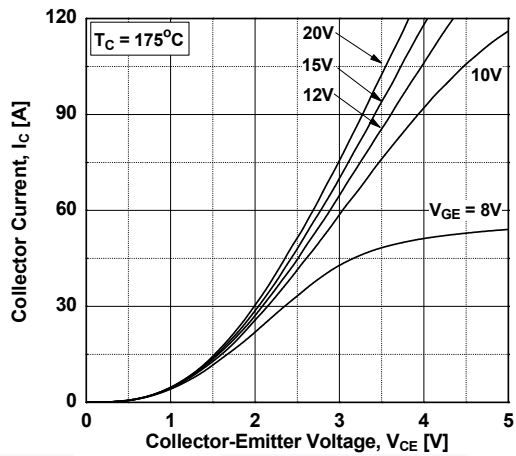

Figure 3. Typical Saturation Voltage Characteristics

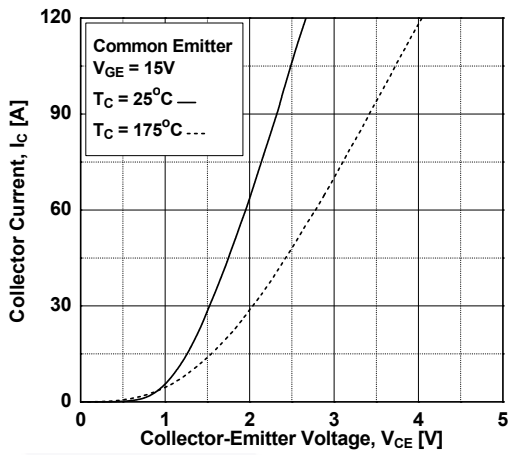

Figure 4. Saturation Voltage vs. Case Temperature at Variant Current Level

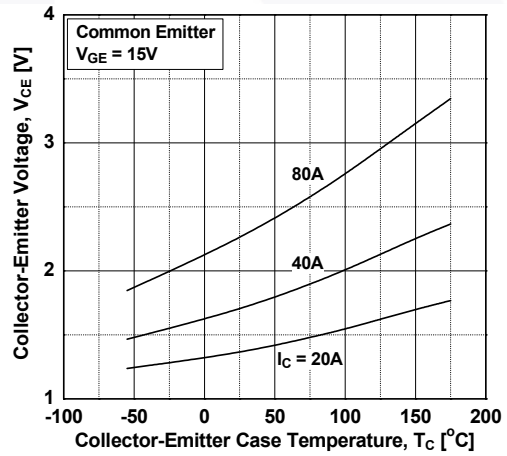

Figure 5. Saturation Voltage vs. Vge

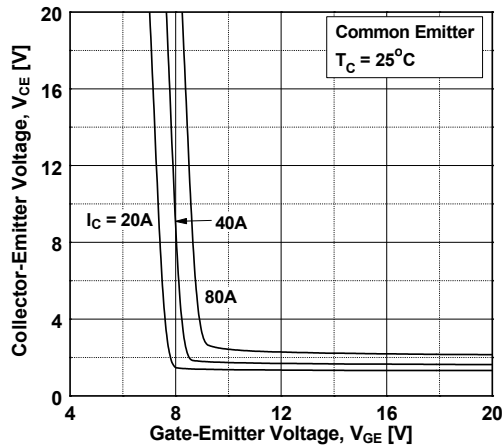
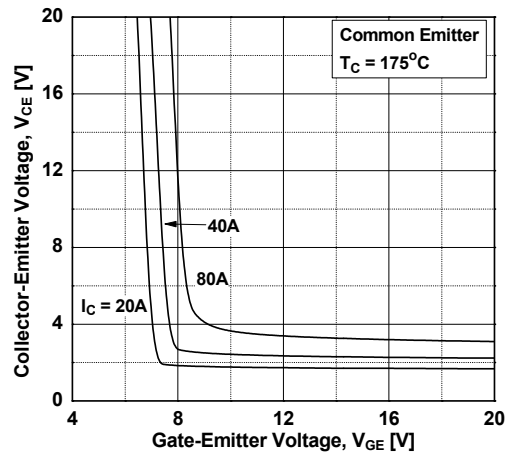

Figure 6. Saturation Voltage vs. Vge



Typical Performance Characteristics

Figure 7. Capacitance Characteristics

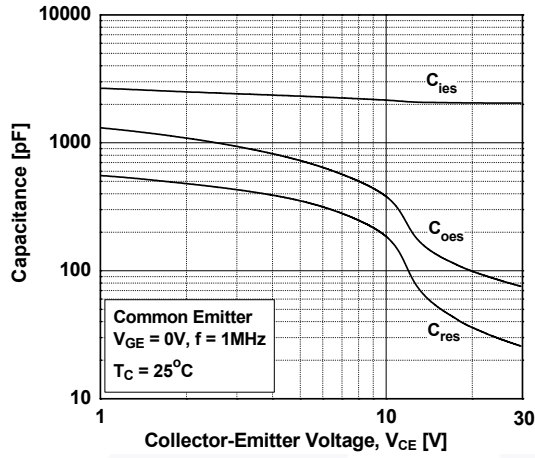

Figure 8. Gate charge Characteristics

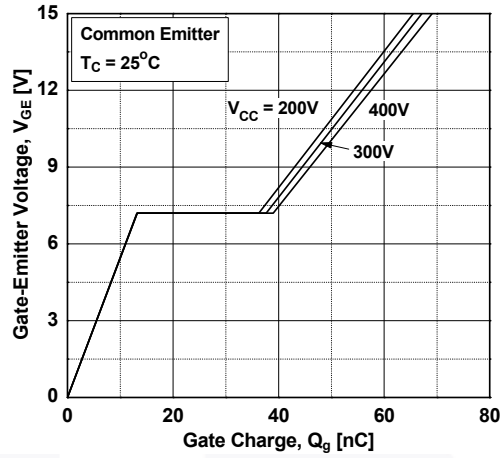

Figure 9. Turn-on Characteristics vs. Gate Resistance

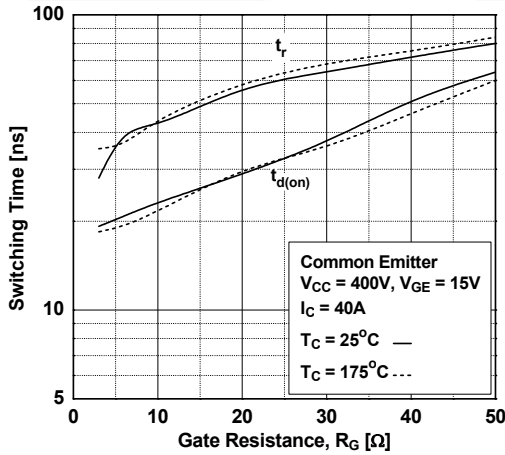

Figure 10. Turn-off Characteristics vs. Gate Resistance

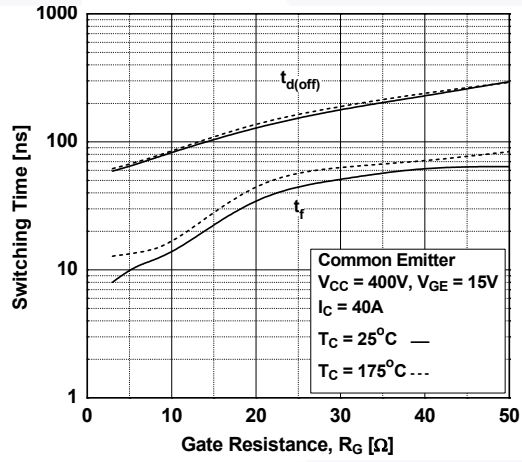

Figure 11. Switching Loss vs. Gate Resistance

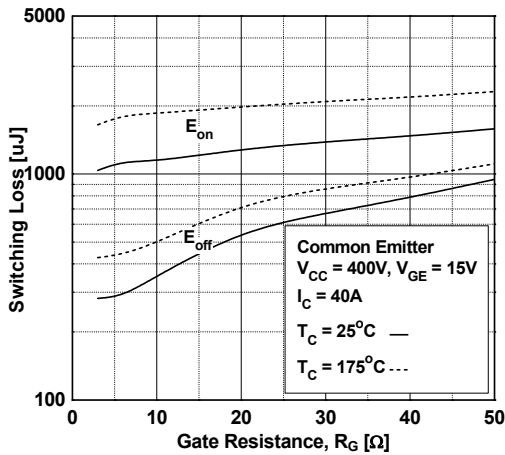
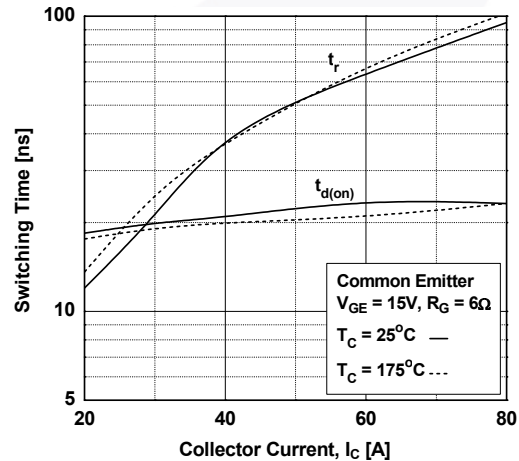

Figure 12. Turn-on Characteristics vs. Collector Current



Typical Performance Characteristics

Figure 13. Turn-off Characteristics vs. Collector Current

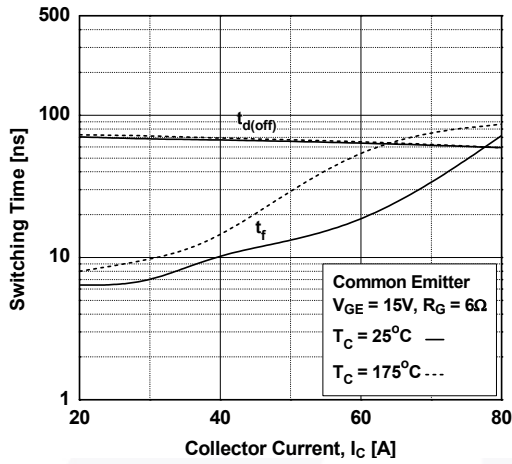

Figure 14. Switching Loss vs. Collector Current

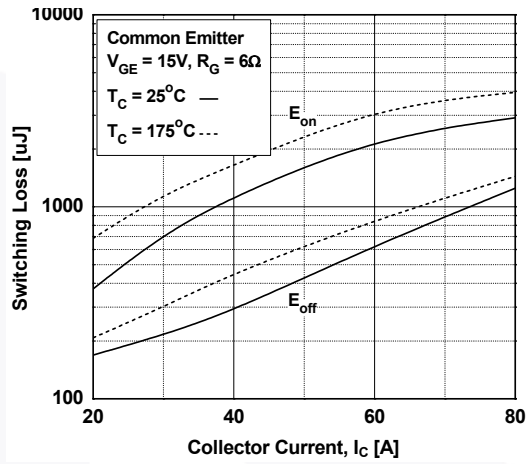

Figure 15. Load Current Vs. Frequency

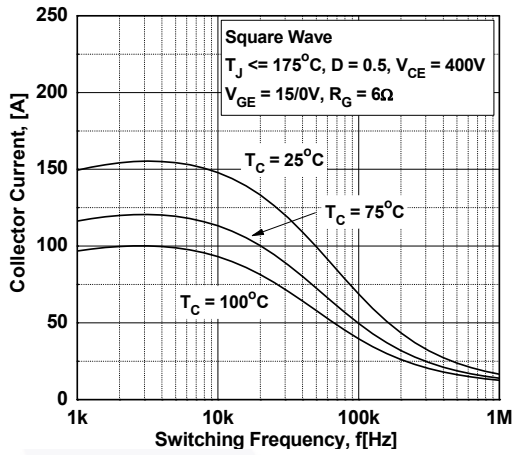

Figure 16. SOA Characteristics

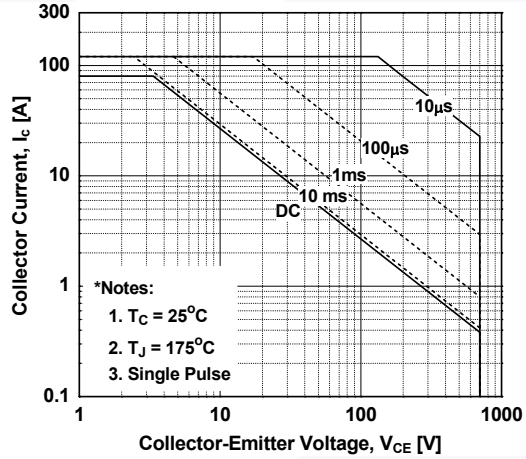

Figure 17. Forward Characteristics

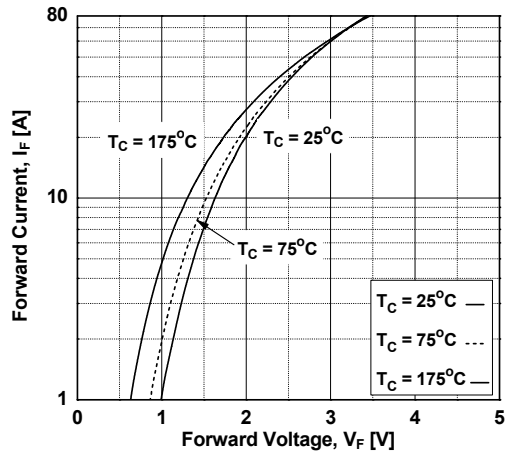
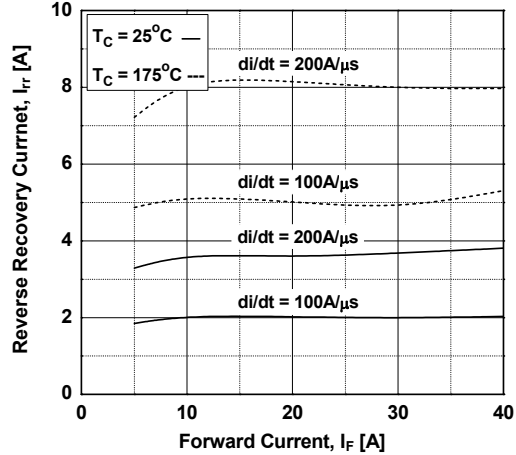

Figure 18. Reverse Recovery Current



Typical Performance Characteristics

Figure 19. Reverse Recovery Time

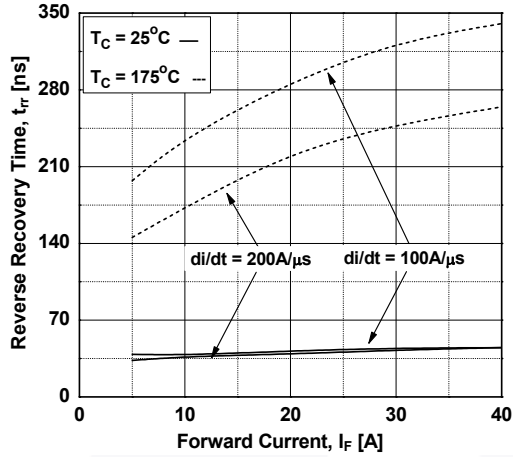

Figure 20. Stored Charge

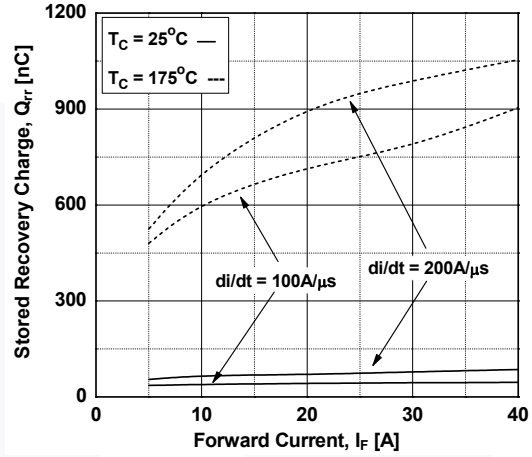

Figure 21. Transient Thermal Impedance of IGBT

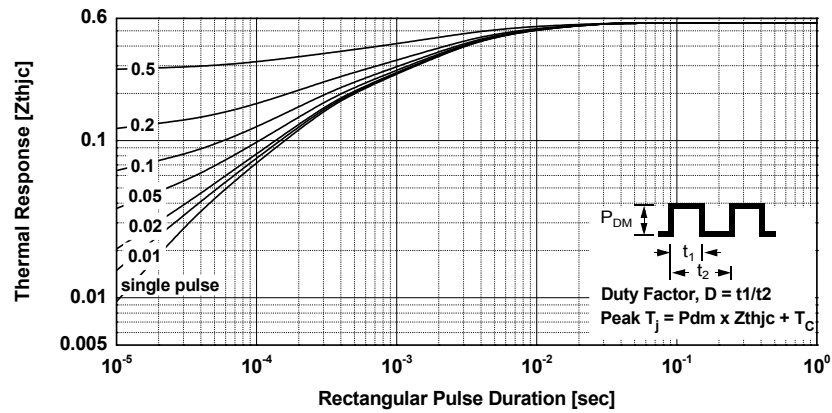
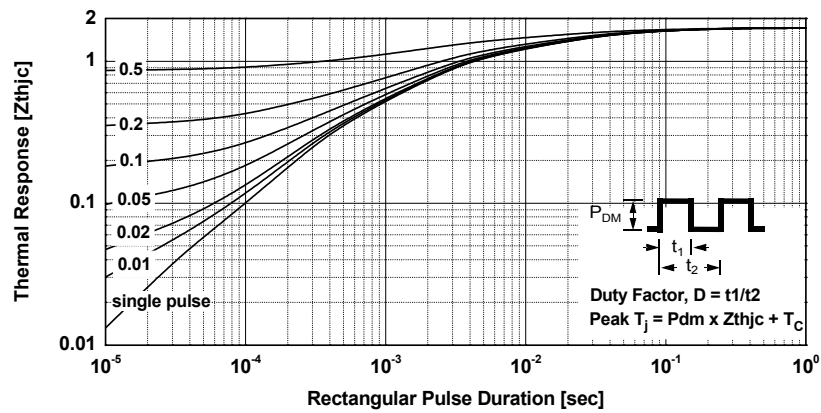
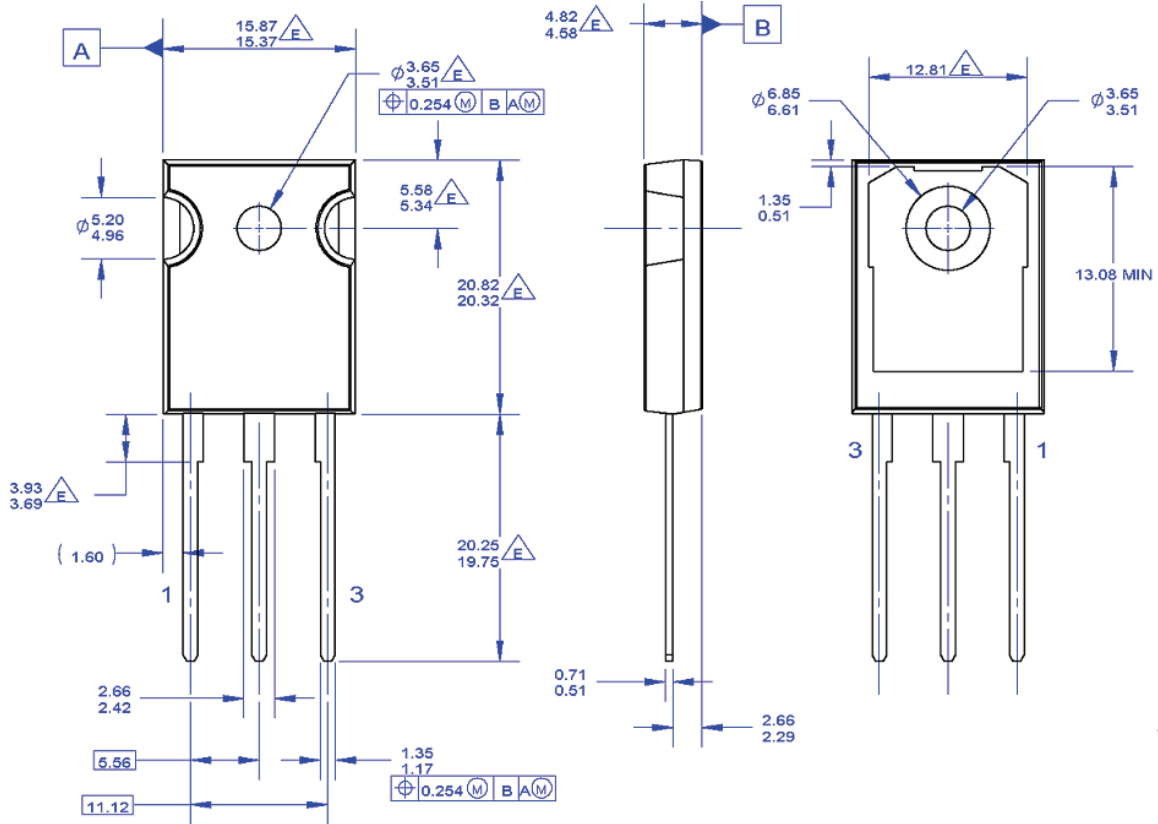

Figure 22. Transient Thermal Impedance of Diode



Mechanical Dimensions



- NOTES: UNLESS OTHERWISE SPECIFIED.
- A. PACKAGE REFERENCE: JEDEC TO-247, ISSUE E, VARIATION AB, DATED JUNE, 2004.
 - B. DIMENSIONS ARE EXCLUSIVE OF BURRS, MOLD FLASH, AND TIE BAR EXTRUSIONS.
 - C. ALL DIMENSIONS ARE IN MILLIMETERS.
 - D. DRAWING CONFORMS TO ASME Y14.5 - 1994
 - E. DOES NOT COMPLY JEDEC STANDARD VALUE
 - F. DRAWING FILENAME: MKT-TO247G03_REV01

Figure 23. TO-247 3L - TO-247, MOLDED, 3 LEADS, JEDEC AB LONG LEADS

Package drawings are provided as a service to customers considering Fairchild components. Drawings may change in any manner without notice. Please note the revision and/or date on the drawing and contact a Fairchild Semiconductor representative to verify or obtain the most recent revision. Package specifications do not expand the terms of Fairchild's worldwide terms and conditions, specifically the warranty therein, which covers Fairchild products.

Always visit Fairchild Semiconductor's online packaging area for the most recent package drawings:

http://www.fairchildsemi.com/package/packageDetails.html?id=PN_TO247-0A3



TRADEMARKS

The following includes registered and unregistered trademarks and service marks, owned by Fairchild Semiconductor and/or its global subsidiaries, and is not intended to be an exhaustive list of all such trademarks.

- | | | | |
|--------------------------|---|---------------------------------------|------------------|
| AccuPower™ | F-PFS™ | OPTOPLANAR® | |
| AttitudeEngine™ | FRFET® | | |
| Awinda® | Global Power ResourceSM | | TinyBoost® |
| AX-CAP®* | GreenBridge™ | Power Supply WebDesigner™ | TinyBuck® |
| BitSiC™ | Green FPS™ | PowerTrench® | TinyCalc™ |
| Build it Now™ | Green FPS™ e-Series™ | PowerXS™ | TinyLogic® |
| CorePLUS™ | Gmax™ | Programmable Active Droop™ | TINYOPTO™ |
| CorePOWER™ | GTO™ | QFET® | TinyPower™ |
| CROSSVOLT™ | IntelliMAX™ | QS™ | TinyPWM™ |
| CTL™ | ISOPLANAR™ | Quiet Series™ | TinyWire™ |
| Current Transfer Logic™ | Marking Small Speakers Sound Louder and Better™ | RapidConfigure™ | TranSiC™ |
| DEUXPEED® | MegaBuck™ | | TriFault Detect™ |
| Dual Cool™ | MICROCOUPLER™ | Saving our world, 1mW/W/kW at a time™ | TRUECURRENT®* |
| EcoSPARK® | MicroFET™ | SignalWise™ | μSerDes™ |
| EfficientMax™ | MicroPak™ | SmartMax™ | |
| ESBC™ | MicroPak2™ | SMART START™ | UHC® |
| | MillerDrive™ | Solutions for Your Success™ | Ultra FRFET™ |
| Fairchild® | MotionMax™ | SPM® | UniFET™ |
| Fairchild Semiconductor® | MotionGrid® | STEALTH™ | VCX™ |
| FACT Quiet Series™ | MTi® | SuperFET® | VisualMax™ |
| FACT® | MTx® | SuperSOT™-3 | VoltagePlus™ |
| FastvCore™ | MVN® | SuperSOT™-6 | XS™ |
| FETBench™ | mWSaver® | SuperSOT™-8 | Xsens™ |
| FPS™ | OptoHiT™ | SupreMOS® | 仙童® |
| | OPTOLOGIC® | SyncFET™ | |
| | | Sync-Lock™ | |

*Trademarks of System General Corporation, used under license by Fairchild Semiconductor.

DISCLAIMER

FAIRCHILD SEMICONDUCTOR RESERVES THE RIGHT TO MAKE CHANGES WITHOUT FURTHER NOTICE TO ANY PRODUCTS HEREIN TO IMPROVE RELIABILITY, FUNCTION, OR DESIGN. TO OBTAIN THE LATEST, MOST UP-TO-DATE DATASHEET AND PRODUCT INFORMATION, VISIT OUR WEBSITE AT [HTTP://WWW.FAIRCHILDSEMI.COM](http://www.fairchildsemi.com). FAIRCHILD DOES NOT ASSUME ANY LIABILITY ARISING OUT OF THE APPLICATION OR USE OF ANY PRODUCT OR CIRCUIT DESCRIBED HEREIN; NEITHER DOES IT CONVEY ANY LICENSE UNDER ITS PATENT RIGHTS, NOR THE RIGHTS OF OTHERS. THESE SPECIFICATIONS DO NOT EXPAND THE TERMS OF FAIRCHILD'S WORLDWIDE TERMS AND CONDITIONS, SPECIFICALLY THE WARRANTY THEREIN, WHICH COVERS THESE PRODUCTS.

AUTHORIZED USE

Unless otherwise specified in this data sheet, this product is a standard commercial product and is not intended for use in applications that require extraordinary levels of quality and reliability. This product may not be used in the following applications, unless specifically approved in writing by a Fairchild officer: (1) automotive or other transportation, (2) military/aerospace, (3) any safety critical application – including life critical medical equipment – where the failure of the Fairchild product reasonably would be expected to result in personal injury, death or property damage. Customer's use of this product is subject to agreement of this Authorized Use policy. In the event of an unauthorized use of Fairchild's product, Fairchild accepts no liability in the event of product failure. In other respects, this product shall be subject to Fairchild's Worldwide Terms and Conditions of Sale, unless a separate agreement has been signed by both Parties.

ANTI-COUNTERFEITING POLICY

Fairchild Semiconductor Corporation's Anti-Counterfeiting Policy. Fairchild's Anti-Counterfeiting Policy is also stated on our external website, www.fairchildsemi.com, under Terms of Use

Counterfeiting of semiconductor parts is a growing problem in the industry. All manufacturers of semiconductor products are experiencing counterfeiting of their parts. Customers who inadvertently purchase counterfeit parts experience many problems such as loss of brand reputation, substandard performance, failed applications, and increased cost of production and manufacturing delays. Fairchild is taking strong measures to protect ourselves and our customers from the proliferation of counterfeit parts. Fairchild strongly encourages customers to purchase Fairchild parts either directly from Fairchild or from Authorized Fairchild Distributors who are listed by country on our web page cited above. Products customers buy either from Fairchild directly or from Authorized Fairchild Distributors are genuine parts, have full traceability, meet Fairchild's quality standards for handling and storage and provide access to Fairchild's full range of up-to-date technical and product information. Fairchild and our Authorized Distributors will stand behind all warranties and will appropriately address and warranty issues that may arise. Fairchild will not provide any warranty coverage or other assistance for parts bought from Unauthorized Sources. Fairchild is committed to combat this global problem and encourage our customers to do their part in stopping this practice by buying direct or from authorized distributors.

PRODUCT STATUS DEFINITIONS

Definition of Terms

Datasheet Identification	Product Status	Definition
Advance Information	Formative / In Design	Datasheet contains the design specifications for product development. Specifications may change in any manner without notice.
Preliminary	First Production	Datasheet contains preliminary data; supplementary data will be published at a later date. Fairchild Semiconductor reserves the right to make changes at any time without notice to improve design.
No Identification Needed	Full Production	Datasheet contains final specifications. Fairchild Semiconductor reserves the right to make changes at any time without notice to improve the design.
Obsolete	Not In Production	Datasheet contains specifications on a product that is discontinued by Fairchild Semiconductor. The datasheet is for reference information only.