

Data Sheet

BD120U520-1305

Ultra Low Profile 1305 Balun

50Ω to 200Ω Balanced



Features:

- 1100~1300 MHz
- 0.85mm Height Profile
- 50Ohm to 2x100 Ohm
- High CMRR
- Low Insertion Loss
- Input to Output DC Isolation
- Surface Mountable
- Tape & Reel
- Non-conductive Surface
- RoHS Compliant

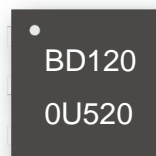
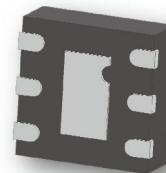

Applications

- WiMAX
- GPS
- UWB
- Bluetooth
- Zigbee
- GSM

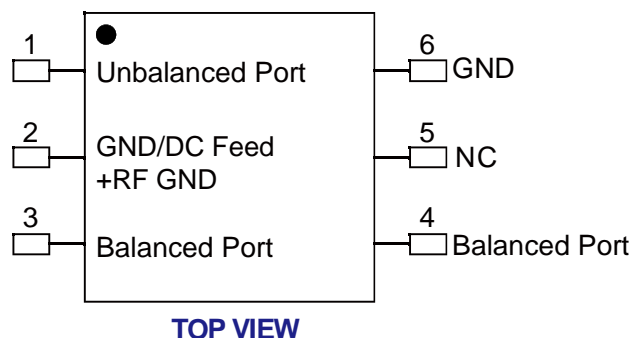

Electrical Specifications at 25° C

Parameter	Symbol	Min	Typ	Max	Unit
Frequency Range	F	1100		1300	MHz
Unbalanced Port Impedance			50		Ω
Balanced Port Impedance			200		Ω
Return Loss	RL		10		dB
Insertion Loss	IL		1.2	1.5	dB
Amplitude balance	Abal		0.3	0.5	dB
Phase balance	Φ bal		3	5	deg
CMRR			35		dB

Yantel Corporation

Add: 3F, Building 3, Southern District 2 of Zhongguan Honghualing Industrial Park, Xili, Nanshan, Shenzhen, China

Tel: 86-755-8355-1886 Fax: 86-755-8355-2533

Rev A1

For detailed performance specs & shopping online see Yantel web site : www.yantel-corp.com

Data Sheet

BD1200U520-1305

Ultra Low Profile 1305 Balun

50Ω to 200Ω Balanced



Typical Performance (25°C: 1000-1400 MHz)

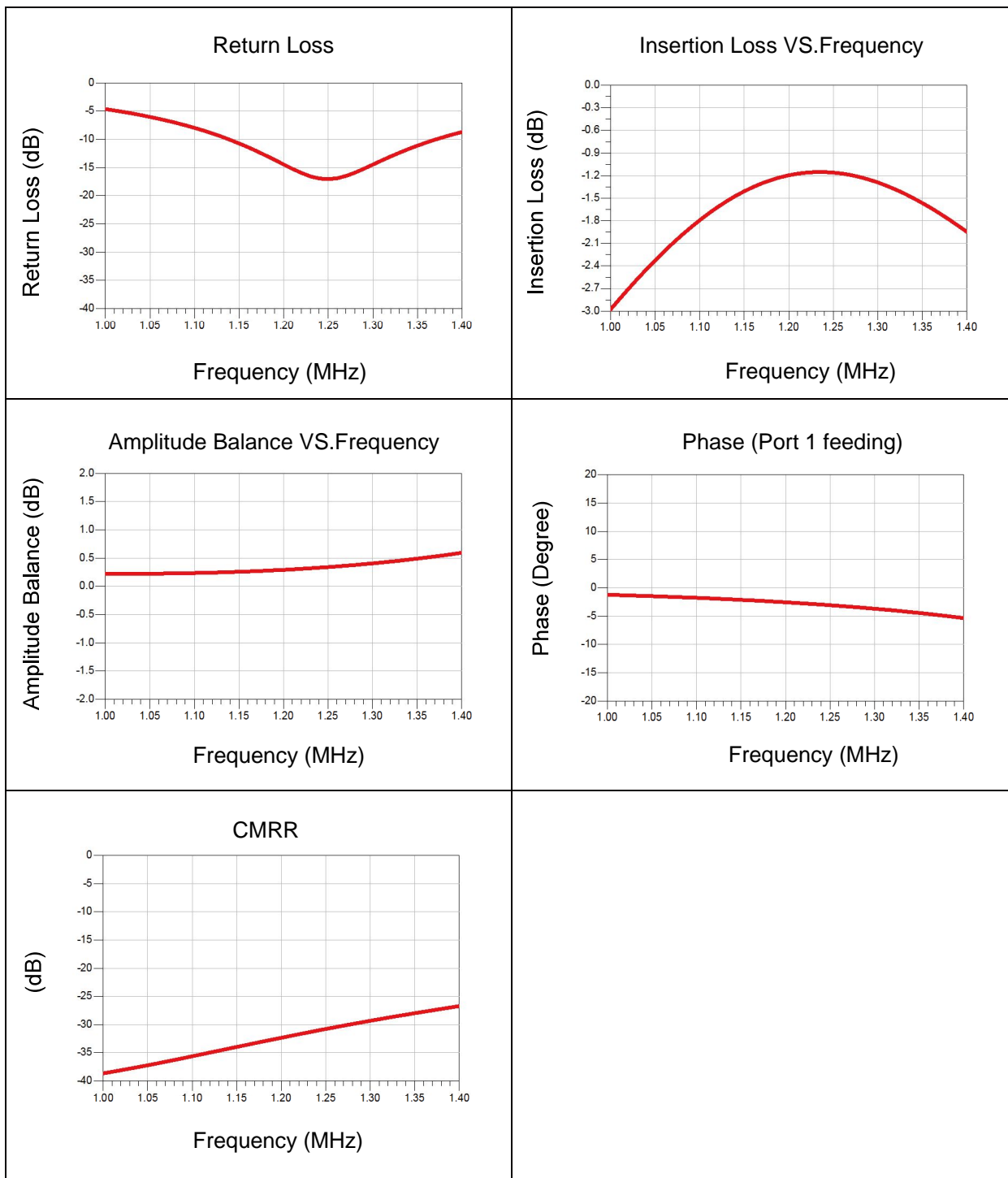

Yantel Corporation

Add: 3F, Building 3, Southern District 2 of Zhongguan Honghualing Industrial Park, Xili, Nanshan, Shenzhen, China
 Tel: 86-755-8355-1886 Fax: 86-755-8355-2533

Rev A1

For detailed performance specs & shopping online see Yantel web site : www.yantel-corp.com

Data Sheet

BD120U520-1305

Ultra Low Profile 1305 Balun

50Ω to 200Ω Balanced



Outline Drawing

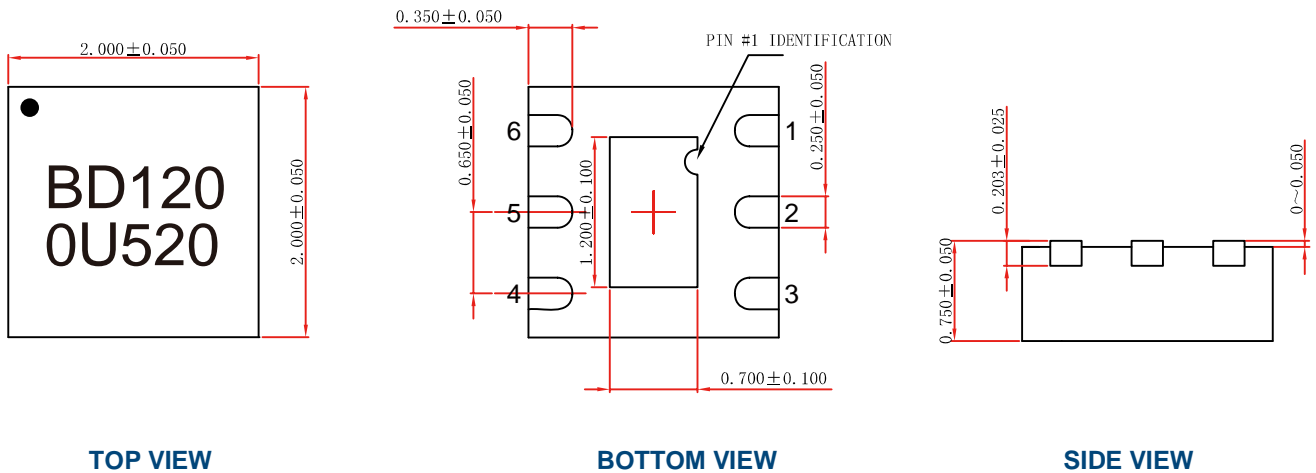

Land Pattern

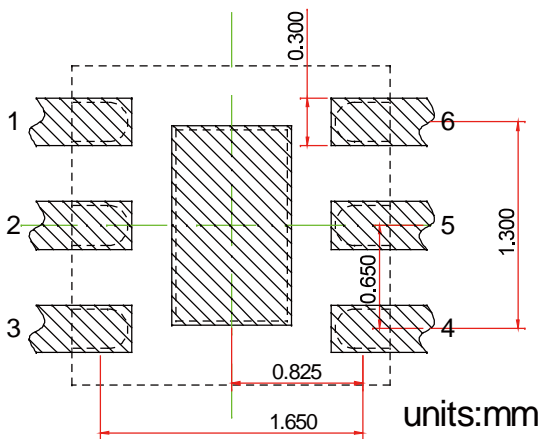

Recommended Land Pattern Top View

Notes: All dimensions show in millimeters

Pin Out

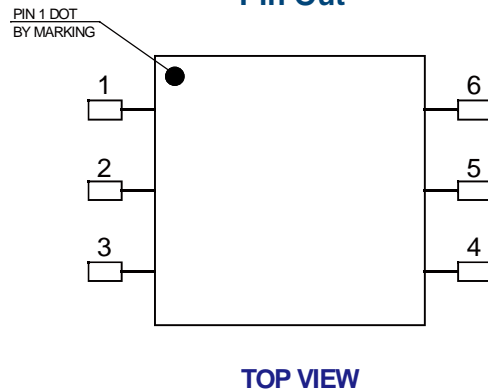

Pin #	Connection
1	Unbalanced Port
2	GND/DC Feed+RF GND
3	Balanced Port
4	Balanced Port
5	NC
6	GND

Yantel Corporation

Add: 3F, Building 3, Southern District 2 of Zhongguan Honghualing Industrial Park, Xili, Nanshan, Shenzhen, China
Tel: 86-755-8355-1886 Fax: 86-755-8355-2533

Rev A1

For detailed performance specs & shopping online see Yantel web site : www.yantel-corp.com