

## SOT-23 Plastic-Encapsulate Transistors

**SS8050** TRANSISTOR (NPN)

**FEATURES**

- Complementary to SS8550

**MARKING: Y1**
**MAXIMUM RATINGS ( $T_a=25^{\circ}\text{C}$  unless otherwise noted)**

Symbol	Parameter	Value	Unit
$V_{CB0}$	Collector-Base Voltage	40	V
$V_{CE0}$	Collector-Emitter Voltage	25	V
$V_{EBO}$	Emitter-Base Voltage	5	V
$I_C$	Collector Current-Continuous	1.5	A
$P_C$	Collector Power Dissipation	0.3	W
$R_{\theta JA}$	Thermal Resistance From Junction To Ambient	417	$^{\circ}\text{C}/\text{W}$
$T_j$	Junction Temperature	150	$^{\circ}\text{C}$
$T_{stg}$	Storage Temperature	-55~+150	$^{\circ}\text{C}$

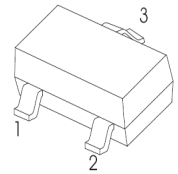
**SOT-23**

- BASE
- EMITTER
- COLLECTOR

**ELECTRICAL CHARACTERISTICS ( $T_a = 25^{\circ}\text{C}$  unless otherwise specified)**

Parameter	Symbol	Test conditions	Min	Typ	Max	Unit
Collector-base breakdown voltage	$V_{(BR)CBO}$	$I_C=100\mu\text{A}, I_E=0$	40			V
Collector-emitter breakdown voltage	$V_{(BR)CEO}$	$I_C=0.1\text{mA}, I_B=0$	25			V
Emitter-base breakdown voltage	$V_{(BR)EBO}$	$I_E=100\mu\text{A}, I_C=0$	5			V
Collector cut-off current	$I_{CBO}$	$V_{CB}=40\text{V}, I_E=0$			0.1	$\mu\text{A}$
Collector cut-off current	$I_{CEO}$	$V_{CE}=20\text{V}, I_E=0$			0.1	$\mu\text{A}$
Emitter cut-off current	$I_{EBO}$	$V_{EB}=5\text{V}, I_C=0$			0.1	$\mu\text{A}$
DC current gain	$h_{FE(1)}$	$V_{CE}=1\text{V}, I_C=100\text{mA}$	120		400	
	$h_{FE(2)}$	$V_{CE}=1\text{V}, I_C=800\text{mA}$	40			
Collector-emitter saturation voltage	$V_{CE(sat)}$	$I_C=100\text{mA}, I_B=5\text{mA}$			0.5	V
Base-emitter saturation voltage	$V_{BE(sat)}$	$I_C=100\text{mA}, I_B=5\text{mA}$			1.2	V
Transition frequency	$f_T$	$V_{CE}=10\text{V}, I_C=50\text{mA}, f=30\text{MHz}$	100			MHz

**CLASSIFICATION OF  $h_{FE(1)}$** 

Rank	L	H	J
Range	120-200	200-350	300-400

Typical Characteristics

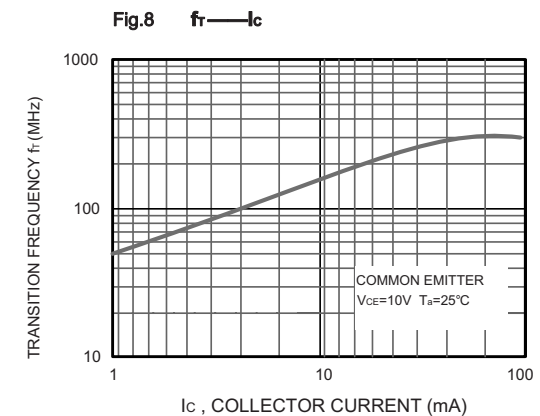
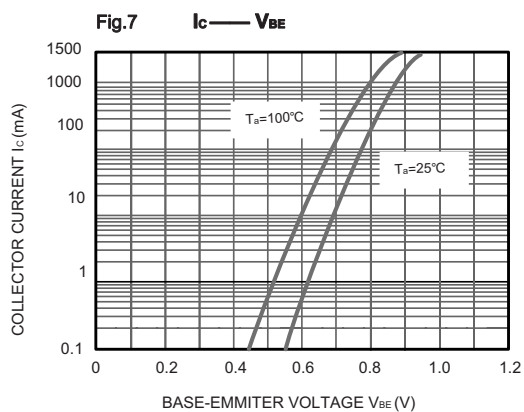
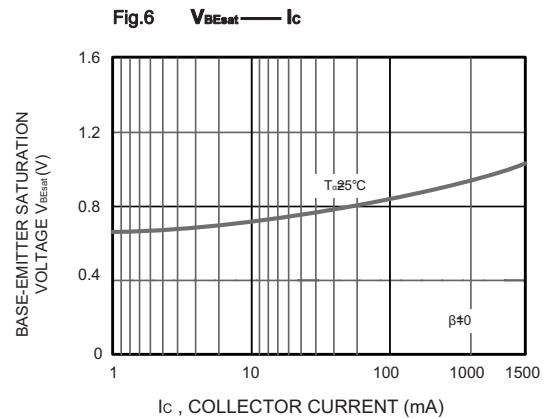
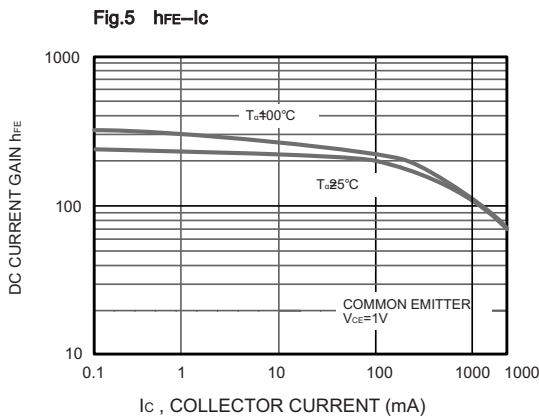
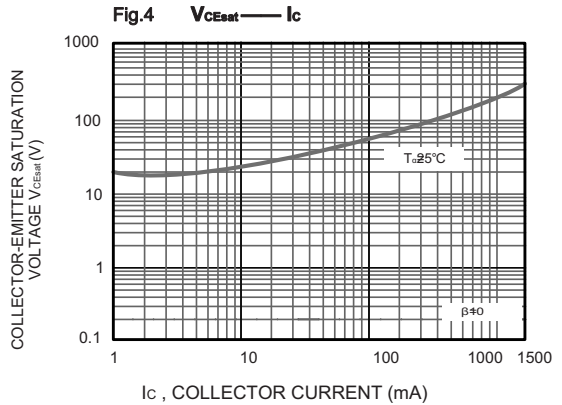
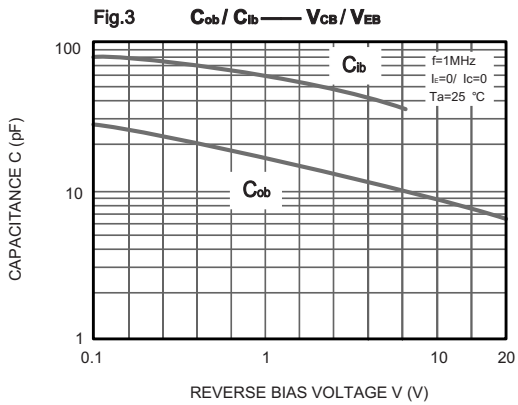
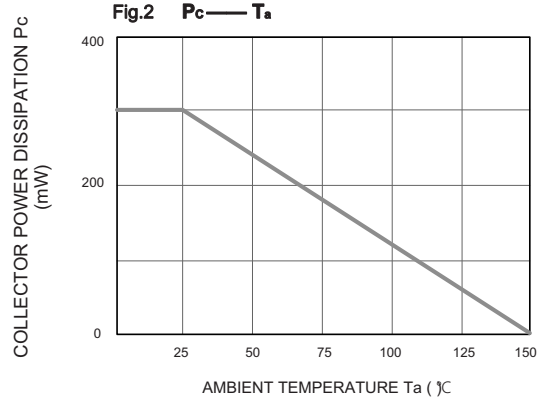
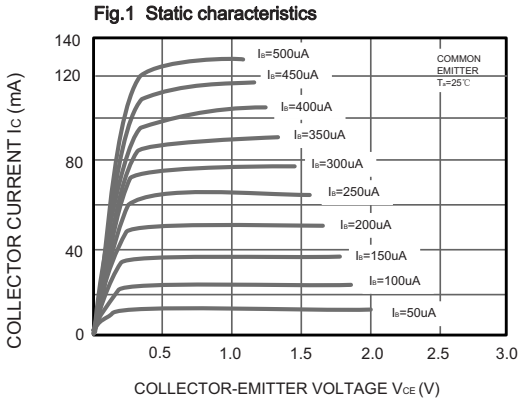

**Outline Drawing**

**SOT-23 Package Outline Dimensions**

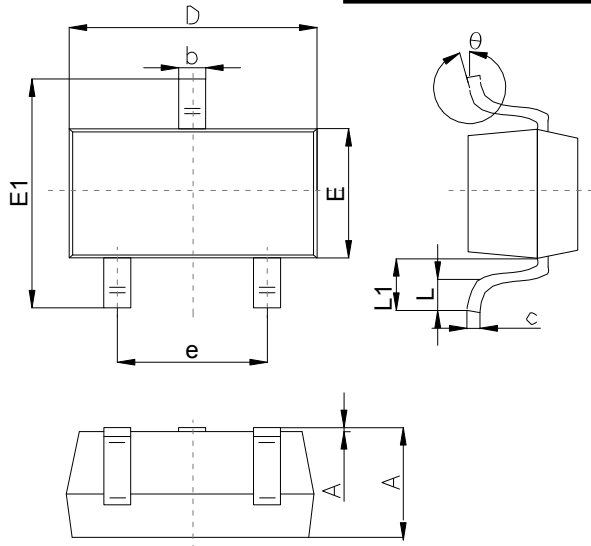

Symbol	Dimensions In Millimeters		
	Min	Typ	Max
A	0.90		1.40
A1	0.00		0.10
b	0.30		0.50
c	0.08		0.20
D	2.80	2.90	3.10
E	1.20		1.60
E1	2.25		2.80
e	1.80	1.90	2.00
L	0.10		0.50
L1	0.4		0.55
θ	0°		10°

**Suggested Pad Layout**

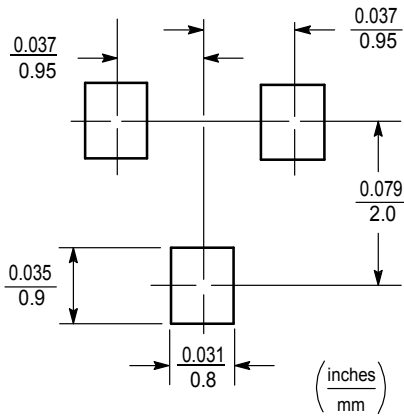

Note:

1. Controlling dimension:in/millimeters.
2. General tolerance: ±0.05mm.
3. The pad layout is for reference purposes only.

**SOT-23 Tape and Reel**

**SOT-23 Embossed Carrier Tape**

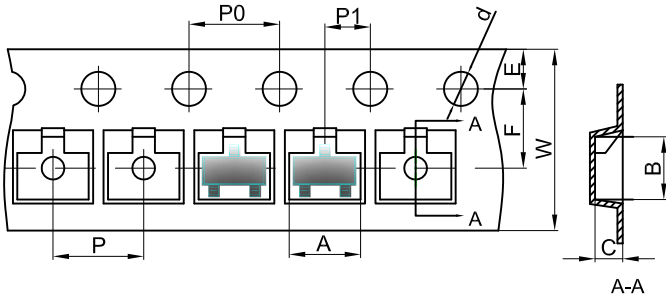

**Packaging Description:**

SOT-23 parts are shipped in tape. The carrier tape is made from a dissipative (carbon filled) polycarbonate resin. The cover tape is a multilayer film (Heat Activated Adhesive in nature) primarily composed of polyester film, adhesive layer, sealant, and anti-static sprayed agent. These reeled parts in standard option are shipped with 3,000 units per 7" or 17.8cm diameter reel. The reels are clear in color and is made of polystyrene plastic (anti-static coated).

Dimensions are in millimeter										
Pkg type	A	B	C	d	E	F	P0	P	P1	W
SOT-23	3.15	2.77	1.22	Ø1.50	1.75	3.50	4.00	4.00	2.00	8.00

**SOT-23 Tape Leader and Trailer**

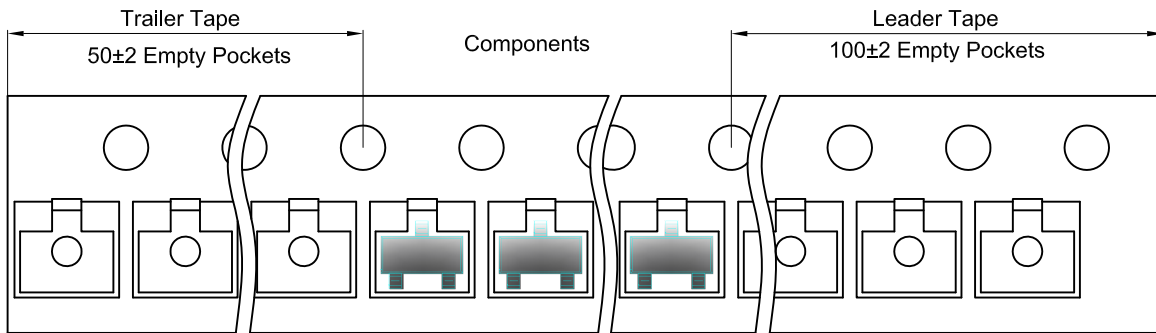

**SOT-23 Reel**

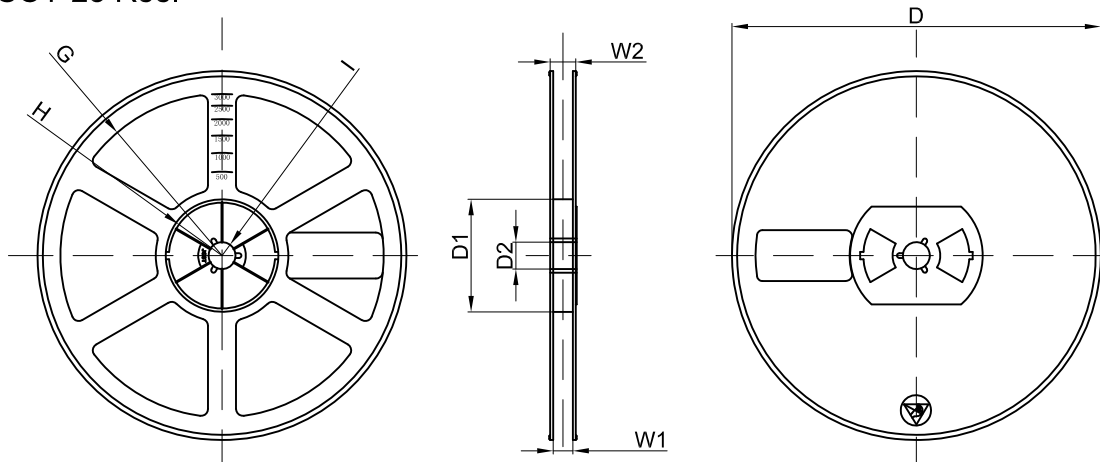

Dimensions are in millimeter								
Reel Option	D	D1	D2	G	H	I	W1	W2
7" Dia	Ø178.00	54.40	13.00	R78.00	R25.60	R6.50	9.50	12.30

REEL	Reel Size	Box	Box Size(mm)	Carton	Carton Size(mm)	G.W.(kg)
3000 pcs	7 Inch	45,000 pcs	203×203×195	180,000 pcs	438×438×220	