



Top Mounting T20 and T21 Liquid Level Switches

DESCRIPTION

T20 and T21 units are simple, reliable float switches, designed for top mounting into tanks or vessels. T20 units utilize a single switch mechanism and float. T21 tandem units utilize two switch mechanisms and two separate floats. T20 and T21 models are available for any type of open or closed vessel, with either threaded or flanged type mounting, and actuating depths of up to 48 inches (1219 mm).

FEATURES

- Float diameters of 3" x 5", 4" and 4½" available
- Tank connections available in 1" NPT, cast iron, forged, or stainless steel flanges
- Choice of switch mechanism:
 - Dry contact
 - Hermetically sealed
 - Pneumatic
- Choice of switch enclosure:
 - NEMA 1 carbon steel for pneumatics
 - TYPE 4X/7/9 Class I, Div. 1, Groups C & D, polymer coated aluminum
 - TYPE 4X/7/9 Class I, Div. 1, Group B, polymer coated aluminum

APPLICATIONS

- Day tanks
- Condensate receivers
- Fuel storage tanks
- Cooling towers
- Flash tanks
- Interface
- High and high/high alarm from single tank entry



OPTIONS

- NACE
- ATEX approved housing
- Housing heater
- Float guide cage
- Tropicalized switch mechanism
- Special flange face finishes
- Submersible housing
- Elevated temperature

TECHNOLOGY

A permanent magnet ① is attached to a pivoted switch actuator and adjustment screw ②. As the float ③ rises following the liquid level, it raises the attraction sleeve ④ into the field of the magnet, which then snaps against the non-magnetic enclosing tube ⑤, actuating the switch ⑥. The enclosing tube provides a static pressure boundary between the switch mechanism and the process. On a falling level, an inconel spring retracts the magnet, deactivating the switch.

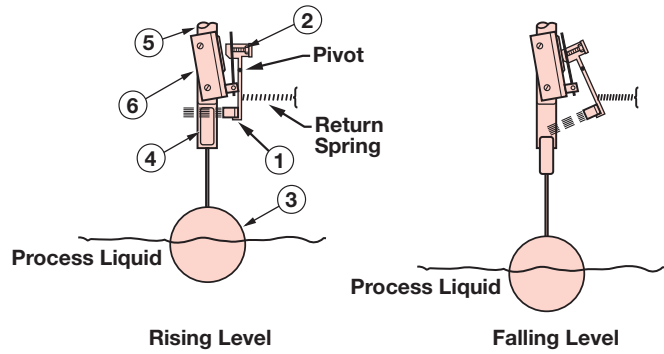



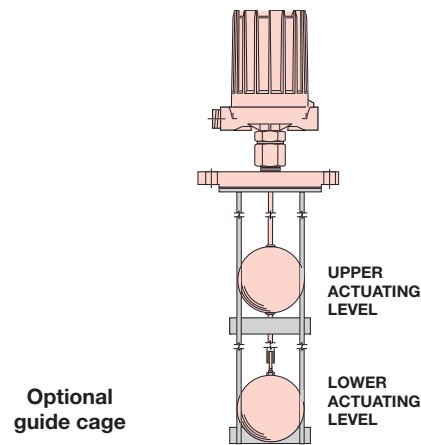

T21 TANDEM MODELS

T21 tandem models combine the functions of two separate narrow differential level controls in a single, compact, easy to install instrument. Two individual switch mechanisms are employed to provide two actuating levels at least 8" apart. These instruments are ideally used in applications requiring two separate switching points, such as high and low level alarm operation.

Model T21 tandem float switches are available with an optional cage to help stabilize the floats under turbulent conditions. Consult your local representative for ordering information.



AGENCY APPROVALS

AGENCY	MODEL APPROVED	APPROVAL CLASSES
FM  APPROVED	All with an electric switch mechanism and a housing listed as TYPE 4X/7/9	Class I, Div 1, Groups C & D Class II, Div 1, Groups E, F & G
	All with an electric switch mechanism and a housing listed as TYPE 4X/7/9 Class I, Div 1, Group B	Class I, Div 1, Groups B, C & D Class II, Div 1, Groups E, F & G
CSA 	All with a Series F, HS, H1, 8 or 9 electric switch mechanism and a housing listed as CSA TYPE 4X	Class I, Div 2, Groups B, C & D
	All with an electric switch mechanism and a housing listed as TYPE 4X/7/9	Class I, Div 1, Groups C & D Class II, Div 1, Groups E, F & G
	All with an electric switch mechanism and a housing listed as TYPE 4X/7/9 Class I, Div 1, Group B	Class I, Div 1, Groups B, C & D Class II, Div 1, Groups E, F & G
ATEX / IEC Ex ① 	All with an electric switch mechanism and an ATEX housing ①	ATEX II 2 G EEx d IIC T6 94/9/EC IEC Ex Ex d IIC T6 IP 66
CE 	Low Voltage Directives 2006/95/EC Per Harmonized Standard: EN 61010-1/1993 & Amendment No. 1	Installation Category II Pollution Degree 2

① Dual stage units with 'HS' or 'H1' switches are not ATEX approved.

SPECIFICATIONS

SWITCH MECHANISMS AND ENCLOSURES



SERIES B, C, D & R DRY CONTACT SWITCHES

- Designed for AC and DC current applications
- Process temperatures to +1000° F (+538° C)



SERIES HS, H1, 8 & 9 HERMETICALLY SEALED SWITCHES

- Ideal for use in salt and other corrosive atmospheres
- HS & H1 are positively pressurized capsules for entire mechanism and contacts
- Process temperatures to +1000° F (+538° C)



SERIES J & K PNEUMATIC SWITCHES

- Suited for applications where electrical power is not available
- Bleed and non-bleed designs
- Process temperatures to +400° F (+204° C)



SWITCH ENCLOSURES

- TYPE 4X/7/9 aluminum enclosures
- Designed to meet Class I, Div. 1, Groups C & D and Class I, Div. 1 Group B
- Optional housing heaters and drains available for some enclosures
- Pneumatic switch mechanisms available with a NEMA 1 enclosure

BASIC ELECTRICAL RATINGS

Voltage	Switch Series and Non-Inductive Ampere Rating								
	B	C	D	F	HS	H1	R	8	9
120 VAC	15.00	15.00	10.00	0.25	5.00	1.00	1.00	1.00	—
240 VAC	15.00	15.00	—	—	5.00	1.00	1.00	—	—
24 VDC	6.00	10.00	10.00	4.00	5.00	1.00	1.00	3.00	0.50
120 VDC	0.50	1.00	10.00	0.30	0.50	0.40	0.40	—	—
240 VDC	0.25	0.50	3.00	—	0.25	—	—	—	—

DIMENSIONAL SPECIFICATIONS

INCHES (mm)

Housing ①	A	B	Conduit Connections
TYPE 4X/7/9 Group B	5.93 (151)	3.87 (98)	1" NPT dual entry
NEMA 1 ② Pneumatics	4.70 (119)	5.00 (127)	¼" NPT single entry

① All housings rotatable 360°.

② Pneumatic switches available with Series T20 units only.

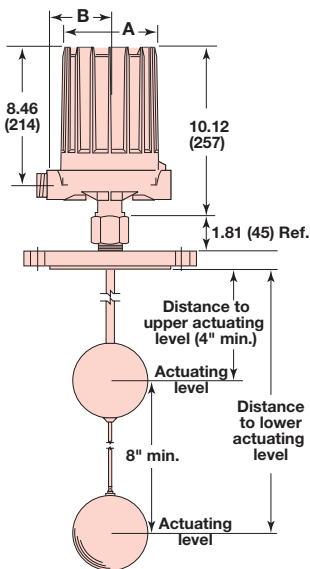

Model T21 with flange

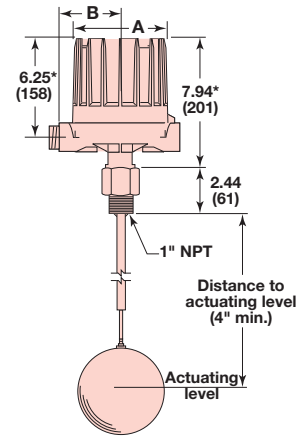

Model T20 with 1" NPT

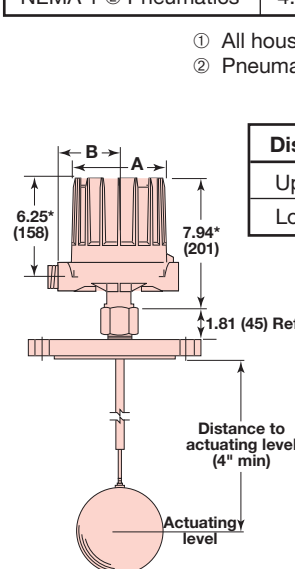

Model T20 with flange

Distance To	Maximum	Minimum
Upper level	40" (1016)	4" (102)
Lower level	48" (1219)	12" (305)

NOTE: On Model T21 the lower float actuates upper switch mechanism. The upper float actuates the lower switch mechanism.

* These dimensions increase by 2.19 (55) when unit is supplied with an HS switch with terminal block.

MODEL NUMBER

T20 SINGLE SWITCH



Models available for quick shipment, usually within one week after factory receipt of a complete purchase order, through the Expedite Ship Plan (ESP)

IMPORTANT: Actuating level(s), in either the rising or falling state, and specific gravity must be provided upon placement of order.

MODEL NUMBER CODE AND MATERIALS OF CONSTRUCTION

Model No.	Set Points	Tank Connection	Float and Trim	Sleeve
T20-1	1—Single float	Carbon steel	300 Series SS	400 Series SS
T20-4		316 SS	316 SS	316 SS

IMPORTANT: The maximum available insertion depth is governed by the liquid specific gravity and selected float size as given in the table below. The minimum insertion depth is four inches.

MAXIMUM INSERTION LENGTH inches (mm) FLOAT PRESSURE RATINGS

Liquid Specific Gravity	Float Size		
	3.00 x 5.00 (76 x 127)	4.00 (102)	4.50 (114)
1.00	39 (991)	48 (1219)	48 (1219)
0.90	20 (508)	33 (838)	48 (1219)
0.80	—	11 (279)	48 (1219)
0.70	—	—	38 (965)
0.60	—	—	6 (152)

Float Size Inches (mm)	Pressure Rating PSIG (bar)			
	100° F (38° C)	750° F (399° C)	900° F (482° C)	1000° F (538° C)
3.00 x 5.00 (76 x 127)	500 (34)	377 (26)	353 (24)	335 (23)
4.00 (102)	600 (41)	483 (33)	465 (32)	459 (32)
4.50 (114)	500 (34)	403 (28)	388 (27)	383 (26)

TANK CONNECTION AND FLOAT SIZE

Tank Connection ①	Float Diameter		
	3.00 x 5.00 (76 x 127)	4.00 (102)	4.50 (114)
1" NPT	B2A	B2B	B2C
4" 125 lb. C.I. flange ② ③	H2A	—	—
4" 150 lb. F.S. flange	H3A	—	—
5" 125 lb. C.I. flange ② ③	J2A	J2B	J2C
5" 150 lb. F.S. flange	J3A	J3B	J3C
6" 125 lb. C.I. flange ② ③	K2A	K2B	K2C
6" 150 lb. F.S. flange	K3A	K3B	K3C
6" 300 lb. F.S. flange	—	—	K4C ④

- ① Flanges are ANSI standard threaded onto 1" NPT bushing. Forged steel flanges have standard raised face.
- ② Not available with Model T20-4.
- ③ Available only in cast iron.
- ④ Available with material option code 1 only. C/F for stainless steel construction.
- ⑤ Process temperature based on +100° F (+38° C) ambient.
- ⑥ Uncontrolled housing heater or drain available in TYPE 4X/7/9 enclosure.
- ⑦ Consult factory for TYPE 4X/7/9 cast iron housings.
- ⑧ On steam applications, temperature down-rated to +400° F (+204° C) process at +100° F (+38° C) ambient.
- ⑨ CSA approval does not apply to Series HE switches.



ELECTRIC SWITCH MECHANISM AND ENCLOSURE

Switch Description	Process ⁵ Temperature Range °F (°C)	Contacts	Set Points	T20-1 Models			T20-4 Models		
				TYPE 4X/7/9 Aluminum Enclosure ^{6,7}					
				Class I, Div 1 Groups C&D	Class I, Div 1 Group B	ATEX Ex II 2 G EEx d IIC T6	Class I, Div 1 Groups C&D	Class I, Div 1 Group B	ATEX Ex II 2 G EEx d IIC T6
Series B Snap Switch	-40 to +250 (-40 to +121)	SPDT	1	BKP	BKT	BAC	BKQ	BKS	BA9
		DPDT	1	BNP	BNT	BBC	BNQ	BNS	BB9
Series C Snap Switch	-40 to +450 (-40 to +232)	SPDT	1	CKP	CKT	CAC	CKQ	CKS	CA9
		DPDT	1	CNP	CNT	CBC	CNQ	CNS	CB9
Series D DC Current Snap Switch	-40 to +250 (-40 to +121)	SPDT	1	N/A			DKQ	BKS	DA9
		DPDT	1	N/A			DNQ	DNS	DB9
Series F Hermetically Sealed Snap Switch	-50 to +750 (-46 to +399)	SPDT	1	FKP	FKT	FAC	FKQ	FSS	FA9
		DPDT	1	FNP	FNT	FBC	FNQ	FNS	FB9
Series HS Hermetically Sealed 5-amp Snap Switch with Wiring Leads	-50 to +550 ⁸ (-46 to +288)	SPDT	1	HMC	HEK ⁹	N/A	HMC	HEK ⁹	N/A
		DPDT	1	HMF	HET ⁹		HMF	HET ⁹	
Series HS Hermetically Sealed 5-amp Snap Switch with Terminal Block	-50 to +550 ⁸ (-46 to +288)	SPDT	1	HM3	HM4	HA9	HM3	HM4	HA9
		DPDT	1	HM7	HM8	HB9	HM7	HM8	HB9
Series H1 Hermetically Sealed 1-amp Snap Switch with Wiring Leads	-50 to +750 (-46 to +399)	SPDT	1	HKC	N/A		HKC	N/A	
Series R High Temperature Snap Switch	-40 to +750 (-40 to +399)	SPDT	1	RKQ	RKS	RA9	RKQ	RKS	RA9
		DPDT	1	RNQ	RNS	RB9	RNQ	RNS	RB9
Series 8 Hermetically Sealed Snap Switch	-50 to +750 (-46 to +399)	SPDT	1	8KP	8KT	8AC	8KQ	8KS	8A9
		DPDT	1	8NP	8NT	8BC	8NQ	8NS	8B9
Series 9 High Temperature Hermetically Sealed Snap Switch	-50 to +750 (-46 to +399)	SPDT	1	9KP	9KT	9AC	9KQ	9KS	9A9
		DPDT	1	9NP	9NT	9BC	9NQ	9NS	9B9
Switch Description	Process ⁵ Temp. Range °F (°C)	Contacts	Set Points	CS/Aluminum	Cast Iron		CS/Aluminum	Cast Iron	
				NEMA 4X	Class I, Div 1 Groups C&D	Class I, Div 1 Group B	NEMA 4X	Class I, Div 1 Groups C&D	Class I, Div 1 Group B
Series R High Temperature Snap Switch	-40 to +1000 (-40 to +538)	SPDT	1	R1Y	RKY	RKW	R1Y	RKY	RKW
		DPDT	1	RDY	RNY	RNW	RDY	RNY	RNW
Series 9 High Temperature Hermetically Sealed Snap Switch	-50 to +1000 (-46 to +538)	SPDT	1	9AR	9KR	9KV	9AY	9KY	9KW
		DPDT	1	9DR	9NR	9NV	9DY	9NY	9NW

PNEUMATIC SWITCH MECHANISM AND ENCLOSURE

Switch Description	Maximum Supply Pressure	Maximum Process Temperature	Bleed Orifice Diameter	NEMA 1
Series J Bleed Type	100 psig (7 bar)	400° F (204° C)	.063 (1.6 mm)	JDE
	60 psig (4 bar)		.094 (2.4 mm)	JEE
	100 psig (7 bar)	700° F (371° C)	.055 (1.4 mm)	JFE
Series K Non-Bleed	100 psig (7 bar)	400° F (204° C)	—	KOE
	40 psig (3 bar)		—	KOG



MODEL NUMBER

T21 TANDEM SWITCH

IMPORTANT: Actuating level(s), in either the rising or falling state, and specific gravity must be provided upon placement of order.

MODEL NUMBER CODE AND MATERIALS OF CONSTRUCTION

Model No.	Set Points	Tank Connection	Float and Trim	Sleeve
T21-1	2—Tandem float	Carbon steel	300 Series SS	400 Series SS
T21-4		316 SS	316 SS	316 SS

IMPORTANT: The maximum available insertion depth is governed by the liquid specific gravity and selected float size as given in the table below. The minimum insertion depth is four inches. The minimum distance between the top and bottom insertion depths is eight inches.

MAXIMUM INSERTION LENGTH inches (mm) FLOAT PRESSURE RATINGS

Liquid Specific Gravity	Float Size					
	3.00 x 5.00 (76 x 127)		4.00 (102)		4.50 (114)	
	Upper	Lower	Upper	Lower	Upper	Lower
1.00	21 (533)	48 (1219)	32 (813)	48 (1219)	40 (1016)	48 (1219)
0.90	9 (229)	30 (762)	18 (457)	44 (1118)	40 (1016)	48 (1219)
0.80	—	—	4 (102)	21 (533)	40 (1016)	48 (1219)
0.70	—	—	—	—	21 (533)	48 (1219)

Float Size Inches (mm)	Pressure Rating PSIG (bar)			
	100° F (38° C)	750° F (399° C)	900° F (482° C)	1000° F (538° C)
3.00 x 5.00 (76 x 127)	500 (34)	377 (26)	353 (24)	335 (23)
4.00 (102)	600 (41)	483 (33)	465 (32)	459 (32)
4.50 (114)	500 (34)	403 (28)	388 (27)	383 (26)

TANK CONNECTION AND FLOAT SIZE

Tank Connection ①	Float Diameter		
	3.00 x 5.00 (76 x 127)	4.00 (102)	4.50 (114)
4" 125 lb. C.I. flange ② ③	H2A	—	—
4" 150 lb. F.S. flange	H3A	—	—
5" 125 lb. C.I. flange ② ③	J2A	J2B	J2C
5" 150 lb. F.S. flange	J3A	J3B	J3C
6" 125 lb. C.I. flange ② ③	K2A	K2B	K2C
6" 150 lb. F.S. flange	K3A	K3B	K3C
6" 300 lb. F.S. flange	—	—	K4C

- ① Flanges are ANSI standard. Forged steel flanges have standard raised face.
- ② Not available with -4 Materials of Construction.
- ③ Available only in cast iron.
- ④ Process temperature based on +100° F (+38° C) ambient.
- ⑤ Uncontrolled housing heater or drain available in TYPE 4X/7/9 enclosure.
- ⑥ Consult factory for TYPE 4X/7/9 cast iron housings.
- ⑦ On steam applications, temperature down-rated to +400° F (+204° C) process at +100° F (+38° C) ambient.



ELECTRIC SWITCH MECHANISM AND ENCLOSURE

Switch Description	Process ④ Temperature Range °F (°C)	Contacts	Set Points	T21-1 Models			T21-4 Models		
				TYPE 4X/7/9 Aluminum Enclosure ⑤⑥					
				Class I, Div 1 Groups C&D	Class I, Div 1 Group B	ATEX Ex II 2 G EEx d IIC T6	Class I, Div 1 Groups C&D	Class I, Div 1 Group B	ATEX Ex II 2 G EEx d IIC T6
Series B Snap Switch	-40 to +250 (-40 to +121)	SPDT	2	BLA	BLJ	BDC	BLB	BLK	BD9
		DPDT	2	BOA	BOJ	BGC	BOB	BOK	BG9
Series C Snap Switch	-40 to +450 (-40 to +232)	SPDT	2	CLA	CLJ	CDC	CLB	CLK	CD9
		DPDT	2	COA	COJ	CGC	COB	COK	CG9
Series D DC Current Snap Switch	-40 to +250 (-40 to +121)	SPDT	2	DLB	DLK	DD9	DLB	DLK	DD9
		DPDT	2	DOB	DOK	DG9	DOB	DOK	DG9
Series F Hermetically Sealed Snap Switch	-50 to +750 (-46 to +399)	SPDT	2	FLA	FLJ	FDC	FLB	FLK	FD9
		DPDT	2	FOA	FOJ	FGC	FOB	FOK	FG9
Series HS Hermetically Sealed 5-amp Snap Switch with Wiring Leads	-50 to +550 ⑦ (-46 to +288)	SPDT	2	HMN	HMP	N/A	HMN	HMP	N/A
		DPDT	2	HMY	HMZ		HMY	HMZ	
Series H1 Hermetically Sealed 1-amp Snap Switch with Wiring Leads	-50 to +750 (-46 to +399)	SPDT	2	HKN	HKP	N/A	HKN	HKP	N/A
Series R High Temperature Snap Switch	-40 to +750 (-40 to +399)	SPDT	2	RLB	RLK	RD9	RLB	RLK	RD9
		DPDT	2	ROB	ROK	RG9	ROB	ROK	RG9
Series 8 Hermetically Sealed Snap Switch	-50 to +750 (-46 to +399)	SPDT	2	8LA	8LJ	8DC	8LB	8LK	8D9
		DPDT	2	8OA	8OJ	8GC	8OB	8OK	8G9
Series 9 High Temperature Hermetically Sealed Snap Switch	-50 to +750 (-46 to +399)	SPDT	2	9LA	9LJ	9DC	9LB	9LK	9D9
		DPDT	2	9OA	9OJ	9GC	9OB	9OK	9G9
Switch Description	Process ④ Temp. Range °F (°C)	Contacts	Set Points	CS/Aluminum	Cast Iron		CS/Aluminum	Cast Iron	
				NEMA 4X	Class I, Div 1 Groups C&D	Class I, Div 1 Group B	NEMA 4X	Class I, Div 1 Groups C&D	Class I, Div 1 Group B
Series R High Temperature Snap Switch	-40 to +1000 (-40 to +538)	SPDT	2	R3M	RLM	RLW	R3M	RLM	RLW
		DPDT	2	REM	ROM	ROW	REM	ROM	ROW
Series 9 High Temperature Hermetically Sealed Snap Switch	-50 to +1000 (-46 to +538)	SPDT	2	9BD	9LD	9LV	9BM	9LM	9LW
		DPDT	2	9ED	9OD	9OV	9EM	9OM	9OW

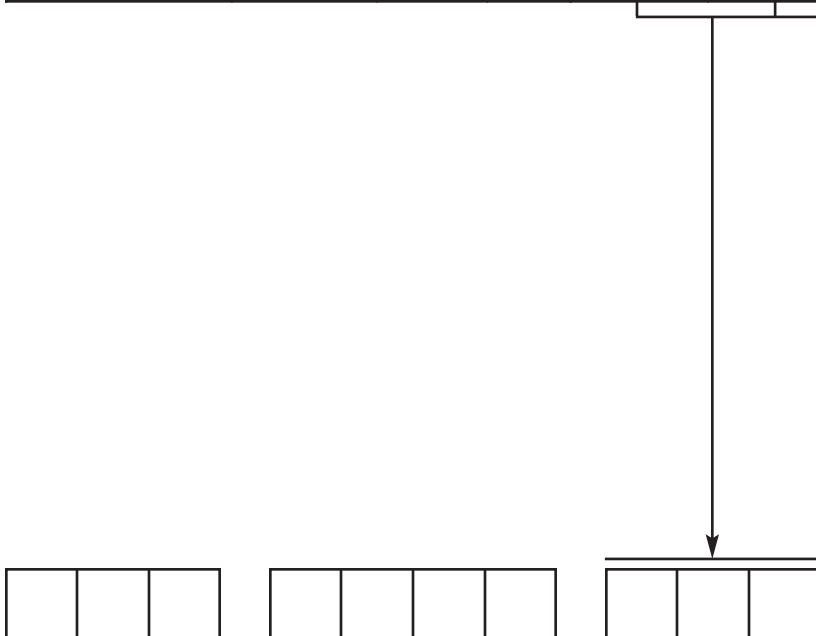

QUALITY



The quality assurance system in place at Magnetrol guarantees the highest level of quality throughout the company. Magnetrol is committed to providing full customer satisfaction both in quality products and quality service.

The Magnetrol quality assurance system is registered to ISO 9001 affirming its commitment to known international quality standards providing the strongest assurance of product/service quality available.

ESP

Expedite **S**hip **P**lan

Several Liquid Level Switches are available for quick shipment, usually within one week after factory receipt of a complete purchase order, through the Expedite Ship Plan (ESP).

To take advantage of ESP, match the color coded model number codes in the selection charts (standard dimensions apply).

ESP service may not apply to orders of ten units or more. Contact your local representative for lead times on larger volume orders, as well as other products and options.

WARRANTY



All Magnetrol mechanical level and flow controls are warranted free of defects in materials or workmanship for five full years from the date of original factory shipment.

If returned within the warranty period; and, upon factory inspection of the control, the cause of the claim is determined to be covered under the warranty; then, Magnetrol will repair

or replace the control at no cost to the purchaser (or owner) other than transportation.

Magnetrol shall not be liable for misapplication, labor claims, direct or consequential damage or expense arising from the installation or use of equipment. There are no other warranties expressed or implied, except special written warranties covering some Magnetrol products.



5300 Belmont Road • Downers Grove, Illinois 60515-4499 • 630-969-4000 • Fax 630-969-9489 • www.magnetrol.com
145 Jardin Drive, Units 1 & 2 • Concord, Ontario Canada L4K 1X7 • 905-738-9600 • Fax 905-738-1306
Heikensstraat 6 • B 9240 Zele, Belgium • 052 45.11.11 • Fax 052 45.09.93
Regent Business Ctr., Jubilee Rd. • Burgess Hill, Sussex RH15 9TL U.K. • 01444-871313 • Fax 01444-871317

Copyright © 2011 Magnetrol International, Incorporated. All rights reserved. Printed in the USA.
Performance specifications are effective with date of issue and are subject to change without notice.
Magnetrol & Magnetrol logotype are registered trademarks of Magnetrol International.

BULLETIN: 44-117.21
EFFECTIVE: May 2010
SUPERSEDES : September 2009