

SHINDENGEN

Schottky Rectifiers (SBD)

Single

S5S4M

40V 5A

OUTLINE DIMENSIONS

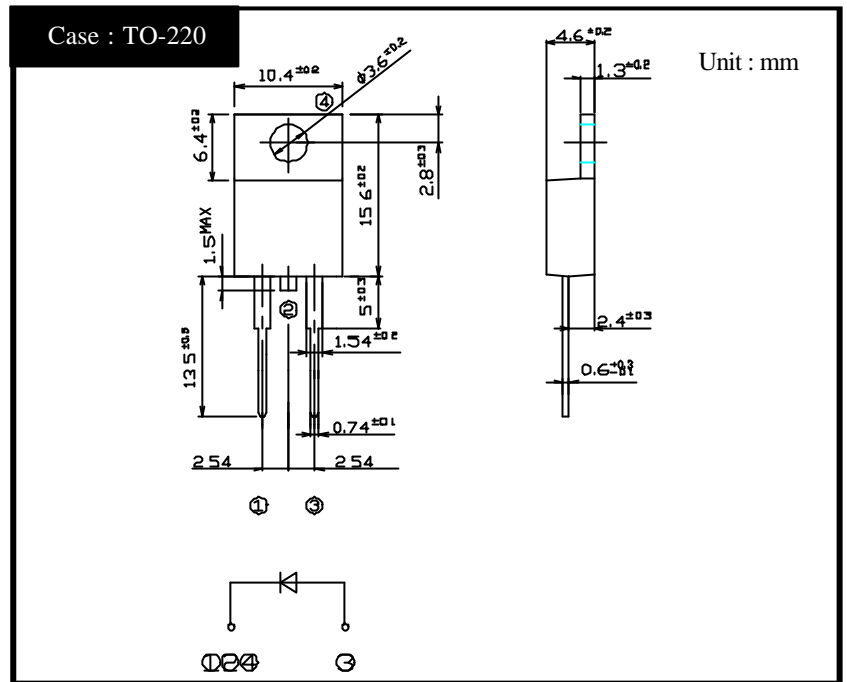

RATINGS

Absolute Maximum Ratings (If not specified Tc=25)

Item	Symbol	Conditions	Ratings	Unit
Storage Temperature	Tstg		-40 ~ 150	
Operating Junction Temperature	Tj		150	
Maximum Reverse Voltage	V _{RM}		40	V
Repetitive Peak Surge Reverse Voltage	V _{RRSM}	Pulse width 0.5ms, duty 1/40	45	V
Average Rectified Forward Current	I _O	50Hz sine wave, R-load Tc=138	5	A
Peak Surge Forward Current	I _{FSM}	50Hz sine wave, Non-repetitive 1 cycle peak value, Tj=125	100	A
Repetitive Peak Surge Reverse Power	P _{RRSM}	Pulse width 10 μ s, Tj=25	330	W
Mounting Torque	TOR	(Recommended torque :0.3N·m)	0.5	N·m

Electrical Characteristics (If not specified Tc=25)

Item	Symbol	Conditions	Ratings	Unit
Forward Voltage	V _F	I _F =5A, Pulse measurement	Max.0.55	V
Reverse Current	I _R	V _R =V _{RM} , Pulse measurement	Max.3.5	mA
Junction Capacitance	C _j	f=1MHz, V _R =10V	Typ.180	pF
Thermal Resistance	jc	junction to case	Max.3	/W

S5S4M

Forward Voltage

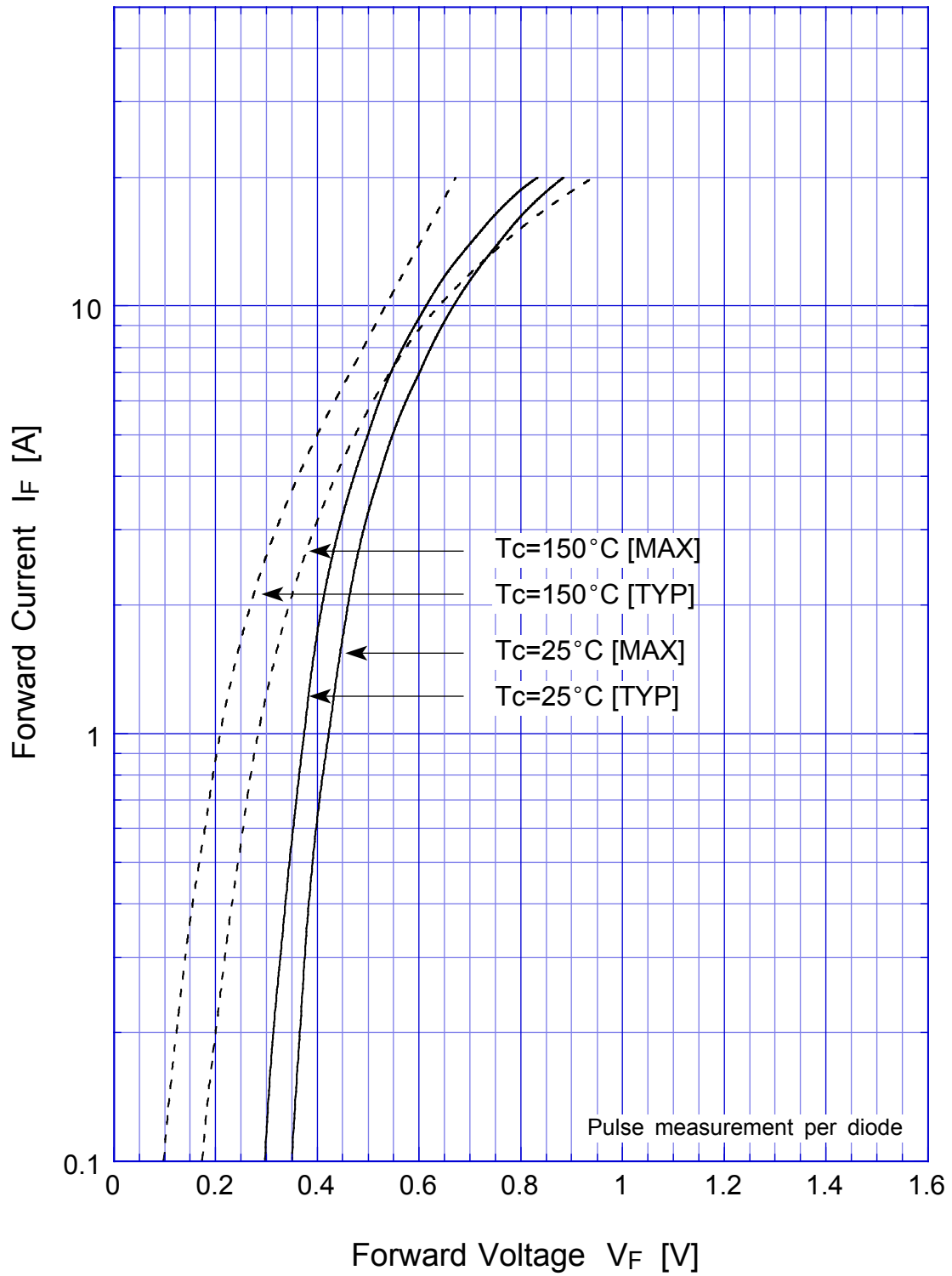

S5S4M

Junction Capacitance

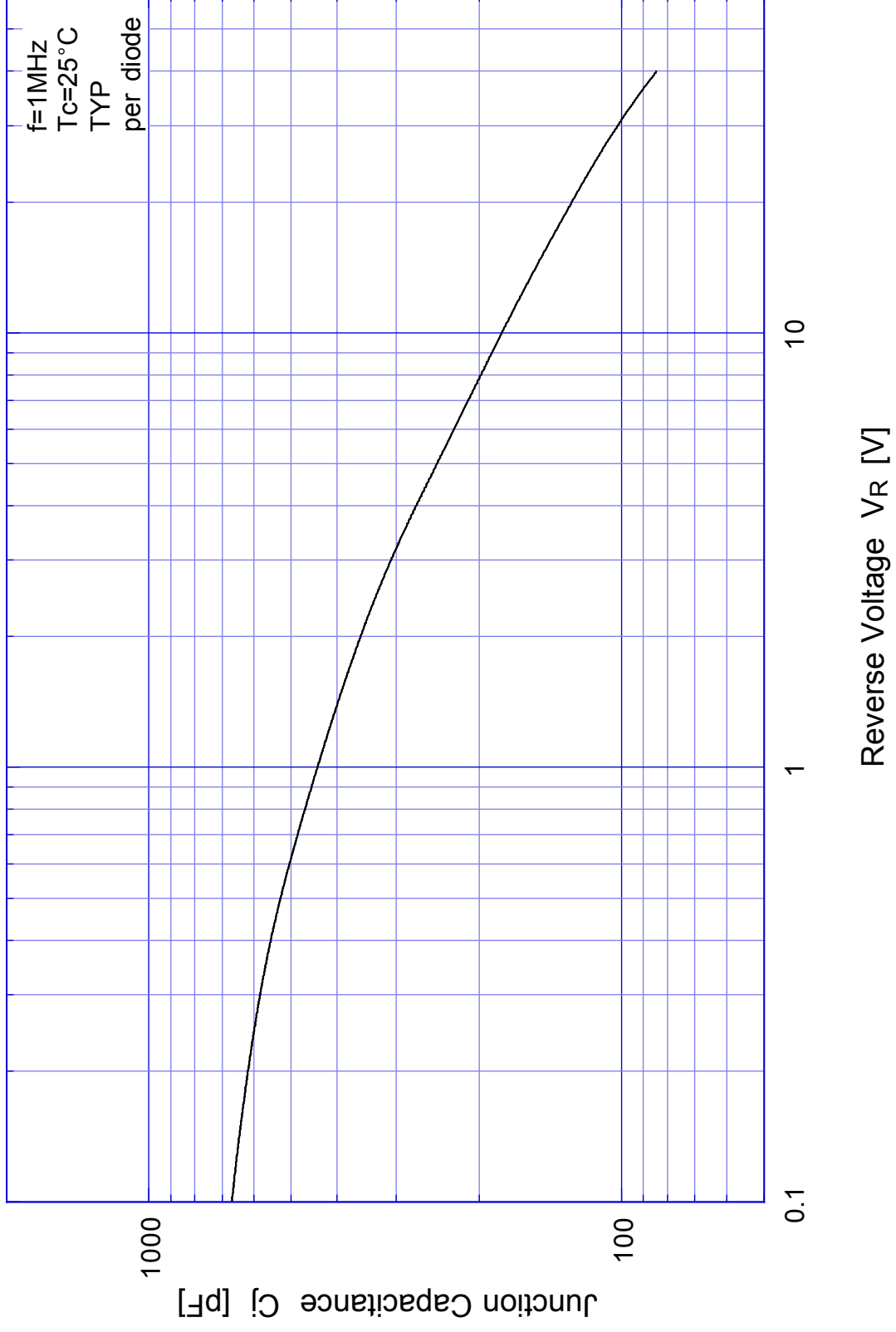

S5S4M

Reverse Current

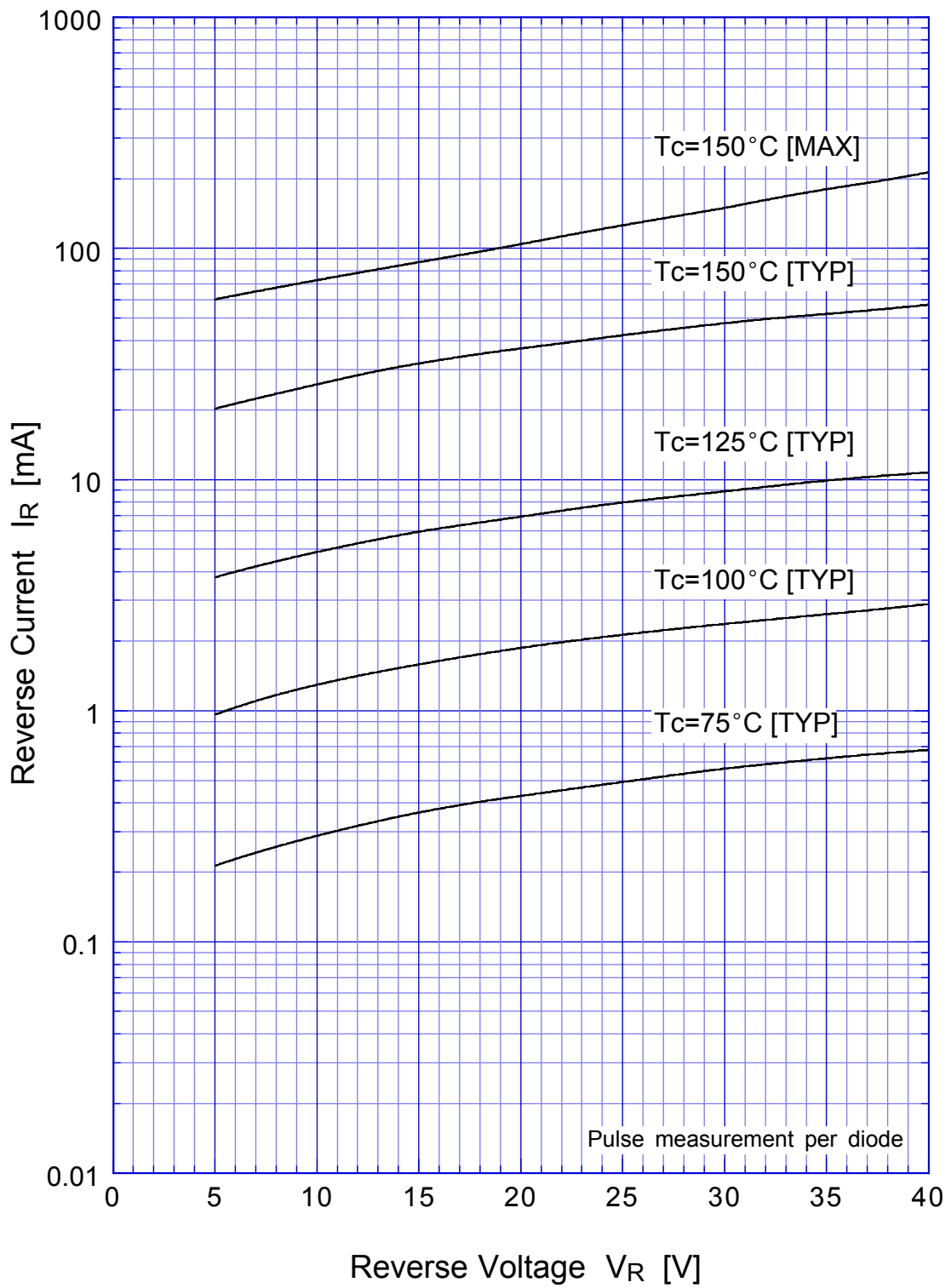

S5S4M

Reverse Power Dissipation

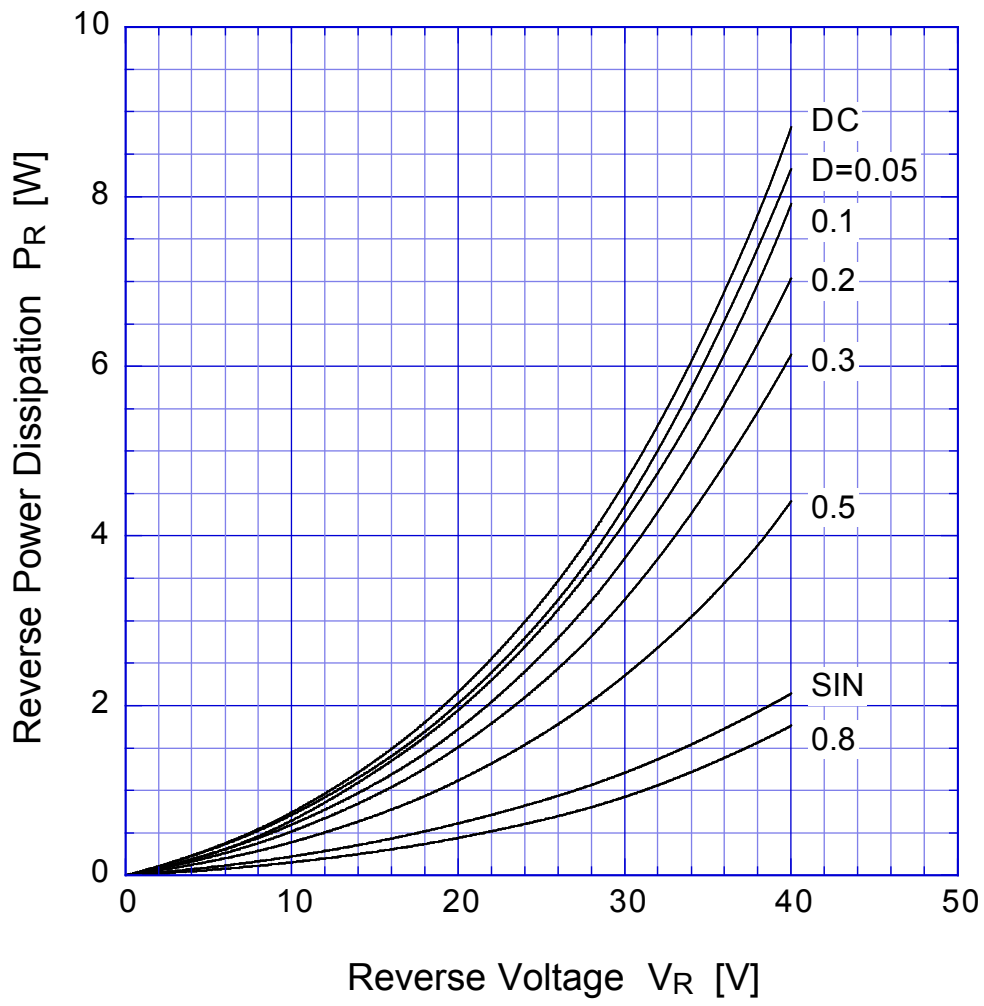

$T_j = 150^\circ\text{C}$

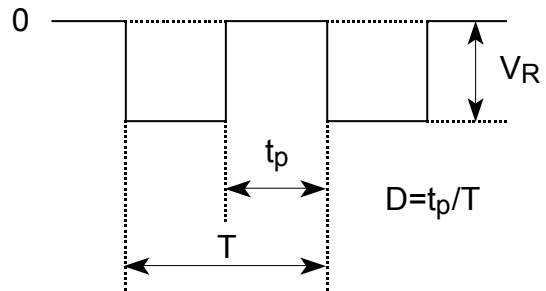

S5S4M

Forward Power Dissipation

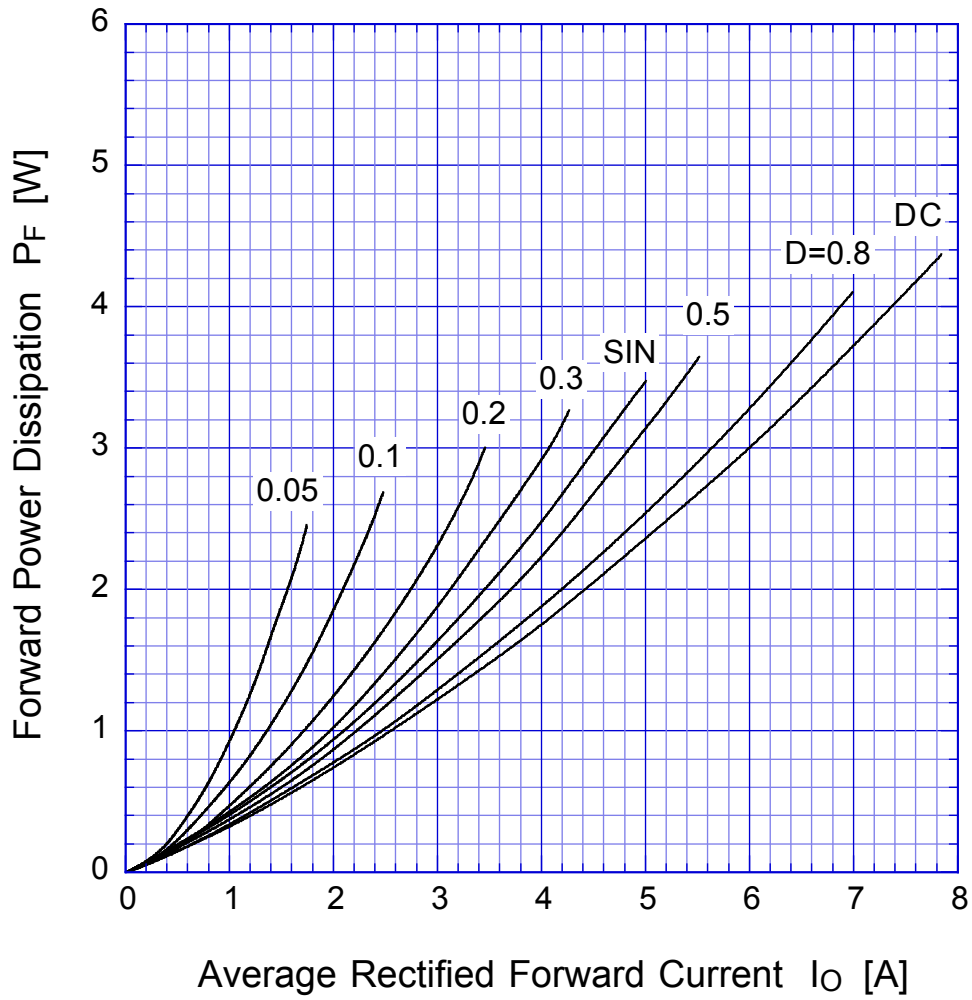

$T_j = 150^\circ\text{C}$

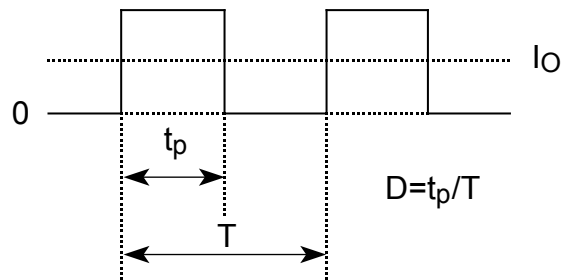

S5S4M

Derating Curve

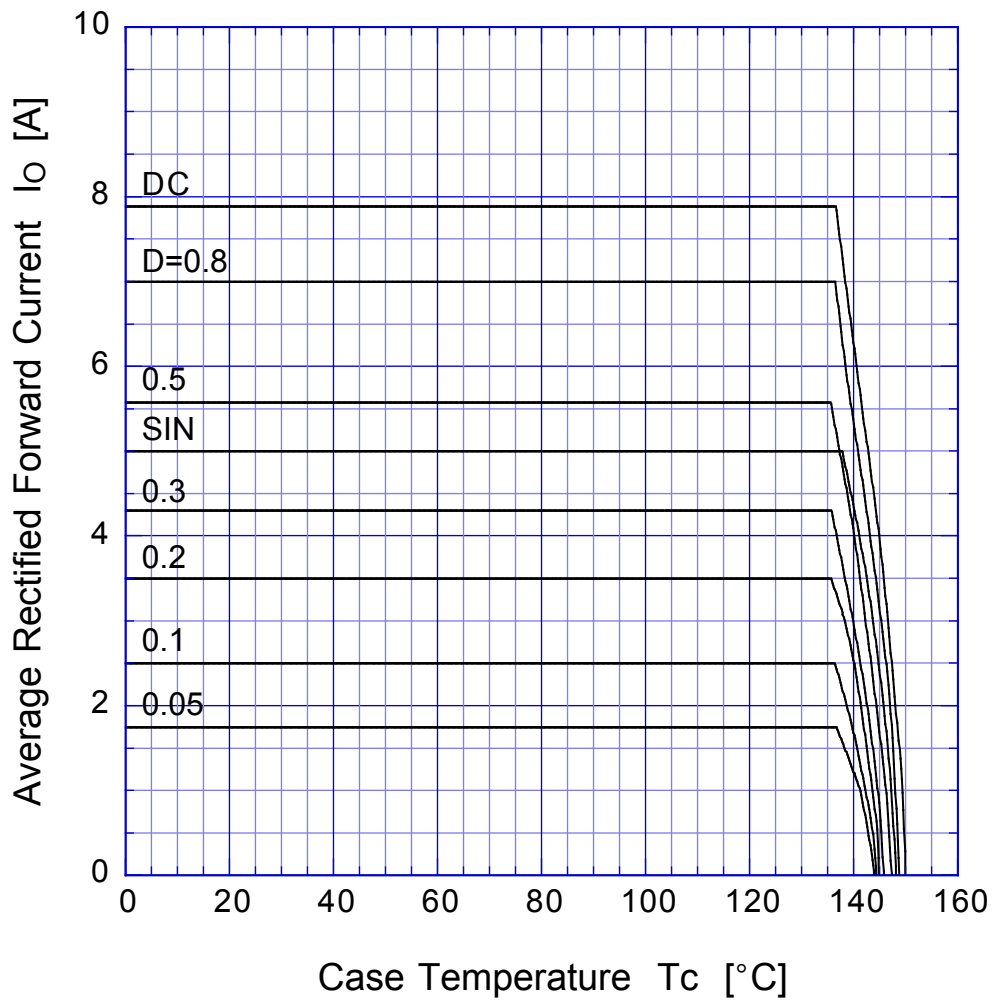

$V_R = 20V$

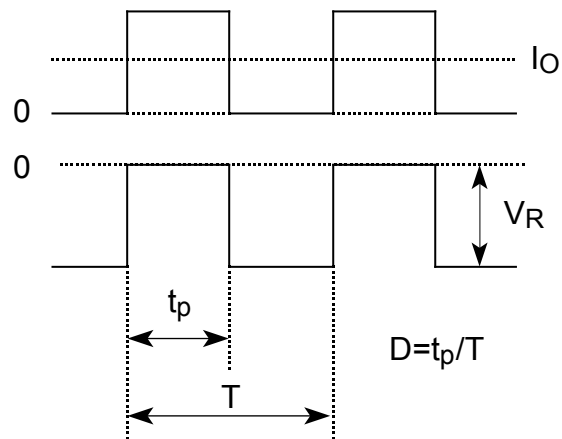

S5S4M

Peak Surge Forward Capability

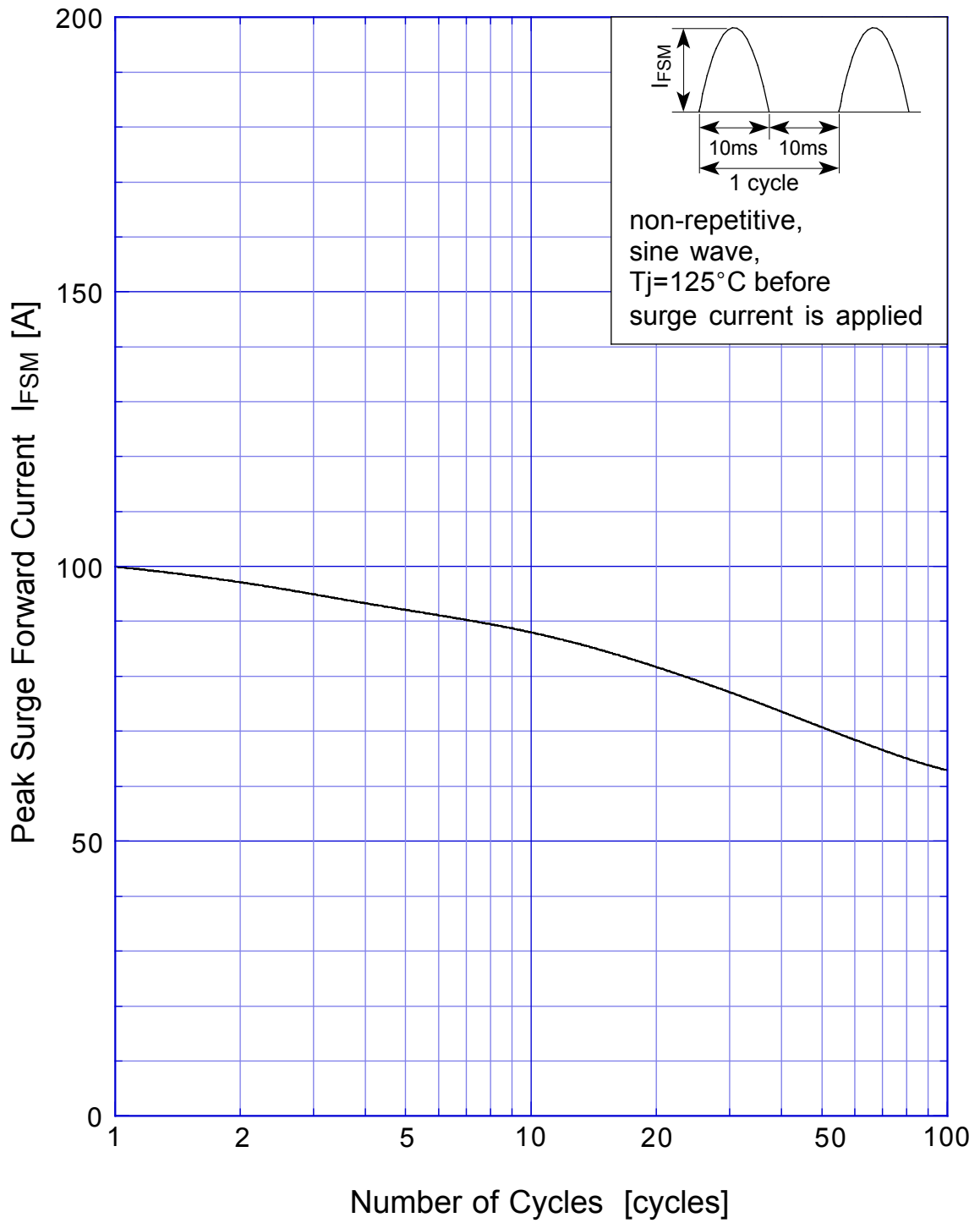

SBD Repetitive Surge Reverse Power Derating Curve



SBD

Repetitive Surge Reverse Power Capability

