



Silicon Passivated 3 Phase Bridge Rectifiers

Reverse Voltage - 50 to 1600Volts
Forward Current - 25 Amperes

Features

- Low forward voltage drop
- High current capability
- High reliability
- Meet UL flammability classification 94V-0

Mechanical Data

- Case: Epoxy case with heat sink
- Polarity: Symbol marked on body
- Mounting position:
- Bolt pass through the mounting hole of body then fix to heat sink
- Mounting torque: 2 N.m

Note: Products with logo  or  are made by HY Electronic (Cayman) Limited.

Applications

- For use in high power supply inverters, servo motor and welding machine applications

SBR

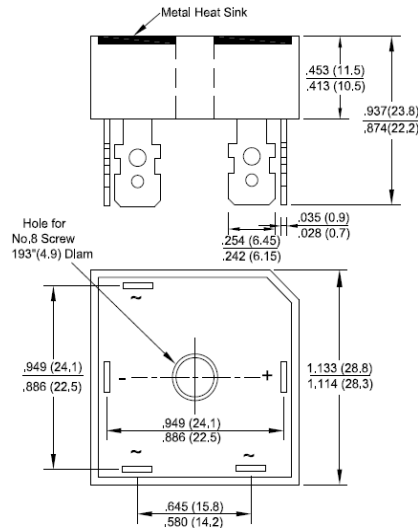

RoHS COMPLIANT

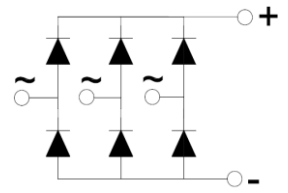

Package Outline Dimensions in Inches (Millimeters)

Maximum Ratings and Electrical Characteristics

Rating at 25°C ambient temperature unless otherwise specified.

Single phase, half wave, 60Hz, resistive or inductive load.
For capacitive load, derate current by 20%.

Characteristics	Symbol	SBR25										Unit
		-00	-01	-02	-04	-06	-08	-10	-12	-14	-16	
Maximum Repetitive Peak Reverse Voltage	V _{RRM}	50	100	200	400	600	800	1000	1200	1400	1600	V
Maximum RMS Voltage	V _{RMS}	35	70	140	280	420	560	700	840	980	1120	V
Maximum DC Blocking Voltage	V _{DC}	50	100	200	400	600	800	1000	1200	1400	1600	V
Peak Non-Repetitive Reverse Voltage	V _{RSM}	75	150	275	500	725	900	1100	1300	1500	1700	V
Maximum Average Forward Rectified Current @T _C =60 °C	I _(AV)	25										A
Peak Forward Surge Current, 8.3mS Single Half Sine-Wave, Superimposed on Rated Load (JEDEC Method)	I _{FSM}	375										A
I ² t Rating for Fusing (t<8.3mS)	I ² t	580										A ² S
Peak Forward Voltage per Diode at 12.5A DC	V _F	1.1										V
Maximum DC Reverse Current at Rated @T _J =25°C	I _R	10										µA
DC Blocking Voltage per Diode @T _J =125°C		5.0										mA
Typical Thermal Resistance Junction to Case per Diode	R _{θJC}	1.42										°C/W
Typical Thermal Resistance Case to Heatsink per Diode	R _{θCS}	0.2										°C/W
RMS Isolation Voltage from Case to Lead	V _{ISO}	2500										V
Operating Junction Temperature Range	T _J	-55 to +150										°C
Storage Temperature Range	T _{STG}	-55 to +150										°C

Note: The typical data above is for reference only



Fig. 1 - Current Rating Characteristics

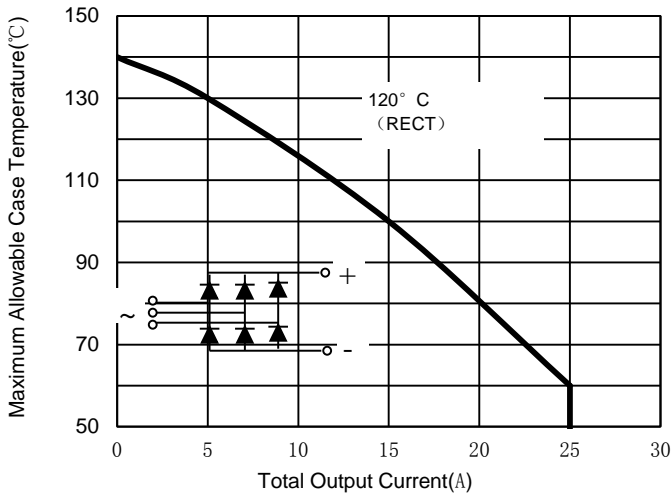

Fig. 2 - Typical Forward Characteristics

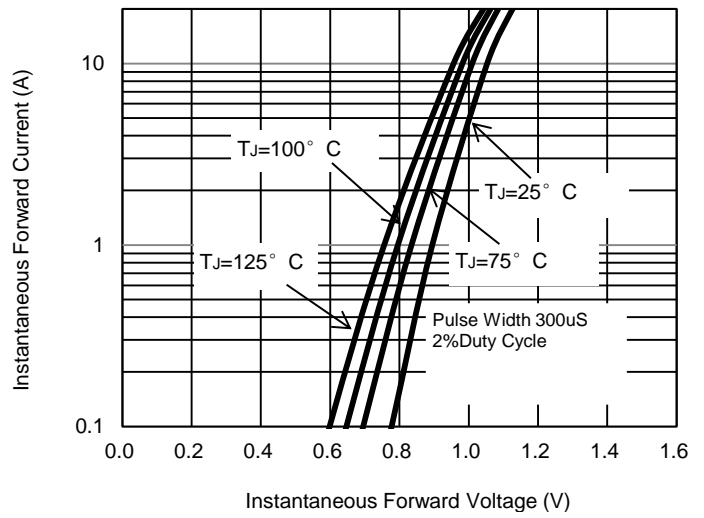

Fig. 3 - Total Power Loss Characteristics

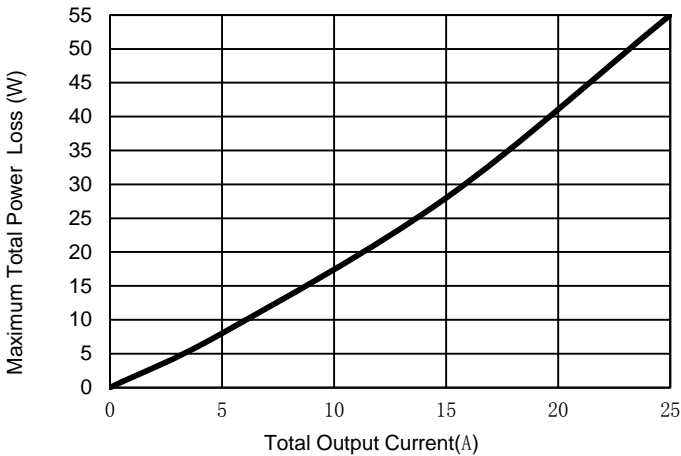

Fig. 4 - Total Power Loss Characteristics

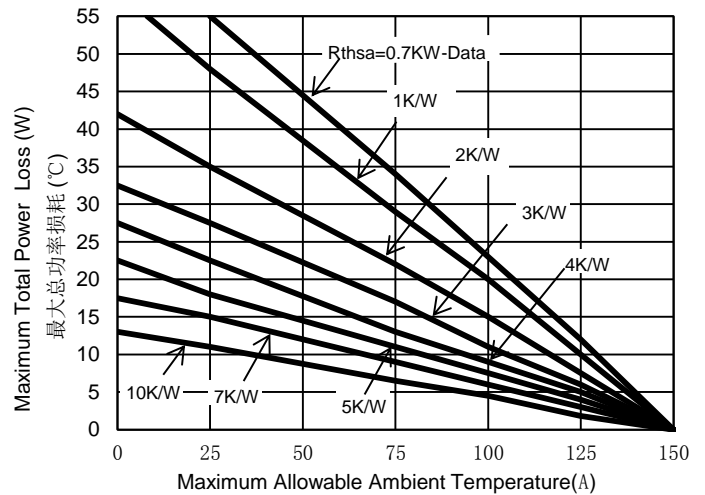

Fig. 5 - Maximum Non-repetitive Surge Current

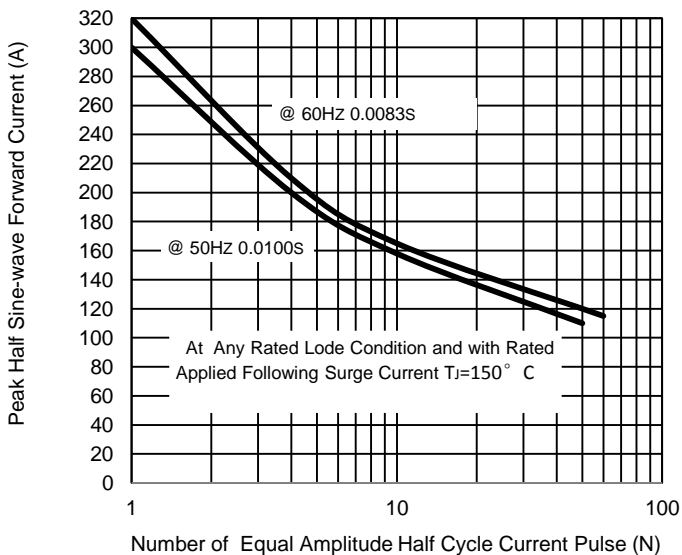
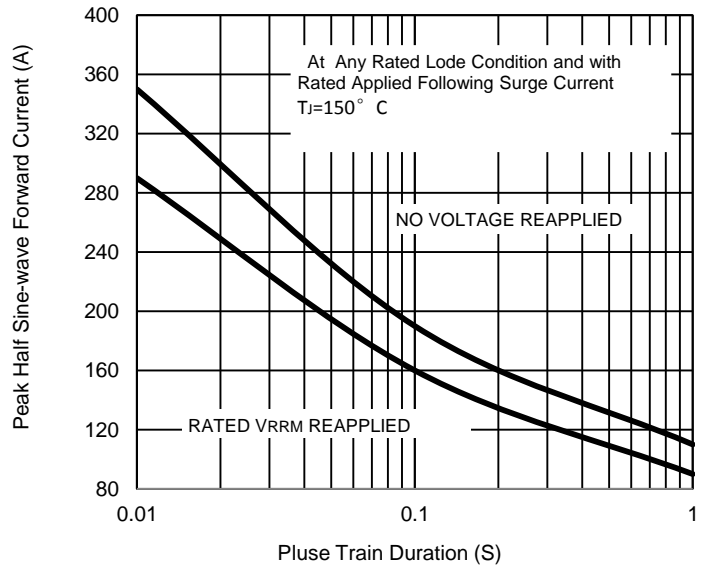

Fig. 6 - Maximum Non-repetitive Surge Current



The curve above is for reference only.



Fig. 7 - Thermal Impedance Z_{thjc} Characteristics

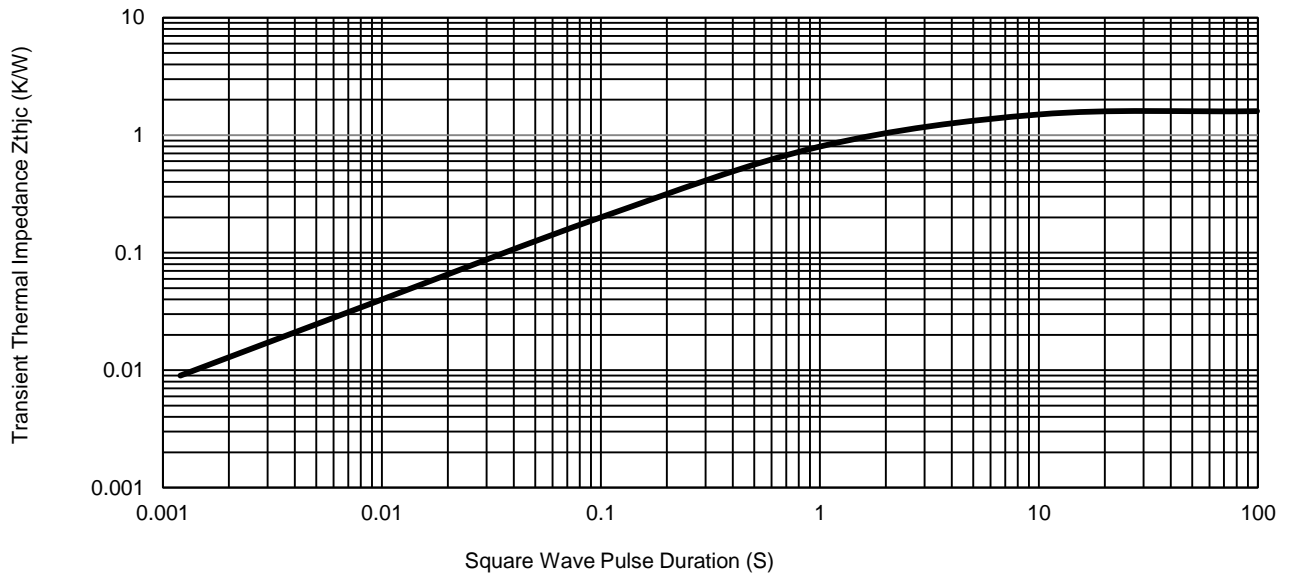

The curve above is for reference only.



Disclaimer

ALL specifications and data are subject to be changed without notice to improve reliability function or design or other reasons.

HY makes no warranty, representation or guarantee regarding the suitability of the products for any particular purpose or the continuing production of any product. To the maximum extent permitted by applicable law, HY disclaims (i) any and all liability arising out of the application or use of any product, (ii) any and all liability, including without limitation special, consequential or incidental damages, and (iii) any and all implied warranties, including warranties of fitness for particular purpose, non-infringement and merchantability.

Statements regarding the suitability of products for certain types of applications are based on HY's knowledge of typical requirements that are often placed on HY products in generic applications. Such statements are not binding statements about the suitability of products for a particular application. It is the customer's responsibility to validate that a particular product with the properties described in the product specification is suitable for use in a particular application. Parameters provided in datasheets and specifications may vary in different applications and performance may vary over time. All operating parameters, including typical parameters, must be validated for each customer application by the customer's technical experts. Product specifications do not expand or otherwise modify HY's terms and conditions of purchase, including but not limited to the warranty expressed therein.

Except as expressly indicated in writing, HY products are not designed for use in medical, life-saving, or life-sustaining applications or for any other applications in which the failure of the HY product could result in personal injury or death. Customers using or selling HY products not expressly indicated for use in such applications do so at their own risk. Please contact authorized HY personnel to obtain written terms and conditions regarding products designed for such applications.

No license, express or implied, by estoppel or otherwise, to any intellectual property rights is granted by this document or by any conduct of HY. Product names and markings noted herein may be trademarks of their respective owners.