

1. Synopsis

1-1. General Description

This TBR03L045 Series are Trench MOS Barrier Schottky Rectifier (TBR) Provides Fast Switching Performance in a Compact Thermally Efficient Package. Its Low Profile Makes it a Good Option For Flat Panel Display and Other Applications With Limited Vertical Clearance. The Device Offers Low Leakage Over Temperature Making it a Good Match For Applications Requiring Low Quiescent Current.

1-2. Feature List

- Trench MOS Barrier Schottky Technology
- Low Forward Voltage Drop
- 45-Volts Reverse
- High Frequency Operation

1-3. Applications

- Switch Mode Power Supply
- Power Factor Correction
- Solar Inverter
- Uninterruptible Power Supply
- High Efficiency DC/DC Converters
- Motor Drivers

1-4. Benefits

- Essentially No Switching Losses
- Higher Efficiency
- Reduction Of Heat Sink Requirements
- Parallel Devices Without Thermal Runaway
- Higher System Reliability Due To Lower Operating Temperatures

1-5. Mechanical Characteristics

- Molded JEDEC Package:
 - SMAJ
 - SMAF
 - SMBJ
 - SMBF
- Packing: Tape and Reel
- Flammability rating UL 94V-0
- Halogen Free
- JEDEC MSL Classification: Level 1



SMAJ

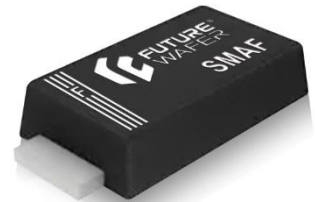

SMAF

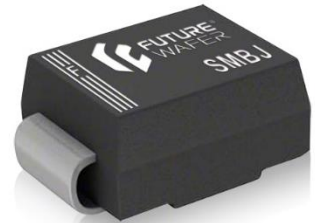

SMBJ

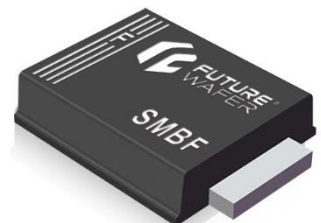

SMBF

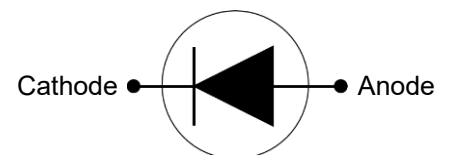

2. Contents

1. Synopsis	1
1-1. General Description	1
1-2. Feature List	1
1-3. Applications	1
1-4. Benefits	1
1-5. Mechanical Characteristics	1
2. Contents	2
3. Electrical Property	3
3-1. Absolute Maximum Ratings	3
3-2. Electrical Characteristics	3
3-3. Thermal Characteristics	3
3-4. Ratings and Characteristics Curve	4
4. Soldering Parameters	5
5. Package Information	6
5-1. Dimension-SMAJ	6
5-2. PCB Pad Layout Recommendation-SMAJ	6
5-3. Dimension-SMAF	7
5-4. PCB Pad Layout Recommendation-SMAF	7
5-5. Dimension-SMBJ	8
5-6. PCB Pad Layout Recommendation-SMBJ	8
5-7. Dimension-SMBF	9
5-8. PCB Pad Layout Recommendation-SMBF	9
6. Packing	10
6-1. Taping and Reel Specification-SMAJ & SMAF	10
6-2. Embossed Carrier Tape Specification-SMAJ & SMAF	10
6-3. Taping and Reel Specification-SMBJ & SMBF	11
6-4. Embossed Carrier Tape Specification-SMBJ & SMBF	11
6-5. Surface Mount Reel Specification	12
6-6. Tape Leader and Trailer Specification	12
7. Ordering Information	13
8. Version	13
8-1. History	13
8-2. Company Profile	13

3. Electrical Property

3-1. Absolute Maximum Ratings

Maximum Ratings@25°C Unless Otherwise Specified			
Parameter	Symbol	Values	Units
Peak Repetitive Reverse Voltage	V_{RRM}	45	V
Maximum RMS Voltage	V_{RMS}	31	
Average Rectified Output Current	I_O	3	A
Peak Forward Surge Current, 8.3ms Signal Half Sine Wave Unidirectional Only(1)	I_{FSM}	80	

Notes: (1) Measured on 8.3ms signal half sine wave or equivalent square wave, duty cycle=4 per minute maximum.

3-2. Electrical Characteristics

Parameter	Symbol	Condition	Min.	Typ.	Max.	Units	
Forward Voltage Drop	V_F	$I_F = 1.5A$	$T_J = 25^\circ C$	-	0.41	-	V
		$I_F = 3A$		-	0.46	0.54	
		$I_F = 1.5A$	$T_J = 125^\circ C$	-	0.31	-	
		$I_F = 3A$		-	0.37	0.46	
Reverse Current	I_R	$V_R = 45V$	$T_J = 25^\circ C$	-	10	20	uA
			$T_J = 125^\circ C$	-	5	25	mA
ESD Standards	V_{ESD}	IEC61000-4-2, Contact	-	-	8	KV	

3-3. Thermal Characteristics

Parameter	Symbol	Min.	Typ.	Max.	Units
Thermal Resistance, Junction-Ambient	$R_{\theta JA}$	-	115	-	°C/W
Thermal Resistance, Junction-Case	$R_{\theta JC}$	-	12.0	-	
Operating Temperature	T_J	-55 ~ +150			°C
Storage Temperature	T_{STG}				

3-4. Ratings and Characteristics Curve

Fig 1. Maximum Forward Current Derating Curve

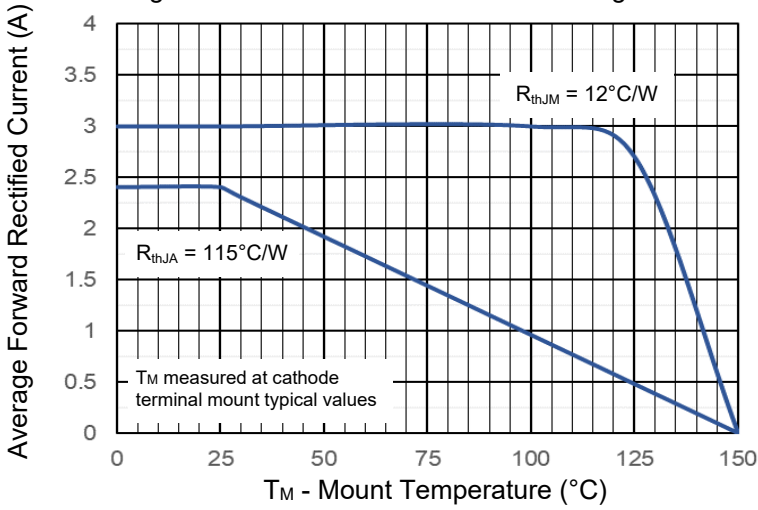

Fig 2. Typical Instantaneous Forward Characteristics

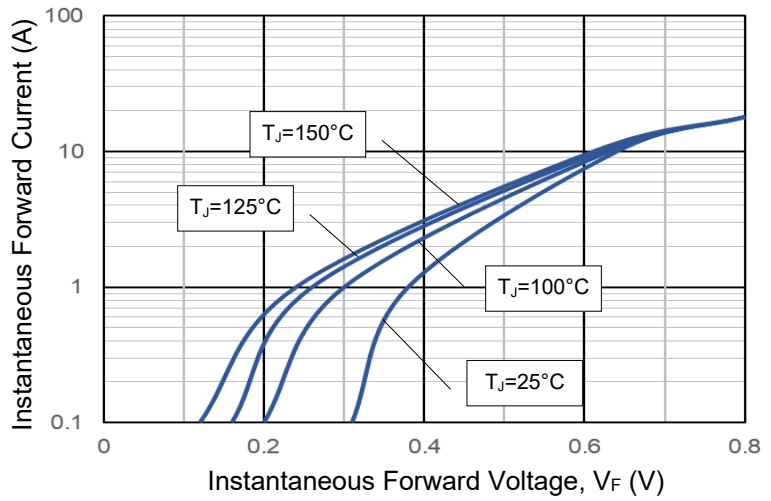

Fig 3. Typical Reverse Current Characteristics

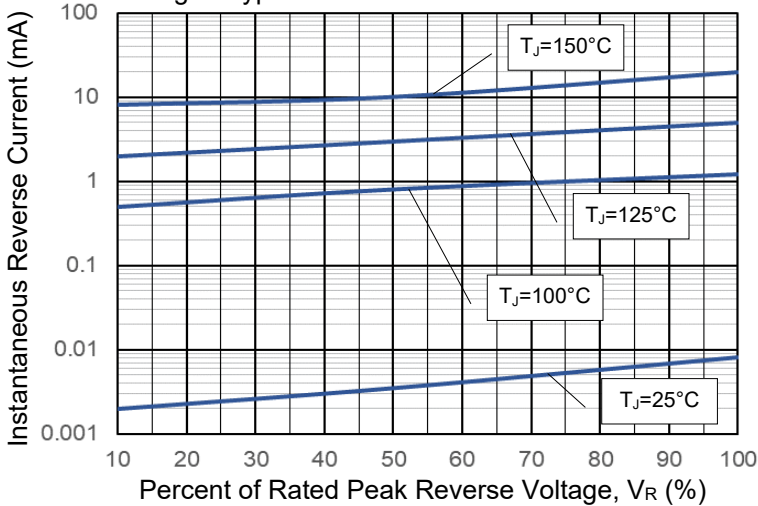

Fig 4. Typical Junction Capacitance

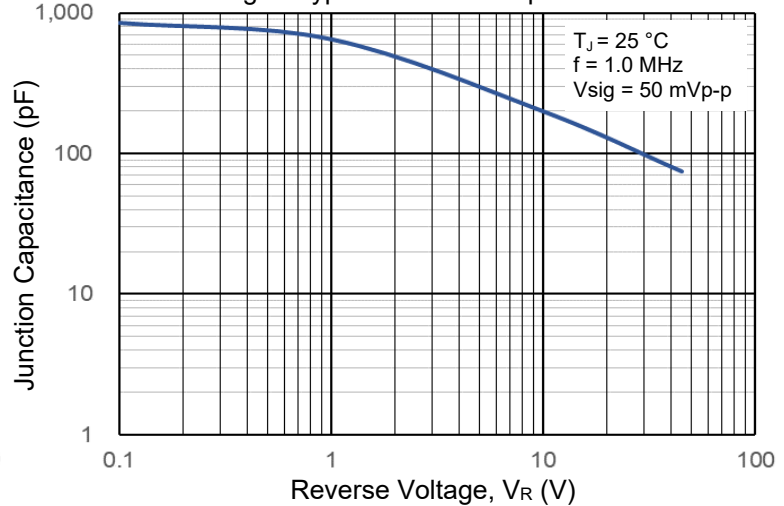

Fig 5. Forward Power Loss Characteristics

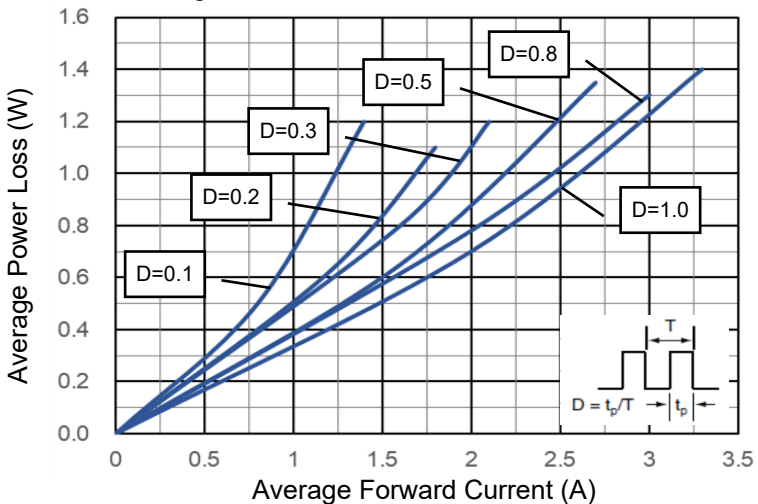
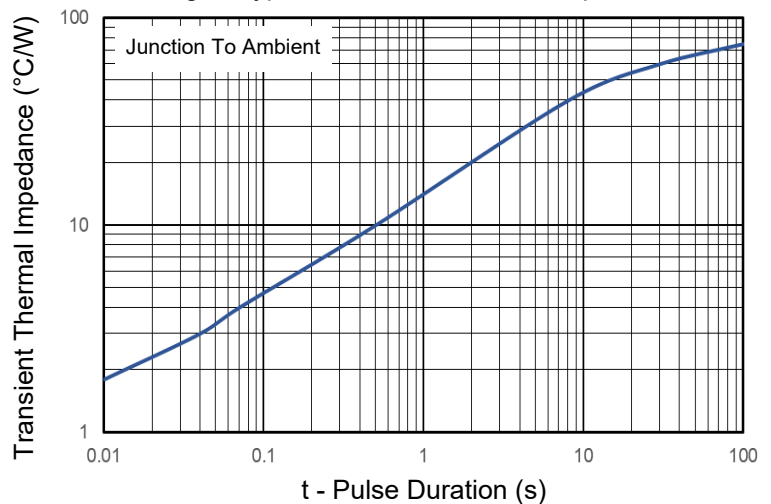

Fig 6. Typical Transient Thermal Impedance



4. Soldering Parameters

Profile Feature	SnPb eutectic assembly	Pb-free assembly
Average ramp-up rate (T _{smax} to T _p)	3 °C/s maximum	3 °C/s maximum
Preheat		
Temperature minimum (T _{smin})	100 °C	150 °C
Temperature maximum (T _{smax})	150 °C	200 °C
Time (t _{smin} to t _{smax})	60 s to 120 s	60 s to 180 s
Time maintained above		
Temperature (T _L)	183 °C	217 °C
Time (t _L)	60 s to 150 s	60 s to 150 s
Peak/classification temperature (T)	235 °C	260 °C
Number of allowed reflow cycles	3	3
Time within 5 °C of actual peak temperature (t _p)	10 s to 30 s	20 s to 40 s
Ramp-down rate	6 °C/s maximum	6 °C/s maximum
Time 25 °C to peak temperature	6 minutes maximum	8 minutes maximum

temperature

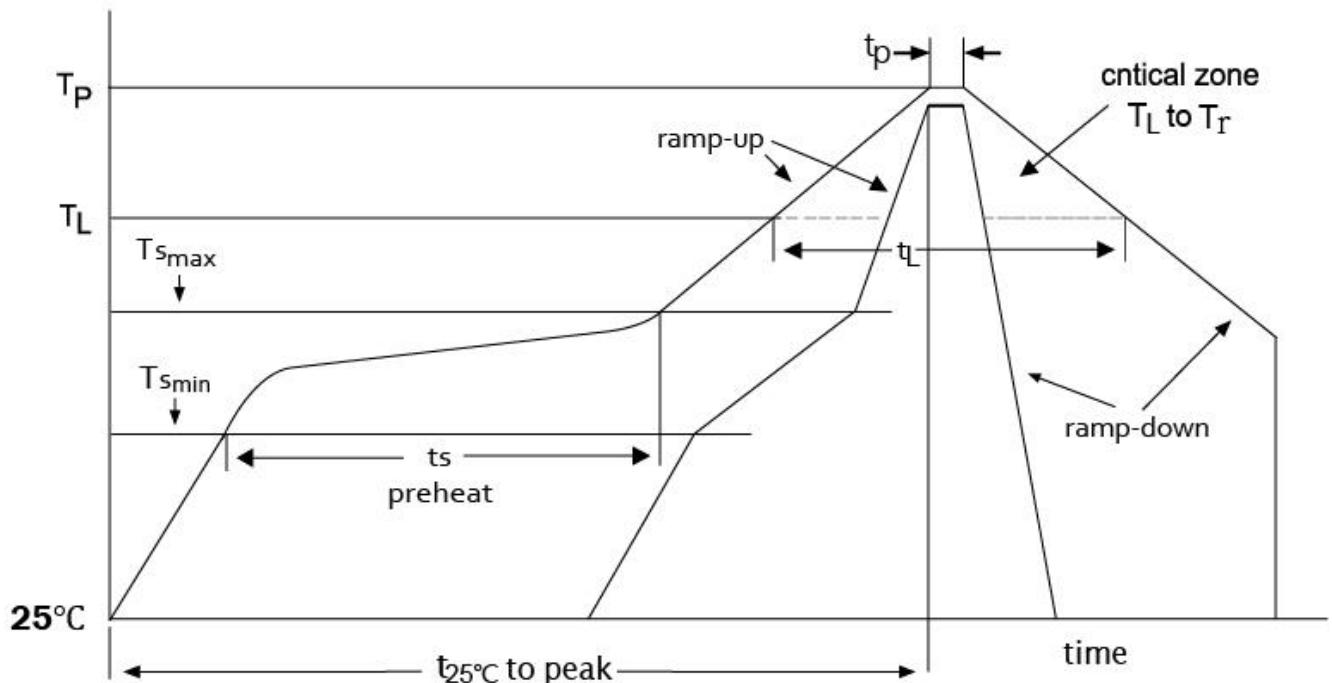

5. Package Information

5-1. Dimension-SMAJ

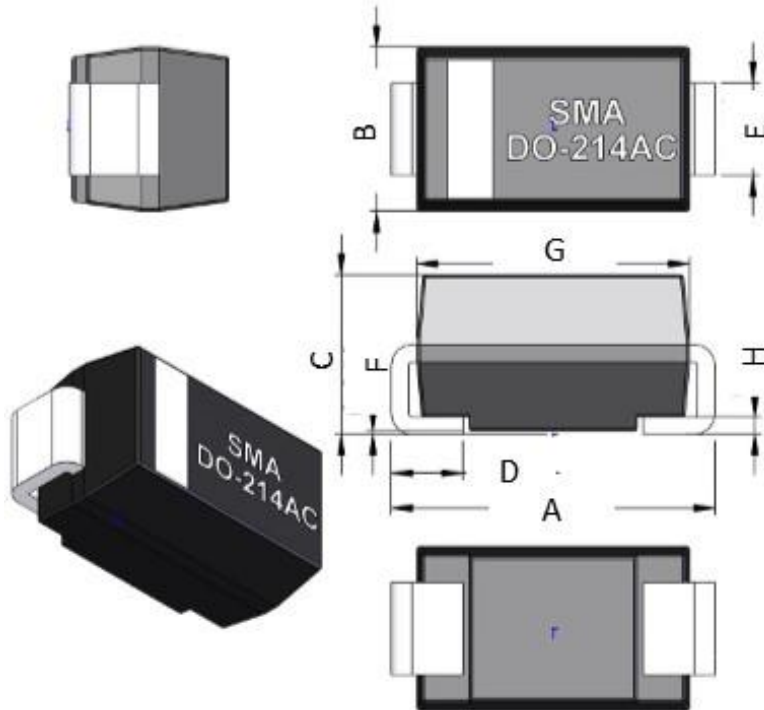

SMAJ		
Symbol	Min.	Max.
A	4.75	5.25
B	2.55	2.85
C	2.00	2.50
D	0.85	1.55
E	1.35	1.65
F	-	0.40
G	4.25	4.55
H	0.15	0.30

Unit:mm

5-2. PCB Pad Layout Recommendation-SMAJ

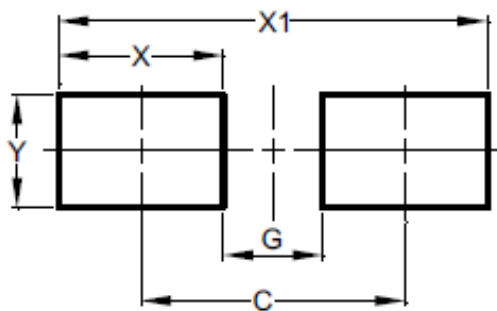

SMAJ	
Symbol	Values
C	4.00
G	1.50
X	2.50
X1	6.50
Y	1.70

Unit:mm

5-3. Dimension-SMAF

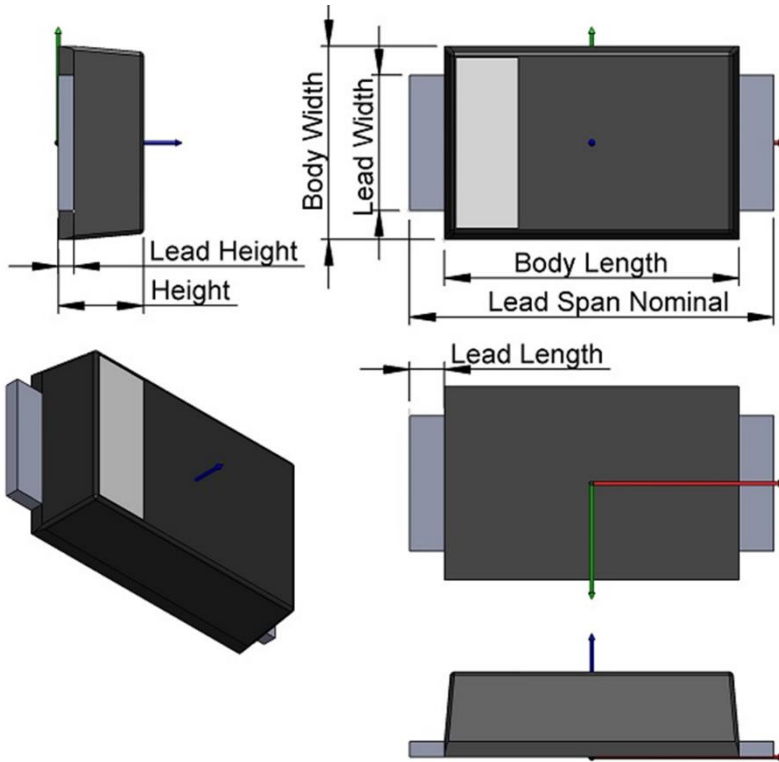

SMAF		
Symbol	Min.	Max.
Body Length	4.15	4.35
Lead Span Nominal	5.05	5.35
Lead Width	1.25	1.45
Body Width	2.50	2.70
Height	0.90	1.30
Lead Height	0.15	0.30
Lead Length	0.70	1.00

Unit:mm

5-4. PCB Pad Layout Recommendation-SMAF

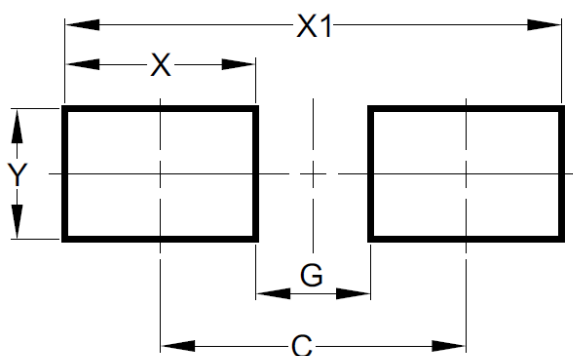

SMAF	
Symbol	Values
C	4.32
G	3.12
X	1.20
X1	5.52
Y	1.52

Unit:mm

5-5. Dimension-SMBJ

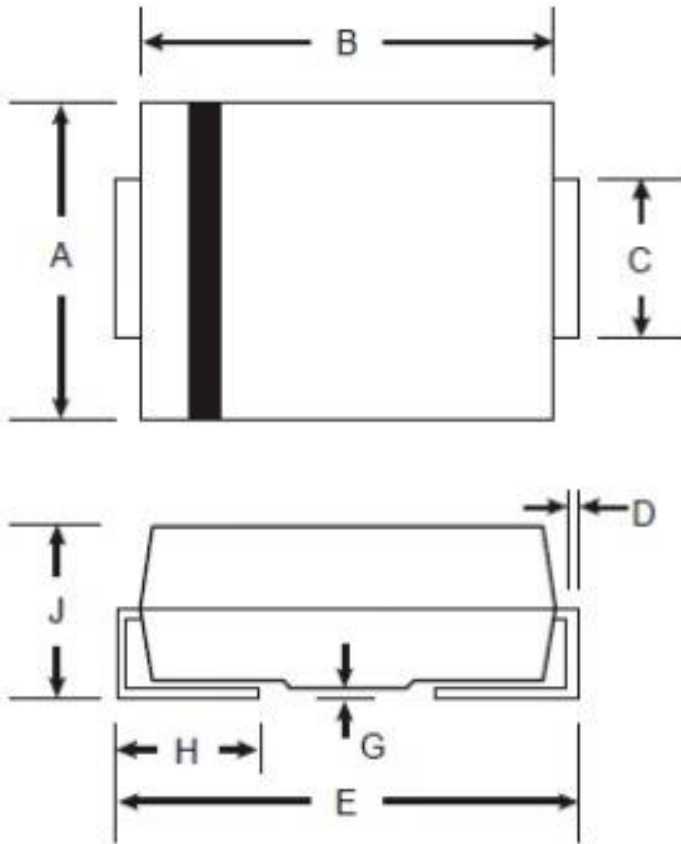

SMBJ		
Symbol	Min.	Max.
A	3.30	3.94
B	4.06	4.57
C	1.96	2.21
D	0.15	0.31
E	4.80	5.59
G	0.05	0.20
H	0.76	1.52
J	1.98	2.50

Unit:mm

5-6. PCB Pad Layout Recommendation-SMBJ

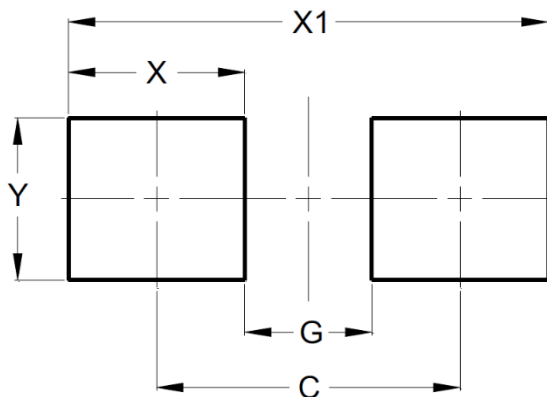

SMBJ	
Symbol	Values
C	4.30
G	1.80
X	2.50
X1	6.80
Y	2.30

Unit:mm

5-7. Dimension-SMBF



SMBF			
Symbol	Min.	Typ.	Max.
Body Length	-	4.4	-
Lead Span Nominal	5.2	-	5.6
Lead Width	1.9	-	2.1
Body Width	3.1	-	3.7
Height	1.1	-	1.7
Lead Height	-	0.2	-
Lead Length	-	0.02	-

Unit:mm

5-8. PCB Pad Layout Recommendation-SMBF

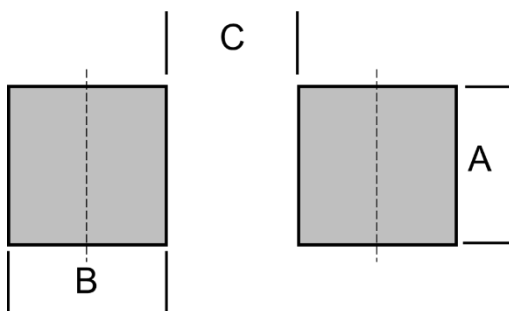

SMBF	
Symbol	Values
C	3.10
A	2.20
B	2.10

Unit:mm

6. Packing

6-1. Taping and Reel Specification-SMAJ & SMAF

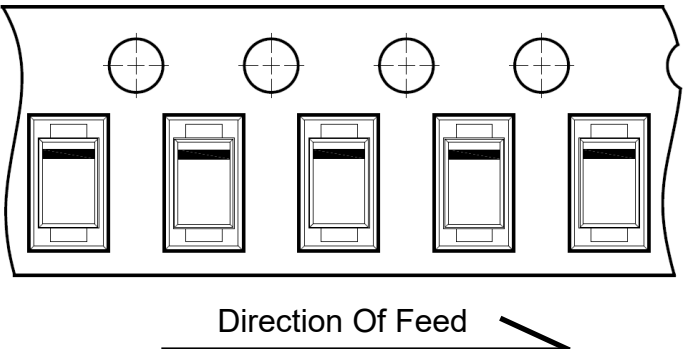
Taping Width	Tape Orientation
12mm	

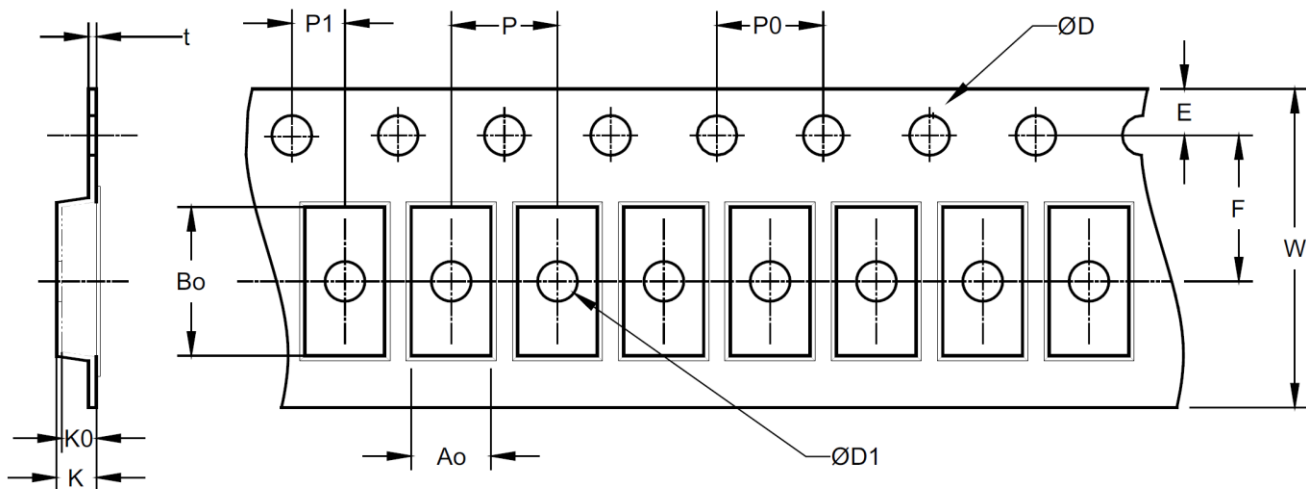

6-2. Embossed Carrier Tape Specification-SMAJ & SMAF



Unit:mm

Dimension	W	Ao	Bo	D	D1	E	F	K	P	P0	P1	t	W
Value	12 mm	3.0 ±0.10	5.6 ±0.10	1.5 ±0.10	1.5 Min	1.75 ±0.10	5.5 ±0.05	1.2 ±0.10	4.0 ±0.10	4.0 ±0.05	2.0 ±0.05	0.25 ±0.05	12 ±0.2
A0 / B0 / K0	Determined by Component Size. The Clearance Between the Component And The Cavity Must Comply to The Rotational And Lateral Movement Requirement Provided in Figures in The "Maximum Component Movement in Tape Pocket" Section.												

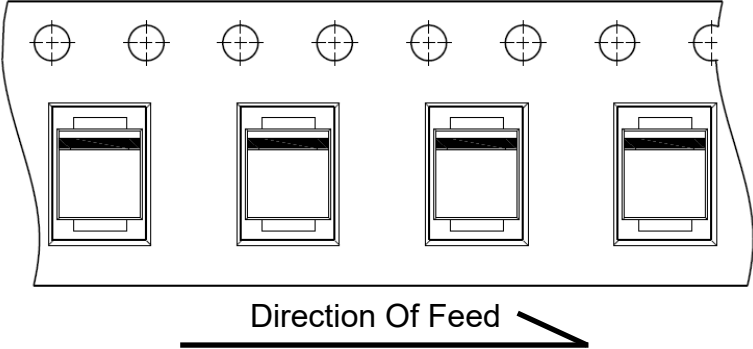
6-3. Taping and Reel Specification-SMBJ & SMBF

Taping Width	Tape Orientation
12mm	 <p style="text-align: center;">Direction Of Feed </p>

6-4. Embossed Carrier Tape Specification-SMBJ & SMBF

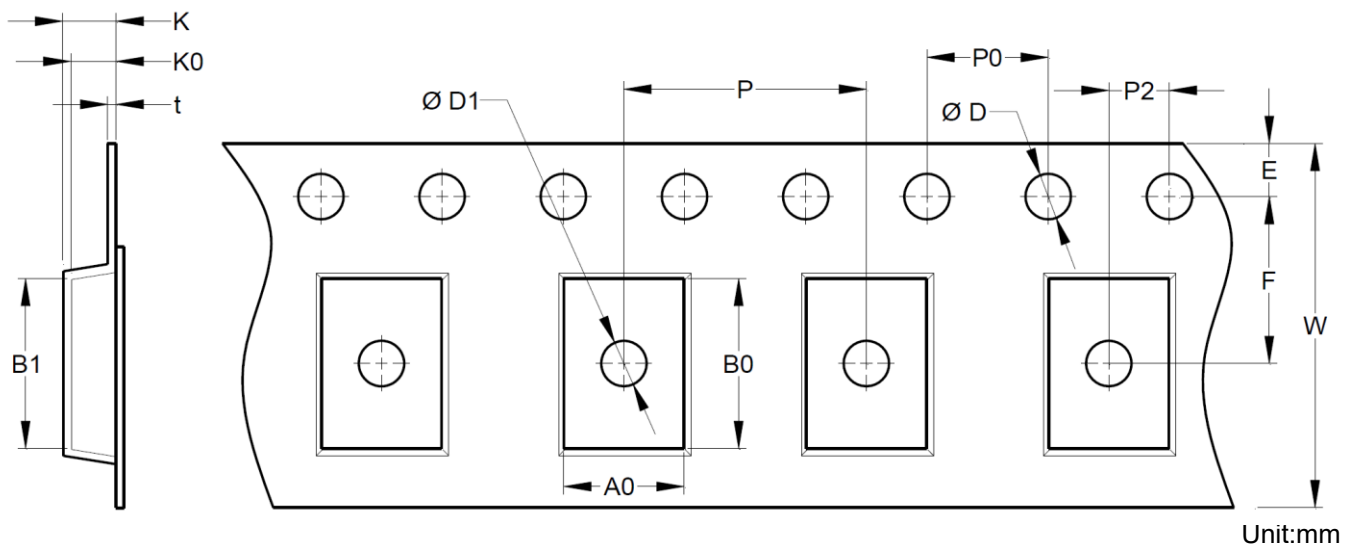

Unit:mm

Dimension	W	B1	D	D1	E	F	K	P	P0	P2	t	W
Value	12 mm	8.2 Max	1.5+ 0.1/- 0.0	1.5 Min.	1.75 ±0.10	5.5 ±0.05	4.5 Max.	8.0 ±0.10	4.0 ±0.10	2.0 ±0.05	0.4 Max.	12 ±0.3
A0 / B0 / K0	Determined by Component Size. The Clearance Between the Component And The Cavity Must Comply to The Rotational And Lateral Movement Requirement Provided in Figures in The "Maximum Component Movement in Tape Pocket" Section.											

6-5. Surface Mount Reel Specification

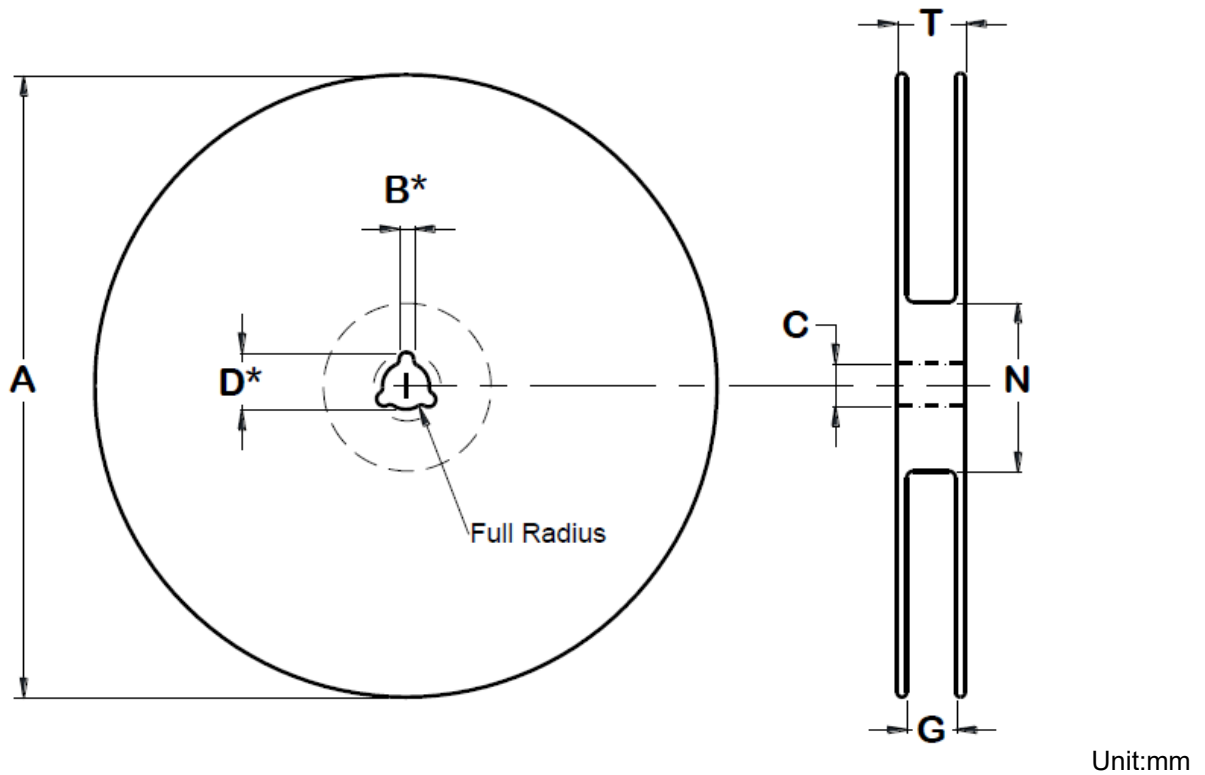

Unit:mm

Dimension	Tape Width	Reel Size	A	B	C	D	N	G	T
Value	12 mm	13"	330 ±2	2.0 +0.5-0	13 +0.5-0.2	20.5 ±0.2	100 ±2	12.4 +2.0 -0.0	18.4

6-6. Tape Leader and Trailer Specification

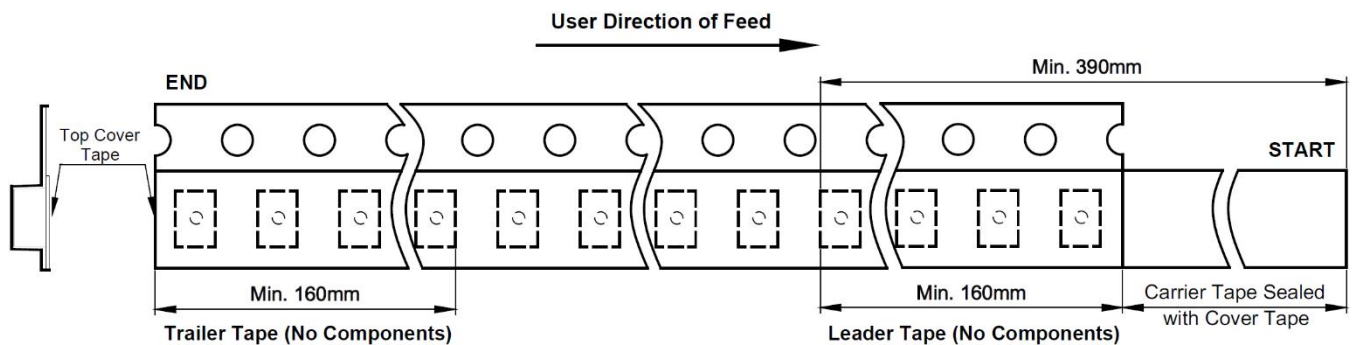

7. Ordering Information

Part Number	Marking Code	Quantity	Component Package	Packaging Option
TBR03L045A	F34J	5,000PCS	SMAJ	Tape & Reel - 12mm tape / 13" reel
TBR03L045AF	F34F		SMAF	
TBR03L045B	F34B	3,000PCS	SMBJ	
TBR03L045BF	F3VB		SMBF	

8. Version

8-1. History

Version	Date	File No.	Recording	Basis
A	06-Sep-2020	F22037R	New Create	Market
2.0	20-Feb-2021		Update Version	System
2.1	05-Oct-2021		Update Version	System