

Han PE-module male crimp 35qmm

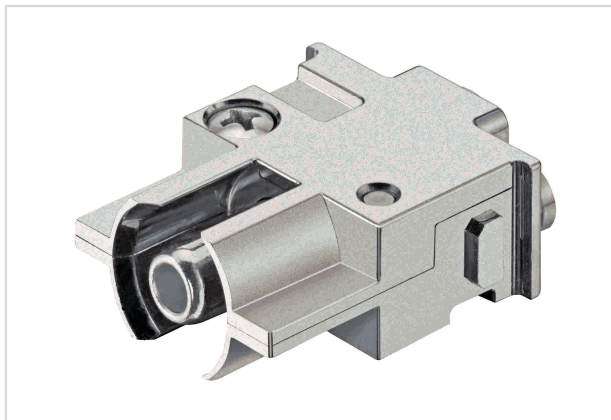

Image is for illustration purposes only. Please refer to product description.

Part number	09 14 001 3074
Specification	Han PE-module male crimp 35qmm
HARTING eCatalogue	https://b2b.harting.com/09140013074

Identification

Category	Modules
Series	Han-Modular®
Type of module	Han® PE module

Version

Termination method	Crimp termination
Gender	Male
Number of contacts	1
Pack contents	2 PE module halves 1 contact pressure plate 1 crimp contact

Technical characteristics

Conductor cross-section	35 mm ²
Contact resistance	≤0.3 mΩ
Stripping length	16 mm
Tightening torque	2 Nm
Limiting temperature	-40 ... +125 °C
Mating cycles	≥500

Material properties

Material (insert)	Zinc die-cast, nickel-plated
Material (contacts)	Copper alloy
Surface (contacts)	Silver plated



Pushing Performance

Material properties

RoHS	compliant with exemption
RoHS exemptions	6(c): Copper alloy containing up to 4 % lead by weight
ELV status	compliant with exemption
China RoHS	50
REACH Annex XVII substances	No
REACH ANNEX XIV substances	No
REACH SVHC substances	Yes
REACH SVHC substances	Lead
ECHA SCIP number	5dbb3851-b94e-4e88-97a1-571845975242

Specifications and approvals

Specifications	IEC 61984
UL / CSA	UL 1977 ECBT2.E235076 CSA-C22.2 No. 182.3 ECBT8.E235076

Commercial data

Packaging size	1
Net weight	85.9 g
Country of origin	Germany
European customs tariff number	85366990
eCl@ss	27440217 Module for industrial connectors (power/signals)