

Analogue Signal Processing

The problem

The real world can be measured in many ways, for example, via temperature, humidity, air pressure and so forth. The parameters of these different physical qualities change continuously. Elements that monitor statuses and changes in statuses of a given environment, must reflect these continual changes. Within the framework of industrial monitoring tasks, the statuses of an environment are monitored by using sensors. These sensors should provide signals that enable connected evaluating and monitoring installations to draw detailed conclusions concerning the status of, for example, a production process. The sensor signals trace the continuous changes in the monitored range. The signals can be in analogue or digital form; which means in normal cases, an electrical voltage or current value is produced that corresponds proportionally to the monitored physical quantities. Increasing automation with the intention of achieving or maintaining certain predetermined statuses makes the processing of analogue values increasingly important. This is also true of fields beyond those where this has been necessary and standard for a long time, for example, processing technology in the chemical industry. Standard electrical signal values are the norm within the framework of this processing technology. Current values from 0...20 mA, 4...20 mA or voltage values from 0...10 V have been introduced as sensor output values for differing physical quantities. Weidmüller has taken account the need for increasing automation with the processing of these analogue signals, and offers a wide range of products that are designed for handling sensor signals. This means, units are made available for standard signals (0...20 mA, 4...20 mA, 0...10 V) that generate output signal values proportional to the variable input signals, and at the same time enable the safe separation of, for example, sensor circuits of an evaluation circuit. This safe separation is

particularly important to avoid mutual interference of multiple sensor circuits, for example, ground loops in interlinked measurement circuits. The wide range of products includes all functions for converting separation and monitoring signals. The different designs in connection with the respective functions cover practically all applications in industrial measurement technology. With these new products, Weidmüller offers the possibility of taking into account the demands of modern automation technology with the inclusion of analogue signals. These products guarantee an elementary function between signals from the field and the further processing systems. The mechanical characteristics of these products correspond to those of the well-known Weidmüller products and are part of a continuous, ongoing concept. The signal conditioners can be combined together with other Weidmüller products. They have been electrically and mechanically designed to ensure that only a minimum of wiring and maintenance costs are necessary.

The product program

contains the following functions:

- Current transformer
- Voltage transformer
- Thermocouple conditioners for resistance thermometers
- Frequency signal conditioner
- Potentiometer conditioner
- AC signal conditioner
- Bridge measurement conditioner
- Limit value monitoring modules
- AD/DA converter

These products are categorised according to functionality as pure signal conversion, 2-way-isolation, 3-way-isolation and as passive separation.



Analogue Signal Processing

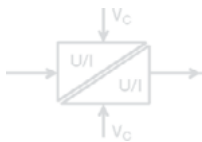

2-way-isolation separates the signals galvanically and decouples the measurement circuits. In so doing it eliminates potential differences caused by long cable lengths and common reference points. Furthermore, the galvanic isolation offers protection against destruction by overvoltage, and against inductive and capacitive interferences.

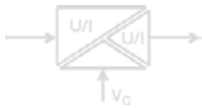

3-way-isolation also decouples the supply voltage from the input and output circuits, and enables the function with only one operating voltage.



The **passive isolator** offers a further elementary advantage; it needs no additional voltage supply. The supply to the modules ensues via the input circuit and is transferred to the output. This current loop supply is distinguished by very low power consumption.



There are a large number of products available for measuring temperatures. RTD **PT100** signals, in 2-, 3- and 4-wire technology, are converted to standardised 0 – 20 mA, 4 – 20 mA and 0 – 10 V signals.

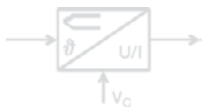

The modules which can be connected to commercially available **thermocouples** have cold junction compensation as standard. Furthermore, the modules amplify and linearize the voltage signals from the thermocouple. This guarantees an exact conditioning of analogue signals by eliminating sources of interference and errors.

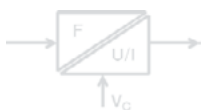

Frequency converters convert frequencies to standard analogue signals. This enables controllers connected in series to directly process impulse trains when making speed or rotational speed measurements.

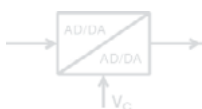

It is inconceivable to think about automation without **analogue-digital-analogue converters**. To bring together the aforementioned analogue form of describing the environment and the customary digital processing, within the framework of process monitoring, it is necessary to convert analogue signals into digital signals. Weidmüller offers modules for the following standard input and output signals: 0...20 mA, 4...20 mA and 0...10 V. 8-bit and 12-bit digital modules are available. All modules have an added input for making instantaneous measurements.



Current monitoring modules enable the monitoring of current values up to 60 A in alternating or direct voltages. Over range or under range values trip the switching output. Modules with analogue outputs enable the continuous monitoring of currents via connected controls.

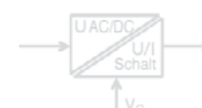

Voltage monitoring modules can be used to monitor direct and alternating voltages. Voltage fluctuations, resulting from switching operations or network overloads, can be reliably recognised and reported via the adjustable threshold function.



Modules for **monitoring of revolutions and torque** enable the control of cyclic movements on conveyor belts, ventilators and pumps. The output responds after a set amount of time, should the expected impulse not be received. The reliable potential-free relay contact, signals the interference to the responsible component group.

Design Overview

Mini Coupler / Mini Conditioner

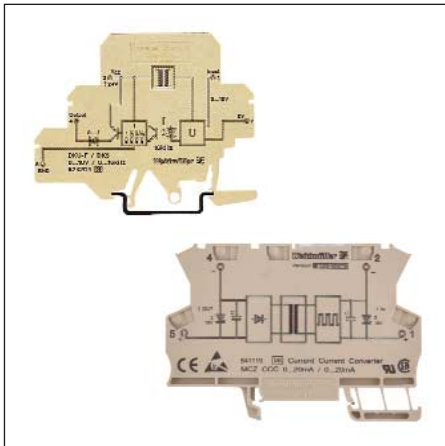

DK Mini Coupler / MCZ Mini Conditioner

- Extensive range of electronic functions in terminal format
- Pluggable cross-connections with mini conditioners
- Mini couplers with screw-in cross-connection combs
- Mini couplers with screw connections
- Mini conditioners with tension clamp connections

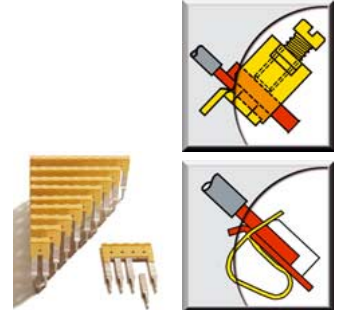

WAVESERIES

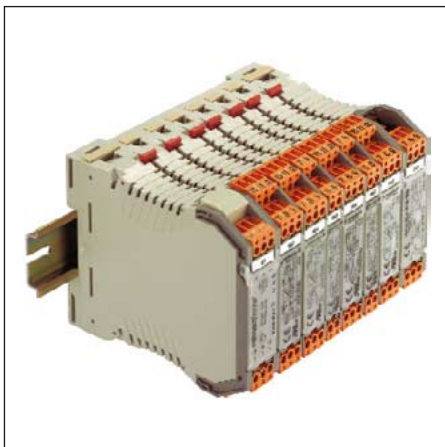

WAVEANALOG / WAVEANALOG PRO / WAVECONTROL

- Pluggable PCB for fast service when the configuration is changed
- Pluggable cross-connection in base socket housing to distribute the power supply, marking (CC) in the block diagram on the head plate
- Pluggable connections with optional screw or tension clamp connection

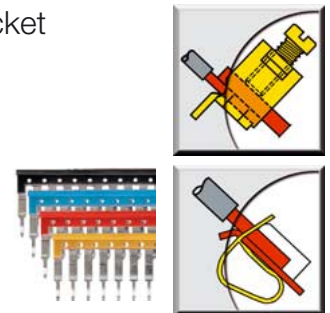

RS profiles

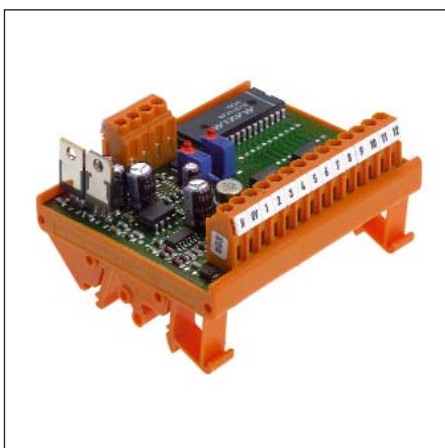

Analog-/Digital-Converters

- Mounts onto TS 32 and TS 35 mounting rails
- Open, cost-saving design
- Variable housing width

Selection Table of Functions

Function	Areas of application	Description	Versions	Page
DC signal conditioners	Signal conditioning, signal isolation, suppression of mass loops	DC input/fixed functions and configurable inputs and outputs	MCZ WAVEANALOG WAVEANALOG PRO	164 174-184 185
	Motor current limitation, pressure alarm, direct disconnection of connected modules, safety function	DC input/limit value monitoring	DK MCZ	172 173
PT100 signal conditioners	Temperature monitoring, noise rejection, electrical decoupling of visualization devices, suppression of mass loops, heating and cooling monitoring, overheating protection of motors	RTD input/fixed functions and configurable inputs and outputs	MCZ WAVEANALOG WAVEANALOG PRO	165 186-188 189
Thermocouple conditioners	Temperature monitoring, noise rejection, electrical decoupling of visualization devices, suppression of mass loops, heating and cooling monitoring, overheating protection of motors	Thermo input/fixed functions and configurable inputs and outputs	WAVEANALOG WAVEANALOG PRO	190 191
Frequency signal conditioners	Flow rate measurements, frequency converter monitoring, speed measurements, pulse processing	Input/fixed functions and configurable inputs and outputs	DK MCZ	167-168 166
AD/DA converters	Conditioning of voltage and current signals in 8-bit/12-bit digital form	8-bit AD/DA converter 12-bit AD/DA converter	RS	210-213
Current monitoring	Motor current monitoring, emergency lighting monitoring	AC input/measuring of sinusoidal and non sinusoidal signals up to 60A	DKI WAVECONTROL SMSI	172 196-199 200-203
Voltage monitoring	Under and overvoltage monitoring, operating status indication	One and three-phase overvoltage	SMSU	204-205
Motion and rotational speed monitoring	Downtime monitoring, conveyor-drive monitoring, monitoring of fans, pumps or pistons	PNP/NPN or NAMUR input/switching output	DKLW SMS	169 206
Namur switching amplifier	Switching amplifier	Namur input/switching output	EGV	207
Setpoint device	Testing measuring distances, defined input of analogue values	1 control input/+/-set value/ analogue output	EMA/SW24	208

Selection Table

Function	Input	Output	Galvanic isolation	Voltage supply	Setting	Module width/mm	Connection type	Cat. No.	Page
DC/DC	0...20mA	0...20mA	yes	Without auxiliary pwr. current loop supply from input	Fixed	6	Tens. clamp	8411190000	164
	0...20mA	0...20mA	yes	Without auxiliary pwr. current loop supply from input	Fixed	17.5	Screw/ tens. clamp	8444950000/ 8444960000 (1-channel)	174
	0...20mA	0...20mA	yes	Without auxiliary pwr. current loop supply from input	Fixed	17.5	Screw/ tens. clamp	8463580000/ 8463590000 (2-channel)	174
	0...20mA	0...20mA	2-way	19.2...28.8Vdc/ Voltage supply of both sides	Fixed	12.5	Screw/ tens. clamp	8445070000/ 8445080000	176
	0...20mA	0...20mA	yes	18...30Vdc	Fixed/10 Hz	17.5	Screw/ tens. clamp	8540180000/ 8540190000	178
	0...20mA	0...20mA	3-way	18...30Vdc	Fixed/20 kHz	17.5	Screw/ tens. clamp	8447160000/ 8447170000	181
	0...20mA	4...20mA	2-way	19.2...28.8Vdc/ Voltage supply of both sides	Fixed	12.5	Screw/ tens. clamp	8446970000/ 8446990000	176
	0...20mA	4...20mA	yes	18...30Vdc	Fixed/10 Hz	17.5	Screw/ tens. clamp	8540250000/ 8540260000	181
	0...20mA	4...20mA	3-way	18...30Vdc	Fixed/20 kHz	17.5	Screw/ tens. clamp	8447190000/ 8447200000	181
	0...20mA	0...10V	2-way	19.2...28.8Vdc/ Voltage supply of both sides	Fixed	12.5	Screw/ tens. clamp	8447020000/ 8447030000	176
	0...20mA	0...10V	yes	18...30Vdc	Fixed/10 Hz	17.5	Screw/ tens. clamp	8540270000/ 8540280000	178
	0...20mA	0...10V	3-way	18...30Vdc	Fixed/20 kHz	17.5	Screw/ tens. clamp	8447220000/ 8447230000	181
	4...20mA	0...20mA	2-way	19.2...28.8Vdc/ Voltage supply of output side	Fixed	12.5	Screw/ tens. clamp	8444980000/ 8444990000	175
	4...20mA	0...20mA	yes	18...30Vdc	Fixed/10 kHz	17.5	Screw/ tens. clamp	8540200000/ 8540210000	179
	4...20mA	0...20mA	3-way	18...30Vdc	Fixed/20 kHz	17.5	Screw/ tens. clamp	8447250000/ 8447260000	182
	4...20mA	4...20mA	2-way	19.2...28.8Vdc/ Voltage supply of output side	Fixed	12.5	Screw/ tens. clamp	8445010000/ 8445020000	175
	4...20mA	4...20mA	yes	18...30Vdc	Fixed/10 Hz	17.5	Screw/ tens. clamp	8540180000/ 8540190000	178
	4...20mA	4...20mA	3-way	18...30Vdc	Fixed/20 kHz	17.5	Screw/ tens. clamp	8447160000/ 8447170000	182
	4...20mA	0...10V	2-way	19.2...28.8Vdc/ Voltage supply of output side	Fixed	12.5	Screw/ tens. clamp	8445040000/ 8445050000	175
	4...20mA	0...10V	yes	18...30Vdc	Fixed/10 Hz	17.5	Screw/ tens. clamp	8540230000/ 8540240000	179
	4...20mA	0...10V	3-way	18...30Vdc	Fixed/20 kHz	17.5	Screw/ tens. clamp	8447280000/ 8447290000	182
	0...10V	0...20mA	2-way	19.2...28.8Vdc/ Voltage supply of both sides	Fixed	12.5	Screw/ tens. clamp	8447050000/ 8447080000	177
	0...10V	0...20mA	yes	18...30Vdc	Fixed/10 Hz	17.5	Screw/ tens. clamp	8540310000/ 8540320000	180
	0...10V	0...20mA	3-way	18...30Vdc	Fixed/20 kHz	17.5	Screw/ tens. clamp	8447310000/ 8447320000	183
	0...10V	4...20mA	2-way	19.2...28.8V/ Voltage supply of both sides	Fixed	12.5	Screw/ tens. clamp	8447100000/ 8447110000	177
	0...10V	4...20mA	yes	18...30Vdc	Fixed/10 Hz	17.5	Screw/ tens. clamp	8540290000/ 8540300000	180
	0...10V	4...20mA	3-way	18...30Vdc	Fixed/20 kHz	17.5	Screw/ tens. clamp	8447340000/ 8447350000	183
	0...10V	0...10V	2-way	19.2...28.8Vdc/ Voltage supply of both sides	Fixed	12.5	Screw/ tens. clamp	8447130000/ 8447140000	177

Selection Table

Function	Input	Output	Galvanic isolation	Voltage supply	Setting	Module width/mm	Connection type	Cat. No.	Page
	0...10V	0...10V	yes	18...30Vdc	Fixed/10 Hz	17.5	Screw/ tens. clamp	8540330000/ 8540340000	180
	0...10V	0...10V	3-way	18...30Vdc	Fixed/20 kHz	17.5	Screw/ tens. clamp	8447370000/ 8447380000	184
	Variable voltage and current (+/-20mV...+/-200V, +/-0.1mA...+/-100mA)	Variable voltage and current (-10V...+10V, -20mA...+20mA)	yes	20...253Vdc	DIP switch Potentiometer	12.5	Screw/ tens. clamp	8560740000/ 8560750000	185
	PT100/	(4)...20mA	no	19.2...28.8Vdc	DIP switch	12.5	Screw/ tens. clamp	8432210000/ 8432220000	186
RTD/DC	PT100/ 2-wire	0...10V	no	19.2...28.8Vdc	DIP switch Potentiometer	12.5	Screw/ tens. clamp	8432180000/ 8432190000	186
	PT100/ 2-wire	4...20mA	no	current loop supply in output	Fixed	6	Tens. clamp	8425720000	165
	PT100/ 3-wire	0(4)...20mA	no	19.2...28.8Vdc	DIP switch Potentiometer	12.5	Screw/ tens. clamp	8432150000/ 8432160000	187
	PT100/ 3-wire	0...10V	no	19.2...28.8Vdc	DIP switch Potentiometer	12.5	Screw/ tens. clamp	8432090000/ 8432130000	187
	PT100/0 4-wire	(4)...20mA	no	19.2...28.8Vdc	DIP switch Potentiometer	12.5	Screw/ tens. clamp	8432270000/ 8432280000	188
	PT100/ 4-wire	0...10V	no	19.2...28.8Vdc	DIP switch Potentiometer	12.5	Screw/ tens. clamp	8432240000/ 8432250000	188
	PT100/ 2-/3-/4-conduct. Ni100 Potentiometer: min. 0...100Ω max. 0...100kΩ R: 0...450Ω	0...10V 0...20mA 4...20mA	yes	18...30Vdc	DIP switch Potentiometer	17.5	Screw/ tens. clamp	8560700000/ 8560710000	189
Thermo/DC	K, J, T, E, N, R, S, B								
	Thermo K, J, T, E, N, R, S, B	0...10V 0...20mA 4...20mA	no	19.2...28.8Vdc	DIP switch	12.5	Screw/ tens. clamp	8432300000/ 8432310000	190
	Thermocouples K, J, T, E, N, R, S, B	0...10V 0...20mA 4...20mA	yes	18...30Vdc	DIP switch Potentiometer	17.5	Screw/ tens. clamp	8560720000/ 8560730000	191
Frequency/DC	0...50/100/500Hz 0...1/5/10/16kHz	0(4)...20mA	no	21.6...26.4Vdc	DIP switch	6	Screw	8311870001	168
	0...50/100/500Hz 0...1/5/10/16kHz	0(4)...20mA	no	21.6...26.4Vdc	DIP switch	6	Screw	8311870001	168
	0...50/100/500Hz 0...1/5/10/16kHz	0...10V	no	21.6...26.4Vdc	DIP switch	6	Screw	8283810000	168
	0...20mA	0...1/5/10/16kHz	no	21.6...26.4Vdc	DIP switch	6	Screw	8258870000	167
	0...20mA	0...1/5/10/16kHz	no	21.6...26.4Vdc	DIP switch	6	Tens. clamp	8461480000	166
	4...20mA	0...1/5/10/16kHz	no	current loop supply in input	DIP switch	6	Screw	8081330000	167
	4...20mA	0...1/5/10/16kHz	no	current loop supply in input	DIP switch	6	Tens. clamp	8461490000	166
	0...10V	0...1/5/10/16kHz	no	21.6...26.4Vdc	DIP switch	6	Screw	8242040000	167
	0...10V	0...1/5/10/16kHz	no	21.6...26.4Vdc	DIP switch	6	Tens. clamp	8461470000	166
	Variable, programmable	Switching output PNP	no	19.2...28.8Vdc	Fixed	12	Screw	8248340000	170- 171
Limit value monitoring	0...20mA	Switching output PNP 2-channel	no	19.2...28.8Vdc	Potentiometer	6	Screw	8031320000	172
	0...20mA	Switching output PNP 2-channel	no	19.2...28.8Vdc	Potentiometer	6	Tens. clamp	8227350000	173
	0...10V	Switching output PNP 2-channel	no	19.2...28.8Vdc	DIP switch Potentiometer	6	Screw	8019640000	172
	0...10V	Switching output PNP 2-channel	no	19.2...28.8Vdc	DIP switch Potentiometer	6	Tens. clamp	8260280000	173
AD convert.	0...20mA	8-bit	no	19.2...28.8Vdc	Fixed	70	Screw	1160561001	210
	4...20mA	8-bit	no	19.2...28.8Vdc	Fixed	70	Screw	1168561001	210
	0...10V	8-bit	no	19.2...28.8Vdc	Fixed	70	Screw	1160361001	210
		8-bit	no	19.2...28.8Vdc	Fixed	70	Screw	1122361001	210
	0...20mA	12-bit	no	19.2...28.8Vdc	Fixed	70	Screw	1168461001	212
	4...20mA	12-bit	no	19.2...28.8Vdc	Fixed	70	Screw	1169161001	212
	0...10V	12-bit	no	19.2...28.8Vdc	Fixed	70	Screw	1168361001	212
		12-bit	no	19.2...28.8Vdc	Fixed	70	Screw	1168261001	212

Selection Table

Function	Input	Output	Galvanic isolation	Voltage supply	Setting	Module width/mm	Connection type	Cat. No.	Page
DA convert.	8-bit	0...20mA	no	19.2...28.8Vdc	Fixed	70	Screw	1165860000	211
	8-bit	4...20mA	no	19.2...28.8Vdc	Fixed	70	Screw	1169260000	211
	8-bit	0...10V	no	19.2...28.8Vdc	Fixed	70	Screw	1160760000	211
	8-bit		no	19.2...28.8Vdc	Fixed	70	Screw	1123360000	211
	12-bit	0...20mA	no	19.2...28.8Vdc	Fixed	70	Screw	1166060000	213
	12-bit	4...20mA	no	19.2...28.8Vdc	Fixed	70	Screw	1165960000	213
	12-bit	0...10V	no	19.2...28.8Vdc	Fixed	70	Screw	1166160000	213
Current monitoring	0...1/5/10 Aac	1)	2-way	21.6...26.4Vdc	DIP sw./P*	22.5	Screw	8516560000	196
	0...1/5/10 Aac	1)	2-way	21.6...26.4Vdc	DIP sw./P*	22.5	Tens. clamp	8516570000	196
	0...20/40/60 Aac	1)	2-way	21.6...26.4Vdc	DIP sw./P*	22.5	Screw	8513340000	196
	0...20/40/60 Aac	1)	2-way	21.6...26.4Vdc	DIP sw./P*	22.5	Tens. clamp	8526600000	196
	0...1/5/10 Aac	2)	2-way	21.6...26.4Vdc	DIP switch	22.5	Screw	8523400000	197
	0...1/5/10 Aac	2)	2-way	21.6...26.4Vdc	DIP sw./P*	22.5	Tens. clamp	8523410000	197
	0...1/5/10 Aac	3)	2-way	12...30Vdc	DIP sw./P*	22.5	Screw	8528650000	197
	0...1/5/10 Aac	3)	2-way	12...30Vdc	DIP sw./P*	22.5	Tens. clamp	8528660000	197
	0...5/10 Aac	4)	2-way	21.6...26.4Vdc	DIP sw./P*	22.5	Screw	8526610000	198
	0...5/10 Aac	4)	2-way	21.6...26.4Vdc	DIP sw./P*	22.5	Tens. clamp	8526620000	198
	0...20/25/30 Aac	4)	2-way	21.6...26.4Vdc	DIP sw./P*	22.5	Screw	8545830000	198
	0...20/25/30 Aac	4)	2-way	21.6...26.4Vdc	DIP sw./P*	22.5	Tens. clamp	8545840000	198
	0...20/40/60 Aac	4)	2-way	21.6...26.4Vdc	DIP sw./P*	22.5	Screw	8513330000	199
	0...20/40/60 Aac	4)	2-way	21.6...26.4Vdc	DIP sw./P*	22.5	Tens. clamp	8526590000	199
	0.1...2A	Switching output PNP	no	18...30Vdc	Fixed	6	Screw		
	1...50mAdc	Opto-coupler	yes	10...250Vdc	Op. point	22.5	Screw	1157160000	200
	40...250mAdc	Opto-coupler	yes	10...250Vdc	Op. point	22.5	Screw	1156360000	200
	40...250mAdc	Opto-coupler	yes	10...250Vdc	Op. point	22.5	Screw	1156460000	201
	0.2...2.2Aac	Opto-coupler	yes	10...250Vdc	Op. point	22.5	Screw	1157360000	201
	1...5Aac	21.6...26.4Vdc	yes	10...250Vdc	Fixed	22.5	Screw	1112160000	201
	1...5Aac	5...48Vdc	yes	10...250Vdc	Fixed	22.5	Screw	8026930000	201
	1...5Aac	LED	yes	10...250Vdc	Fixed	22.5	Screw	1112060000	201
	40...250mAdc	NO 1-channel	yes	10...250Vdc	Op. point	22.5	Screw	1156660000	202
	40...250mAdc	NO 1-channel	yes	10...250Vdc	Op. point	22.5	Screw	1159960000	202
	0.2...2.2Aac	NO 1-channel	yes	10...250Vdc	Op. point	22.5	Screw	1156960000	203
	1...5Aac	NO 1-channel	yes	10...250Vdc	Fixed	22.5	Screw	1112260000	203
	Voltage monitoring	1-24Vdc	CO 1-channel	yes	21.6...26.4Vdc	Op. point	22.5	Screw	0555060000
1-230Vdc		CO 1-channel	yes	207...253Vdc	Op. point	22.5	Screw	0555160000	205
18...24Vac		CO 1-channel	yes	18...27Vac	Op. point	22.5	Screw	1156760000	204
36...48Vac		CO 1-channel	yes	36...53Vac	Op. point	22.5	Screw	1157660000	204
83...110Vac		CO 1-channel	yes	83...121Vac	Op. point	22.5	Screw	1157760000	205
165...220Vac		CO 1-channel	yes	165...253Vac	Op. point	22.5	Screw	1157860000	205
200...260Vac		NO 1-channel	yes	200...299Vac	Op. point	22.5	Screw	1160160000	205
3 phase 165...230Vac	NO 2-channel	yes	165...230Vac	Op. point	22.5	Screw	1156560000	205	
3 phase 165...230Vac	NO/NC	yes	165...230Vac	Op. point	22.5	Screw	1178760000	205	
Rotational-motion and r.p.m. monitoring	P / N. switching 24Vdc	CO 1-channel	no	195.5...241.5Vdc	Potentiometer	22.5	Screw	1110560000	206
Namur switch amplifier Setpoint device	Namur	NO 1-channel	no	21.6...26.4Vdc	no	22.5	Screw	1120360000	207
	Namur	PNP/NPN	no	21.6...26.4Vdc	no	22.5	Screw	1122460000	207
	0...24V	10.5...+10.5V	yes	21.6...26.4Vdc	Potentiometer	22.5	Screw	1172660000	208

- 1) Switch output / 1 changeover contact
- 2) 0...10 V, 0 (4)...20 mA switchable
- 3) 4...20 mA / current loop supply
- 4) Switch output / 1 changeover contact
- 5) 0...10 V, 0 (4)...20 mA switchable

DIP switch./P* = DIP switch / Potentiometer

Passive Isolator

MCZ CCC 0...20 mA/0...20 mA



This module is a reasonably priced passive separator for galvanically separating standard 0.4...20 mA signals. It draws its power from the measurement signal and requires no further auxiliary power. The measurement signal is transmitted 1:1. The module is distinguished by its low power consumption as well as a response current <math>< 100 \mu\text{A}</math>.

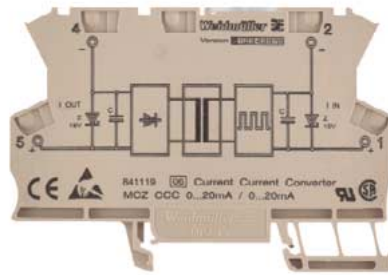

Block diagram

Working resistance diagram

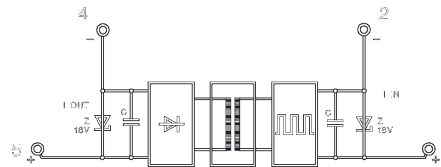
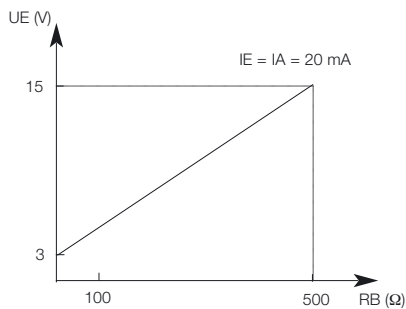

Ordering data

for TS 35

Type

MCZ CCC 0...20 mA/0...20 mA
without power supply

Cat. No.

8411190000

Technical data

Input

Response current
Voltage drop
Max. overload capacity at input

0...20 mA (max. 15 V)

<math>< 100 \mu\text{A}</math>
2.5...3 V (at 20 mA)
50 mA, 15 V

Output

Set time (T99)
Residual ripple

0...20 mA (max. 10 V)

approx. 5 ms at 500 Ω working resistance impedance
<math>< 10 \text{ mV}_{\text{eff}}</math>

Chopper frequency
Transmission error
Temperature effect

approx. 200 kHz
<math>< 0.1\%</math> from end value, +0.05% from mean/100 Ω working resistance
<math>< 50 \text{ ppm/K}</math> from measurement value for working resistance 0 Ω

Voltage strength

Input/output

510 V_{eff}

EMC

EMVG
EN 50081-1
EN 50082-2

Approvals

CE, UL, CSA

Ambient temperature

- assembled without spacing
- assembled with 20 mm spacing

-25 $^{\circ}\text{C}$...+40 $^{\circ}\text{C}$
-25 $^{\circ}\text{C}$...+50 $^{\circ}\text{C}$
-40 $^{\circ}\text{C}$...+85 $^{\circ}\text{C}$

Storage temperature

Conductor
Conductor cross-section

AWG 22...12
1.5 mm^2

Overall width

6 mm

Dimensions and accessories see

Page 305

RTD Thermocouple Conditioners

- for 2 and 3 wire sensors



The temperature module converts measurement values from a PT 100 into analogue measurement signals. The module supplies the sensor with power. The module is distinguished by its accuracy and linearity.

MCZ PT100/3 CLP

0...100 °C / 0...120 °C / 0...150 °C / 0...200 °C / 0...300 °C
 -50...+150 °C / -40...100 °C

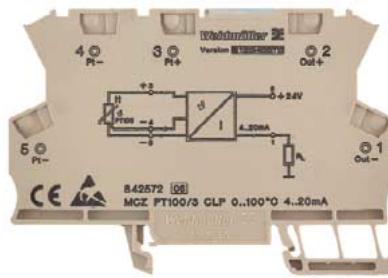

Block diagram

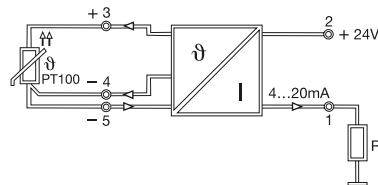

Ordering data

for TS 35

Type		Cat. No.
MCZ PT100/3 CLP	0...100 °C	8425720000
MCZ PT100/3 CLP	0...120 °C	8483680000
MCZ PT100/3 CLP	0...150 °C	8604420000
MCZ PT100/3 CLP	0...200 °C	8473010000
MCZ PT100/3 CLP	0...300 °C	8473020000
MCZ PT100/3 CLP	-50...+150 °C	8473000000
MCZ PT100/3 CLP	-40...100 °C	8604430000

Technical data

Input	PT 100 (according to IEC 751)
Connection	3-wire / 2-wire*
Max. wire resistance	each 50 Ω
Leadwire resistance effect	max. 0.006 °C/Ω
Supply current	0.8 mA
Output	4...20 mA**
Load	750 Ω at 24 V
Supply voltage	max: 30V / min: 9V+20mA x RL
Residual ripple of supply voltage	max: 1.5 V at 100 Hz
Set time	10 ms
Accuracy	Type, 0.2 % max. 0.5 % v. FSR
Linearity	<0.1 % v. FSR
Temperature coefficient	max. ±250 ppm/°C
Open circuit recognition	yes
EMC	EMVG
	EN 50081-1
	EN 50082-2
Approvals	CE, UL, CSA
Ambient temperature	0 °C...+50 °C
Storage temperature	-20 °C...+85 °C
Conductor	AWG 22...12
Conductor cross-section	1.5 mm ²
Overall width	6 mm
* Putting a bridge between Pins 4 and 5	** current loop supplied
Dimensions and accessories see	Page 305

Frequency Signal Conditioners

- Tension clamp connection
- LED-Display
- Adjustable frequency output

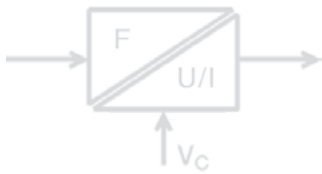

The option of reading-in the analogue signals from the field via counter inputs of the control is made possible by converting the analogue signals in to frequencies. It is recommended that twisted and shielded 2-wire cables are used.

MCZ VFC

0...10 V

MCZ CFC

0...20 mA

MCZ CFC

4...20 mA CLP

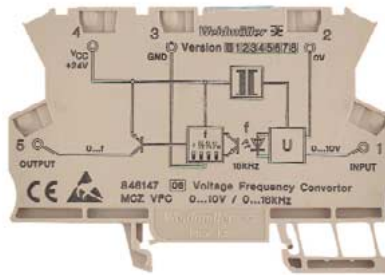

Block diagram/settings

MCZ VFZ 0...10 V and MCZ CFC 0...20 mA

1	2	3	4	DIP switch
1	0	0	0	0...16 kHz
0	1	0	0	0...8 kHz
0	0	1	0	0...4 kHz
0	0	0	1	0...1 kHz

MCZ CFC 4...20 mA CLP

1	2	3	4	DIP switch
1	0	0	0	3.2...16 kHz
0	1	0	0	1.6...8 kHz
0	0	1	0	0.8...4 kHz
0	0	0	1	0.2...1 kHz

Ordering data

for TS 35 W

Technical data

Input ranges	0...10 V
Overload limits, input	30 V
Input resistance	100 kΩ
Voltage drop, input	
Output	
Output frequency, end value	1 kHz, 4 kHz, 8 kHz, 16 kHz
Frequency adjustment	DIL switch
Readjustment range	±10 %, internal
Output level	PNP, Ub- 0.7 V
Output current	max. 20 mA
Display	LED, pulsing
Supply voltage	24 Vdc ±10 %
Power consumption	14 mA, w/o load
Making current limit	200 mA
Polarisation protection	yes

Accuracy 0.2 % v. FSR
Temperature coefficient < 250 ppm/°C

Coordination of insulation according to EN 50178

Voltage strength input/output	1 kVdc
Rated voltage	100 V
Rated surge voltage	1.5 kV
Overvoltage category	III
Voltage strength I/O to mounting rail	4 kV _{eff} / 1 min
Operating temperature	0 °C...+50 °C
Storage temperature	-25 °C...+85 °C
Overall width	6 mm
Conductor cross-section	1.5 mm ²

Dimensions and accessories see Page 305

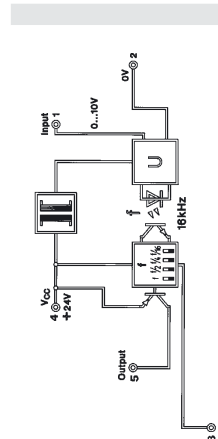

Type MCZ VFC Cat. No. 8461470000

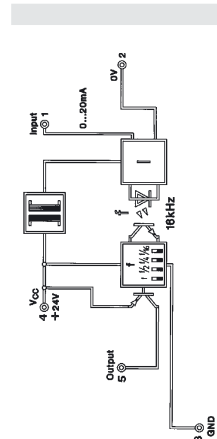

Type MCZ CFC Cat. No. 8461480000

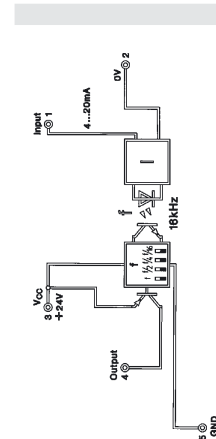

Type MCZ CFC Cat. No. 8461490000

Dimensions and accessories see Page 305

* without DC/DC converter input supply via current loop

Frequency Signal Conditioners

- Screw connection
- LED-Display
- Adjustable frequency output

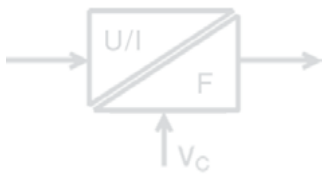

For EMC reasons, frequency processing modules must be used in conjunction with shielded cables. This measure prevents interference of analogue and frequency signals by other signal cables and vice versa.

DKA U/f

DKA I/f

DKA I/f*

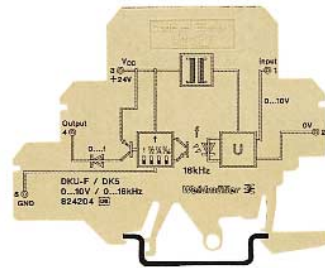

Block diagram/settings

DKA U/f and DKA I/f

1	2	3	4	DIP switch
1	0	0	0	0...16 kHz
0	1	0	0	0...8 kHz
0	0	1	0	0...4 kHz
0	0	0	1	0...1 kHz

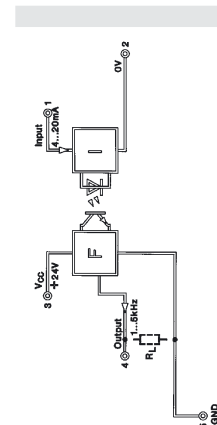
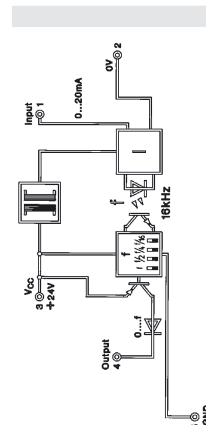
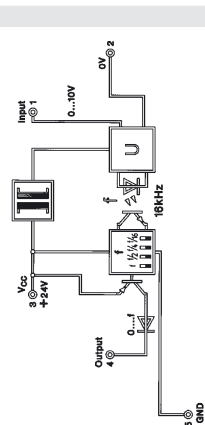

Ordering data

for TS 32	Y
for TS 35	W
with combi foot TS 32/TS 35	

Technical data

Input ranges	0...10 V
Overload limits, input	100 V
Input resistance	100 kΩ
Voltage drop, input	
Output	
Output frequency, end value	1 kHz, 4 kHz, 8 kHz, 16 kHz
Frequency adjustment	DIL switch
Readjustment range	±10 %, internal
Output level	PNP, Ub- 0.7 V
Output current	max. 20 mA
Display	LED, pulsing
Decoupling diode	present
Supply voltage	24 Vdc ±10 %
Power consumption	14 mA, w/o load
Making current limit	200 mA
Polarisation protection	yes

Accuracy	0.2 % v. FSR
	<250 ppm/°C

Coordination of insulation to DIN VDE 0160, Draft 11/94

Voltage strength input/output	1 kVdc
Rated voltage	
Rated surge voltage	
Overvoltage category	
Voltage strength to mounting rail	4 kVeff
Operating temperature	0 °C...+50 °C
Storage temperature	-25 °C...+60 °C
Overall width	6 mm
Conductor cross-section	0.5...4 mm ²

Accessories

End plate	AP DK5	8268870000
Dimensions and accessories see	Page 305	

Type	Cat. No.
DKA U/f	8242040000

Input ranges	0...10 V
Overload limits, input	100 V
Input resistance	100 kΩ
Voltage drop, input	
Output	
Output frequency, end value	1 kHz, 4 kHz, 8 kHz, 16 kHz
Frequency adjustment	DIL switch
Readjustment range	±10 %, internal
Output level	PNP, Ub- 0.7 V
Output current	max. 20 mA
Display	LED, pulsing
Decoupling diode	present
Supply voltage	24 Vdc ±10 %
Power consumption	14 mA w/o load
Making current limit	200 mA
Polarisation protection	yes
Accuracy	0.2 % v. FSR
	<250 ppm/°C

Voltage strength input/output	1 kVdc
Rated voltage	
Rated surge voltage	
Overvoltage category	
Voltage strength to mounting rail	4 kVeff
Operating temperature	0 °C...+50 °C
Storage temperature	-25 °C...+60 °C
Overall width	6 mm
Conductor cross-section	0.5...4 mm ²

Type	Cat. No.
AP DK5	8268870000
Page 305	

Type	Cat. No.
DKA I/f	8258870000

Input ranges	0...20 mA
Overload limits, input	50 mA
Input resistance	50 Ω
Voltage drop, input	1 V at 20 mA
Output	
Output frequency, end value	1 kHz, 4 kHz, 8 kHz, 16 kHz
Frequency adjustment	DIL switch
Readjustment range	±10 %, internal
Output level	PNP, Ub- 0.8 V
Output current	max. 20 mA
Display	LED, pulsing
Decoupling diode	present
Supply voltage	24 Vdc ±10 %
Power consumption	14 mA w/o load
Making current limit	200 mA
Polarisation protection	yes
Accuracy	0.2 % v. FSR
	<250 ppm/°C

Voltage strength input/output	1 kVdc
Rated voltage	
Rated surge voltage	
Overvoltage category	
Voltage strength to mounting rail	4 kVeff
Operating temperature	0 °C...+50 °C
Storage temperature	-25 °C...+60 °C
Overall width	6 mm
Conductor cross-section	0.5...4 mm ²

Type	Cat. No.
AP DK5	8268870000
Page 305	

Type	Cat. No.
DKA I/f *	8081330000

Input ranges	4...20 mA
Overload limits, input	50 mA
Input resistance	max. 320 Ω at 20 mA
Voltage drop, input	max. 6.4 V at 20 mA
Output	
Output frequency, end value	5 kHz (1...5 kHz)
Frequency adjustment	
Readjustment range	
Output level	Ub- 3 V
Output current	max. 20 mA
Display	
Decoupling diode	present
Supply voltage	19.2...28.8 Vdc
Power consumption	<13 mA w/o load
Making current limit	
Polarisation protection	yes
Accuracy	0.15 % v. FSR
	<250 ppm/°C 2

Voltage strength input/output	4 kVeff
Rated voltage	150 V
Rated surge voltage	2.5 kV
Overvoltage category	III
Voltage strength to mounting rail	4 kVeff
Operating temperature	0 °C...+50 °C
Storage temperature	-25 °C...+60 °C
Overall width	6 mm
Conductor cross-section	0.5...4 mm ²

Type	Cat. No.
AP DK5	8268870000
Page 305	

* without DC/DC converter
Input current loop supplied

Frequency Signal Conditioners

- Screw connection
- LED-Display
- Adjustable frequency output
- multiplex capable

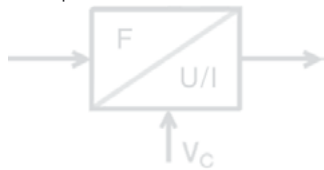

For EMC reasons, frequency processing modules must be used in conjunction with shielded cables. This measure prevents interference of analogue and frequency signals by other signal cables and vice versa.

DKA f/U

DKA f/I

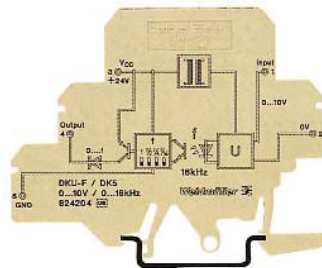

Block diagram/settings

1	2	3	4	DIP switch
0	0	0	X	0...50 Hz
1	0	0	X	0...100 Hz
0	1	0	X	0...500 Hz
1	1	0	X	0...1 kHz
0	1	1	X	0...5 kHz
1	0	1	X	0...10 kHz
1	1	1	X	0...16 kHz
0	0	1	X	Customer specific
X	X	X	0	0...20 mA / 0...10 V
X	X	X	1	4...20 mA / 2...10 V

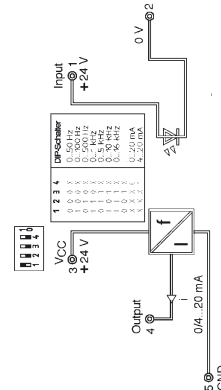
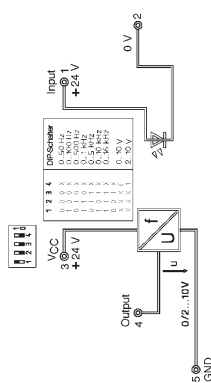

Ordering data

for TS 32	Y
for TS 35	W
with combi foot TS 32/TS 35	

Technical data

Input ranges	
Overload limits, input	
Input resistance	
Voltage drop, input	
Output	
Output frequency, end value	
Frequency adjustment	
Readjustment range	
Output level	
Output current	
Display	
Decoupling diode	
Supply voltage	24 Vdc ±10 %
Power consumption	32 mA + I _{Load}
Making current limit	
Polarisation protection	yes
Accuracy	0.5 % (8-bit resolution)

Coordination of insulation to DIN VDE 0160, Draft 11/94

Voltage strength input/output	2.5 kV
Rated voltage	
Rated surge voltage	
Overvoltage category	
Voltage strength to mounting rail	4 kV _{eff}
Operating temperature	0 °C...+50 °C
Storage temperature	-25 °C...+60 °C
Overall width	6 mm
Conductor cross-section	0.5...4 mm ²

Dimensions and accessories see

Type Cat. No.

DKA f/U **8283810001**

0...50/100/500 Hz
0...1/5/10/16 kHz

10 kΩ

0/2...10 V

DIL switch

24 Vdc ±10 %

32 mA + I_{Load}

yes

0.5 % (8-bit resolution)

2.5 kV

4 kV_{eff}

0 °C...+50 °C

-25 °C...+60 °C

6 mm

0.5...4 mm²

Page 305

Type Cat. No.

DKA f/I **8311870001**

0...50/100/500 Hz
0...1/5/10/16 kHz

10 kΩ

0/4...20 mA

DIL switch

24 Vdc ±10 %

32 mA + I_{Load}

yes

0.5 % (8-bit resolution)

2.5 kV

4 kV_{eff}

0 °C...+50 °C

-25 °C...+60 °C

6 mm

0.5...4 mm²

Page 305

Monitoring Revolutions

DK LW

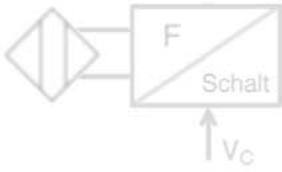

If only one revolution limit is to be evaluated, the potentiometer for f_{max} must be set to end stop or the potentiometer for f_{min} to left stop. Then only the other is in each case active for setting the limit value.

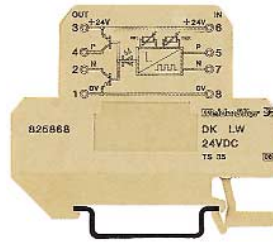

Block diagram/settings

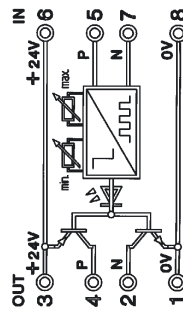

Ordering data	Type	Cat. No.
for TS 32		Y
for TS 35		W
Technical data		
Input	Initiators, NPN or PNP	
Number of inputs	1	
Input frequency	10 - 6250 U/min.	
Range selection	3 switchable revolutions ranges: 10-130, 100-1300, 1000-7800 r.p.m.	
Fine adjustment	2 potentiometers for upper/lower revs limit	
Input nominal level	24 Vdc = High, 0 V = Low	
Overload limits	30 Vdc	
Switching threshold	High >18 V, Low <7 V	
Pulse duration	>0.5 ms	
Input current	approx. 3.5 mA (24 V)	
Reverse polarity protection	yes	
Output	Optional PNP or NPN	
Function	Output active, if f within set revs limit	
Output level	Ub- 1.8 V	
Output current	20 mA max.	
Decoupling diode	yes	
Status LED	green LED	
Short-circuit proof	no	
Operating voltage	24 V -10 % + 20 %	
Power consumption	<10 mA, w/o load, without initiator	
Reverse polarity protection	yes	
Galvanic isolation	no	
Voltage strength to mounting rail	4 kV _{eff}	
Operating temperature	0...+50 °C	
Storage temperature	-40...+60 °C	
Overall width	12 mm	
Conductor cross-section	0.5...4 mm ²	
Insulation stripping length	7 mm	
Others	Initiator power supply via module possible	
Accessories	Type	Cat. No.
End plate	AP DKT4	0687560000
Dimensions and accessories see	Page 278	

Preprocessing Logic

- Screw connection
- logic function and time function combined
- individually programmable (further functions on request)

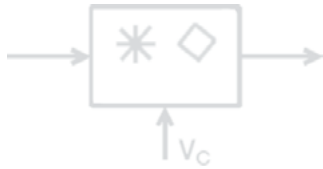

DK PL

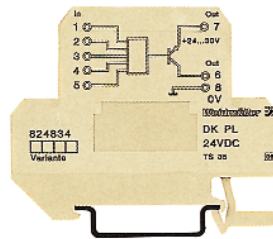

Block diagram

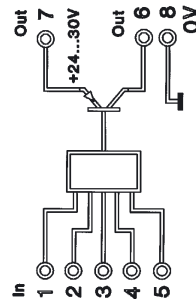

Ordering data

for TS 32	Y
for TS 35	W

Type	Cat. No.
on request	
DK PL	824834000*

Technical data

Logical function	Programmable, see note
Number of inputs	5
Input nominal level	24 Vdc = High, 0 V = Low
Overload limits	30 Vdc
Switching threshold	High >18 V, Low <7 V
Pulse duration	>1 ms
Input current	approx. 1.5 mA per input (24 V)
Output	PNP
Output level	U _b - 1 V
Output current	20 mA max.
Decoupling diode	no
Status LED	green LED
Short-circuit proof	no
Operating voltage	24 V ±20 %
Power consumption	<10 mA
Reverse polarity protection	yes
Galvanic isolation	no
Voltage strength to mounting rail	4 kV _{eff}
Operating temperature	0 °C...+50 °C
Storage temperature	-40 °C...+60 °C
Overall width	12 mm
Conductor cross-section	0.5...4 mm ²
Insulation stripping length	7 mm

Accessories

Type	Cat. No.
End plate	AD DKT4
Ordering example: RS FLIP-FLOP	8248340002
Dimensions see	Page 278

* (not programmed - function next page)

Remark:

The module is programmed according to customers specifications. Up to 5 inputs can be linked with various logic and timer functions, e.g.: AND, OR, EXOR, NAND, NOR, EXNOR, delay elements, etc. The output is either low or high active.

824834 0001 DKPL
A = (E1 OR E2) AND (E3 OR E4) AND E5

State	5	4	3	2	1	Output
1	0	0	0	0	0	0
2	0	0	0	0	1	0
3	0	0	0	1	0	0
4	0	0	0	1	1	0
5	0	0	1	0	0	0
6	0	0	1	0	1	0
7	0	0	1	1	0	0
8	0	0	1	1	1	0
9	0	1	0	0	0	0
10	0	1	0	0	1	0
11	0	1	0	1	0	0
12	0	1	0	1	1	0
13	0	1	1	0	0	0
14	0	1	1	0	1	0
15	0	1	1	1	0	0
16	0	1	1	1	1	0
17	1	0	0	0	0	0
18	1	0	0	0	1	0
19	1	0	0	1	0	0
20	1	0	0	1	1	0
21	1	0	1	0	0	0
22	1	0	1	0	1	1
23	1	0	1	1	0	1
24	1	0	1	1	1	1
25	1	1	0	0	0	0
26	1	1	0	0	1	1
27	1	1	0	1	0	1
28	1	1	0	1	1	1
29	1	1	1	0	0	0
30	1	1	1	0	1	1
31	1	1	1	1	0	1
32	1	1	1	1	1	1

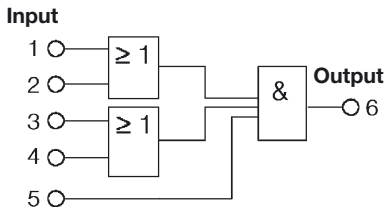

824834 0002 DKPL
Inputs 1 and 2 have the function of a RS FLIP-FLOP
Inputs 3, 4 and 5 have no function

Input	Output
2 1	6
0 0	0 (is stored)
0 1	No change of stored state
1 0	No change of stored state
1 1	1 (is stored)
Inputs 3, 4 and 5 no function	No change of stored state

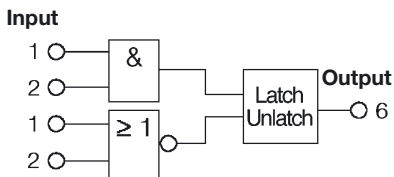

824834 0003 DKPL - Frequency divider
Inputs 1 - 5 determine the divider factor
Input 1 = divider factor 1: $f_{out} = f_{in} / 1$
Input 2 = divider factor 2: $f_{out} = f_{in} / 2$
Input 5 = divider factor 5: $f_{out} = f_{in} / 5$; $f_{in} \text{ max.} = 12 \text{ kHz}$

Input	Output
1	$f_{out} = f_{in}$
2	$f_{out} = f_{in} / 2$
3	$f_{out} = f_{in} / 3$
4	$f_{out} = f_{in} / 4$
5	$f_{out} = f_{in} / 5$

Note: An new divider factor can only be used if operating voltage is switched off. $f_{in} \text{ max.} = 12 \text{ kHz}$

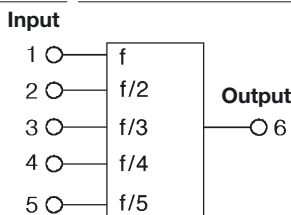

824834 0004 DKPL
Input 1: Signal A of an incremental generator
Input 2: Signal B 90° is shifted
Input 3: Enable High Active
Input 4: Output signal inverts High Active
Input 5: No function
Output: For each slope of signal A or B, the output is set to 20 - 30 Us.
(I.e.: $f_{out} = 4 \times f_{in}$)
 $f_{in} \text{ max.} = 1 \text{ kHz}$

Connection	Description
1	A Signal A 90° leading $f_{max} = 1 \text{ kHz}$
2	B Signal B 90° following $f_{max} = 1 \text{ kHz}$
3	Enable Output is released
4	Invert Output signal invert
5	No function
6	$f_{out} = 4 \times f_{in}$ (max. 4 kHz)

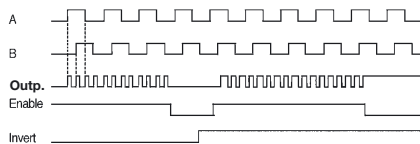
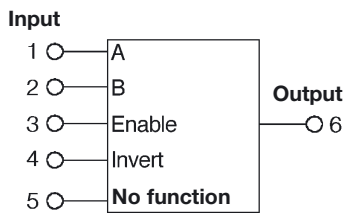

824834 0005 DKPL
Length of input signal between 80 and 100 ms.
Length of output signal 100 ms, only 2 pulses,
Relation pulse-interruption 1:1.
The positive slope of the input signal has to be analysed. Only input E1 is used.

824834 0006 DKPL
Input 1: $f_{out} = f_{in}$
Input 2: $f_{out} = f_{in} / 10$

Input	Output
1	$f_{out} = f_{in}$
2	$f_{out} = f_{in} / 10$
3	$f_{out} = f_{in} / 50$
4	$f_{out} = f_{in} / 100$
5	$f_{out} = f_{in} / 1000$

Note: A new divider factor can only be used if the operating voltage is switched off. $f_{in} \text{ max.} = 3 \text{ kHz}$

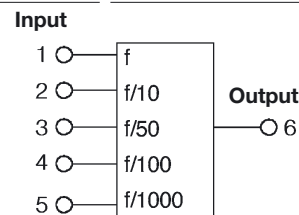

824834 007 DKPL

Input	Output
1 2 3 4 5	Out
L L X X X	No function
H L X X X	$f = 1 \text{ Hz}$
L H X X X	$f = 10 \text{ Hz}$
H H X X X	$f = 1 \text{ Hz}$

L -> 0 V or connection open
H -> +24 ...30 Vdc
X -> no effect on output function, L or H

824834 0008 DKPL

Input	Output
1 2	6
H H	H
L H	L

824834 0010 DKPL
RS FLIP-FLOP with superior S - input (connection 2)
Input connections 3, 4 and 5 must have 0 V or remain open!

Connection 1 Logic	Connection 2 S-Input	Logic	Connection 6 Output
0 V or open	L	0 V or open	L
+24 Vdc	H	0 V or open	L
0 V or open	L	+24 Vdc	H
+24 Vdc	H	+24 Vdc	H

824834 0501 DKPL
The module allows the input frequency at connection 1 (0...max. 50 kHz) to be divided with 2 fixed divider factors. Depending on connection 2, the output frequency is transmitted from output connection 6.
Connections 3, 4 and 5 have no function.

Connect. 2 Logic	Factor	Inp. frequency	Outp. frequency
0 V or open	L	0...30 kHz	0...400 Hz
+24 Vdc	H	0...10.8 kHz	0...400 Hz

Threshold Monitoring

Current sensor

- Screw connection
- Mounts onto on mounting rail
- Wide spectrum of functions
- In part, individually adjustable

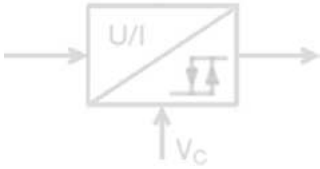

DKSC 0-10 V

DKSC 0-20 mA

DKI 2A

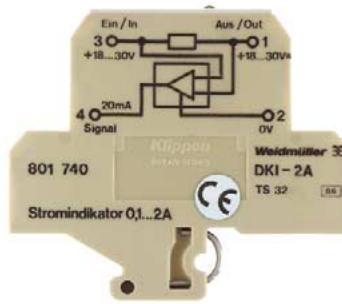

Block diagram/settings

S1	S2	DIP switch
on	on	10...100 mV
on	off	30 mV...1 V
off	X	300 mV...10 V

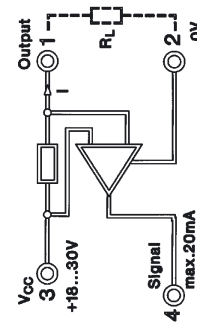
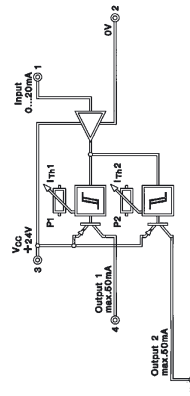
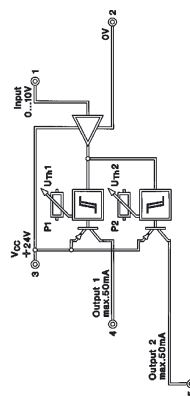

Ordering data

for TS 32	Y
for TS 35	W
with combi foot TS 32/TS 35	

Technical data

Input signal	0...10 V
Input resistance	60 kΩ
Voltage drop, input	1 V
Cut-off frequency	100 Hz
Switchable input range	DIL switch for 3 ranges
Switching point settings	2 threshold Uth 1 and Uth 2 with 2 front potentiometers each 1 %
Hysteresis	each 1 %
Output	double switch output
Output level	per PNP, Ub- 1.2 V
Output current	50 mA
Function	lin <Uth1: output 1 active lin >Uth2: output 2 active
Status LED	no
Operating voltage	24 Vdc ±20 %
Power consumption	approx. 15 mA
Galvanic isolation	no
Voltage strength to mounting rail	4 kVeff
Operating temperature	0 °C...+50 °C
Storage temperature	-25 °C...+60 °C
Overall width	6 mm
Conductor cross-section	0.5...4 mm ²

Type Cat. No.

DKSC 0-10 V **8019640000**

Type Cat. No.

DKSC 0-20 mA **8031320000**

Type Cat. No.

DKI 2A **8017400000**
DKI 2A **8017410000**

EMC resistance

Burst acc. to EN 61000-4-4	Input/outputs	Test severity 4, self restoring
	Power supply	Test severity 4, self restoring
ESD acc. to EN 61000-4-2	Contact discharge	Test severity 4
	Air discharge	Test severity 3

Accessories

End plate	AP DK5	8268870000
Dimensions see	Page 278	

Type Cat. No.

AP DK5 **8268870000**

Page 278

Type Cat. No.

AP DKT4 **0687560000**

Page 278

Threshold Monitoring

MCZ SC 0...10 Vdc

MCZ SC 0...20 mA

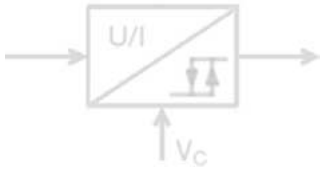

The Setpoint Controller allows cost effective units to be built for monitoring analogue signals. An upper and lower limit value, which covers the entire signal range, can be set by the user via 2 potentiometers. The respective statuses of the upper and lower limit value are indicated at the 2 digital outputs (upper limit value under/over flow; lower limit value under/over flow).

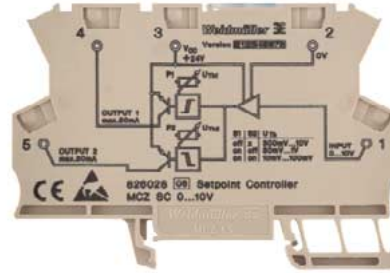

Block diagram

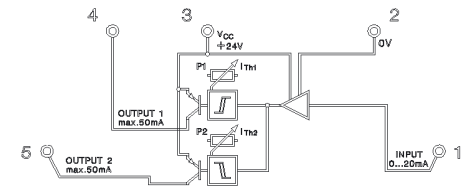
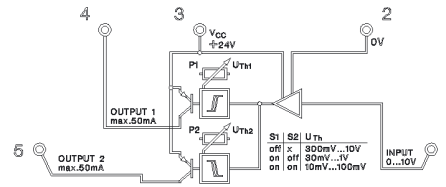

Ordering data	Type	Cat. No.	Type	Cat. No.
for TS 35	MCZ SC 24 V/0...10V	8260280000	MCZ SC 24 V/0...20 mA	8227350000
Technical data				
Voltage supply				
Supply voltage	24 Vdc ± 20 %		24 Vdc ± 20 %	
Supply current	15 mA		15 mA	
Input				
Input voltage	0...10 V		0.5...20 mA	
Input resistance	60 kΩ		50 Ω	
Voltage drop at full scale			1 V	
Max. input current			40 mA	
Cut-off frequency	100 Hz		100 Hz	
Transmission behaviour				
Threshold voltage ranges of U_{th}		S1 S2 Temperature coefficient T_k		Temperature coefficient T_k 250 ppm max.
	10...100 mV	on on 500 ppm max.		
	0.03...1 V	on off 250 ppm max.		
	0.3...10 V	off x 250 ppm max.		
Setting of switching threshold	via 2 potentiometers (12 turns)		via 2 potentiometers (12 turns)	
Hysteresis of switching threshold	1 % of the end value		1 % of the end value	
Function of output 1	active High for $U_{input} < U_{th1}$ (set via P1)		active High for $I_{input} < I_{th1}$ (set via P1)	
Function of output 2	active High for $U_{input} > U_{th2}$ (set via P2)		active High for $I_{input} > I_{th2}$ (set via P2)	
Response time	< 250 μs (switch threshold at 90% of the max. input signal; $R_L \leq 1$ kΩ)		< 250 μs (switch threshold at 90% of the max. input signal; $R_L \leq 1$ kΩ)	
Output				
Output current per output	2 channel switching PNP		2 channel switching PNP	
Voltage drop at output transistor	max. 50 mA		max. 50 mA	
	< 1.2 V at 50 mA		< 1.2 V at 50 mA	
Insulation coordination/safe separation to EN 50178				
Separation input / output	none		none	
Dielectric strength I/O to mounting rail	4 kVeff / 1 min		4 kVeff / 1 min	
Ambient temperature	0 °C...+50 °C		0 °C...+50 °C	
Storage temperature	-25 °C...+60 °C		-25 °C...+60 °C	
Conductor	AWG 22...12		AWG 22...12	
Conductor cross-section	1.5 mm ²		1.5 mm ²	
Approvals	CE, UL, CSA		CE, UL, CSA	
Overall width	6 mm		6 mm	
Dimensions and accessories see	Page 305		Page 305	

Passive Isolator DC/DC

WAVEANALOG DC/DC

- input loop powered
- galvanic isolation
- 1-, 2-channel versions
- low power consumption
- safe separation

Approvals:



Block diagram



CCC LP (1 channel)

0(4) ... 20 mA / 0(4) ... 20 mA

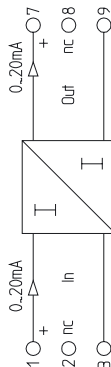

CCC LP (2 channel)

0(4) ... 20 mA / 0(4) ... 20 mA

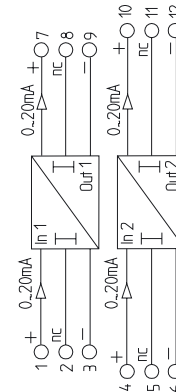

Ordering data

Screw connection 1 channel	
Tension clamp connection 1 channel	
Screw connection 2 channel	
Tension clamp connection 2 channel	
Input/output	

Type	Cat. No.
WAS5 CCC LP	8444950000
WAZ5 CCC LP	8444960000
0(4) ... 20 mA / 0(4) ... 20 mA	

Type	Cat. No.
WAS5 CCC LP	8463580000
WAZ5 CCC LP	8463590000
0(4) ... 20 mA / 0(4) ... 20 mA	

Technical data* (per channel)

Input signal	
Input voltage max.	18 V
Input current max	50 mA
Operating current	< 100 μ A
Voltage drop	approx. 3 V at $R_L = 0 \Omega$ $I_{in} = 20$ mA approx. 13 V at $R_L = 500 \Omega$ at $I_{in} = 20$ mA
Output signal	
Load resistance	0 ... 20 mA (4 ... 20 mA) $\leq 500 \Omega$
Accuracy at $T_U = 23^\circ\text{C}$	< 0.1% of FS
Influence of load resistance	< 0.1% from measurement value per 100 Ω load resistance
Temperature coefficient	50 ppm / K of FS
Set time	4.5 ms at 500 Ω working resistance
Residual ripple	< 20 mV _{eff}
Chopper frequency	approx. 170 kHz

0 ... 20 mA (4 ... 20 mA)	
18 V	
50 mA	
< 100 μ A	
approx. 3 V at $R_L = 0 \Omega$ $I_{in} = 20$ mA approx. 13 V at $R_L = 500 \Omega$ at $I_{in} = 20$ mA	
0 ... 20 mA (4 ... 20 mA) $\leq 500 \Omega$	
< 0.1% of FS	
< 0.1% from measurement value per 100 Ω load resistance	
50 ppm / K of FS	
4.5 ms at 500 Ω working resistance	
< 20 mV _{eff}	
approx. 170 kHz	

0 ... 20 mA (4 ... 20 mA)	
18 V	
50 mA	
< 100 μ A	
approx. 3 V at $R_L = 0 \Omega$ $I_{in} = 20$ mA approx. 13 V at $R_L = 500 \Omega$ at $I_{in} = 20$ mA	
0 ... 20 mA (4 ... 20 mA) $\leq 500 \Omega$	
< 0.1% of FS	
< 0.1% from measurement value per 100 Ω load resistance	
50 ppm / K of FS	
4.5 ms at 500 Ω working resistance	
< 20 mV _{eff}	
approx. 170 kHz	

General

Operating temperature	-25 $^\circ\text{C}$... +70 $^\circ\text{C}$
Storage temperature	-40 $^\circ\text{C}$... +80 $^\circ\text{C}$
Dimensions L / H / W mm	92.4 / 112.5 / 17.5
Approvals	CE, UL, CSA, GL

-25 $^\circ\text{C}$... +70 $^\circ\text{C}$	
-40 $^\circ\text{C}$... +80 $^\circ\text{C}$	
92.4 / 112.5 / 17.5	
CE, UL, CSA, GL	

-25 $^\circ\text{C}$... +70 $^\circ\text{C}$	
-40 $^\circ\text{C}$... +80 $^\circ\text{C}$	
92.4 / 112.5 / 17.5	
CE, UL, CSA, GL	

Coordination of insulation according to EN 50178, 04/98 (safe separation)

Rated voltage	300 V
Rated surge voltage	6 kV
Overtoltage category	III
Contamination class	2
Clearance and creepage distance	≥ 5.5 mm
Isolation voltage, voltage strength	
Input/output, channel / channel	4 kV _{eff} / 1 s
Input/output to mounting rail	4 kV _{eff} / 1 min
Standards/specifications	EN 50178 (safe separation)
EMC standards	EN 50081, EN 50082, EN 55011
Dimensions and accessories see	Page 298 + 308

300 V	
6 kV	
III	
2	
≥ 5.5 mm	
4 kV _{eff} / 1 s	
4 kV _{eff} / 1 min	
EN 50178 (safe separation)	
EN 50081, EN 50082, EN 55011	
Page 298 + 308	

300 V	
6 kV	
III	
2	
≥ 5.5 mm	
4 kV _{eff} / 1 s	
4 kV _{eff} / 1 min	
EN 50178 (safe separation)	
EN 50081, EN 50082, EN 55011	
Page 298 + 308	

DC/DC-Signal Conditioners

WAVEANALOG DC/DC

- voltage supply on output side
- 2-way-isolation
- analogue signal conditioning
- galvanic isolation between input/output signal
- Input loop powered
- cross-connectable voltage supply via cross-connectors

Approvals:



Block diagram

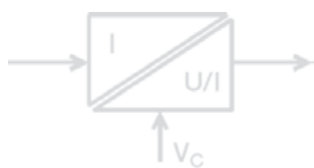

CCC DC

4 ... 20 mA / 4 ... 20 mA



CCC DC

4 ... 20 mA / 0 ... 20 mA



CVC DC

4 ... 20 mA / 0 ... 10 V

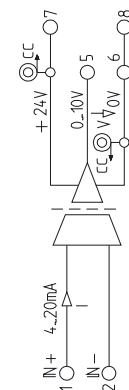
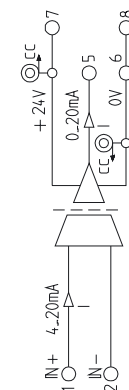
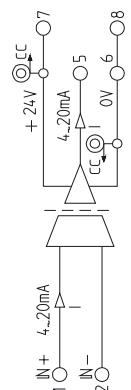

Ordering data

Screw connection

Tension clamp connection

Input/output

Type	Cat. No.
WAS4 CCC DC	8444980000
WAZ4 CCC DC	8444990000

Type	Cat. No.
WAS4 CCC DC	8445010000
WAZ4 CCC DC	8445020000

Type	Cat. No.
WAS4 CVC DC	8445040000
WAZ4 CVC DC	8445050000

Technical data*

Input signal

Input voltage max.

Input current max

Output signal

Load resistance

Accuracy at $T_U=23\text{ }^\circ\text{C}$

Temperature coefficient

Response time

Cut-off frequency (-3 dB)

4 ... 20 mA

7 V

25 mA

4 ... 20 mA

$\leq 500\ \Omega$

$\pm 0.2\%$ of FS

$\leq 250\text{ ppm / K of FS}$

$\leq 30\text{ ms (typ. 20 ms)}$

$\geq 15\text{ Hz (typ. 20 Hz)}$

4 ... 20 mA

7 V

25 mA

0 ... 20 mA

$\leq 500\ \Omega$

$\pm 0.2\%$ of FS

$\leq 250\text{ ppm / K of FS}$

$\leq 30\text{ ms (typ. 20 ms)}$

$\geq 15\text{ Hz (typ. 20 Hz)}$

4 ... 20 mA

7 V

25 mA

0 ... 10 V

$\geq 1\text{ k}\Omega$

$\pm 0.2\%$ of FS

$\leq 250\text{ ppm / K of FS}$

$\leq 30\text{ ms (typ. 20 ms)}$

$\geq 15\text{ Hz (typ. 20 Hz)}$

General

Voltage supply

Power consumption

Current carrying capacity of cross-connection

Operating temperature

Storage temperature

Dimensions L / H / W mm

Approvals

24 Vdc $\pm 20\%$

(19.2 ... 28.8 Vdc)

$< 32\text{ mA at } I_{out} = 20\text{ mA}$

$\leq 2\text{ A}$

0 $^\circ\text{C}$... +55 $^\circ\text{C}$ (mounted)

-20 $^\circ\text{C}$... +85 $^\circ\text{C}$

92.4 / 112.5 / 12.5

CE, UL, CSA

24 Vdc $\pm 20\%$

(19.2 ... 28.8 Vdc)

$< 32\text{ mA at } I_{out} = 20\text{ mA}$

$\leq 2\text{ A}$

0 $^\circ\text{C}$... +55 $^\circ\text{C}$ (mounted)

-20 $^\circ\text{C}$... +85 $^\circ\text{C}$

92.4 / 112.5 / 12.5

CE, UL, CSA

24 Vdc $\pm 20\%$

(19.2 ... 28.8 Vdc)

$< 20\text{ mA at } I_{out} = 10\text{ mA}$

$\leq 2\text{ A}$

0 $^\circ\text{C}$... +55 $^\circ\text{C}$ (mounted)

-20 $^\circ\text{C}$... +85 $^\circ\text{C}$

92.4 / 112.5 / 12.5

CE, UL, CSA

Coordination of insulation according to EN 50178, 04/98

Rated voltage

Rated surge voltage

Overvoltage category

Contamination class

Clearance and creepage distance

Isolation voltage, voltage strength

Input/output to mounting rail

300 V

4 kV

III

2

$\geq 3\text{ mm}$

4 kV_{eff} / 1 min

300 V

4 kV

III

2

$\geq 3\text{ mm}$

4 kV_{eff} / 1 min

300 V

4 kV

III

2

$\geq 3\text{ mm}$

4 kV_{eff} / 1 min

Standards/specifications

EMC standards

EN 50178

EN 50081, EN 50082,

EN 55011

EN 50178

EN 50081, EN 50082,

EN 55011

EN 50178

EN 50081, EN 50082,

EN 55011

Dimensions and accessories see

* $T_U = 23\text{ }^\circ\text{C}$ single module

Page 298 + 308

Page 298 + 308

Page 298 + 308

DC/DC-Signal Conditioners

WAVEANALOG DC/DC

- voltage supply on both sides
- 2-way-isolation
- analogue signal conditioning
- galvanic isolation between input/output signal
- cross-connectable voltage supply via cross-connectors

Approvals:



Block diagram

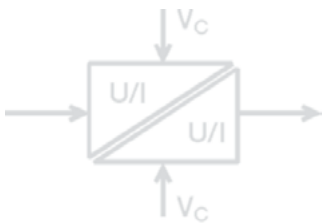

CCC DC

0 ... 20 mA / 0 ... 20 mA



CCC DC

0 ... 20 mA / 4 ... 20 mA



CVC DC

0 ... 20 mA / 0 ... 10 V

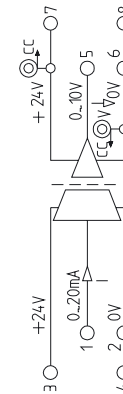
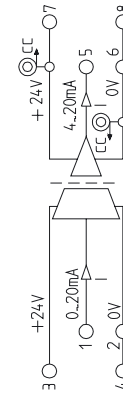
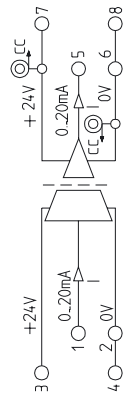

Ordering data

Screw connection	Type	Cat. No.
Tension clamp connection	WAS4 CCC DC	8445070000
Input/output	WAZ4 CCC DC	8445080000

Type	Cat. No.
WAS4 CCC DC	8445070000
WAZ4 CCC DC	8445080000

Type	Cat. No.
WAS4 CCC DC	8446970000
WAZ4 CCC DC	8446990000

Type	Cat. No.
WAS4 CVC DC	8447020000
WAZ4 CVC DC	8447030000

Technical data*

Input signal	0 ... 20 mA
Input current max	25 mA
Input resistance	50 Ω
Output signal	0 ... 20 mA
Load resistance	≤ 500 Ω
Accuracy at Tu=23 °C	± 0.2% of FS
Temperature coefficient	≤ 250 ppm / K of FS
Response time	≤ 30 ms (typ. 16 ms)
Cut-off frequency (-3 dB)	≥ 15 Hz (typ. 25 Hz)

Type	Cat. No.
WAS4 CCC DC	8445070000
WAZ4 CCC DC	8445080000

Type	Cat. No.
WAS4 CCC DC	8446970000
WAZ4 CCC DC	8446990000

Type	Cat. No.
WAS4 CVC DC	8447020000
WAZ4 CVC DC	8447030000

General

Voltage supply	24 Vdc ±20% (19.2 ... 28.8 Vdc)
Power consumption input	< 11 mA at I _{in} = 20 mA
Power consumption output	< 32 mA at I _{out} = 20 mA
Current carrying capacity of cross-connection	≤ 2 A
Operating temperature	0 °C ... +55 °C (mounted)
Storage temperature	-20 °C ... +85 °C
Dimensions L / H / W mm	92.4 / 112.5 / 12.5
Approvals	CE, UL, CSA

Type	Cat. No.
WAS4 CCC DC	8445070000
WAZ4 CCC DC	8445080000

Type	Cat. No.
WAS4 CCC DC	8446970000
WAZ4 CCC DC	8446990000

Type	Cat. No.
WAS4 CVC DC	8447020000
WAZ4 CVC DC	8447030000

Coordination of insulation according to EN 50178, 04/98

Rated voltage	300 V
Rated surge voltage	4 kV
Overvoltage category	III
Contamination class	2
Clearance and creepage distance	≥ 3 mm
Isolation voltage, voltage strength	≥ 3 mm
Input/output to mounting rail	4 kV _{eff} / 1 min
Standards/specifications	EN 50178
EMC standards	EN 50081, EN 50082, EN 55011
Dimensions and accessories see	Page 298 + 308

Type	Cat. No.
WAS4 CCC DC	8445070000
WAZ4 CCC DC	8445080000

Type	Cat. No.
WAS4 CCC DC	8446970000
WAZ4 CCC DC	8446990000

Type	Cat. No.
WAS4 CVC DC	8447020000
WAZ4 CVC DC	8447030000

*Tu = 23 °C single module

DC/DC Signal Conditioners

WAVEANALOG DC/DC

- voltage supply on both sides
- 2-way-isolation
- analogue signal conditioning
- galvanic isolation between input/output signal
- cross-connectable voltage supply via cross-connectors

Approvals:



Block diagram

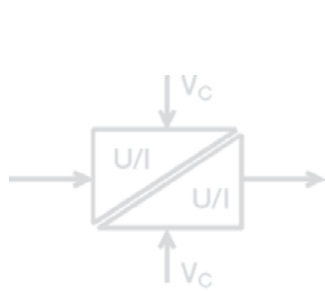

VCC DC

0 ... 10 V / 0 ... 20 mA

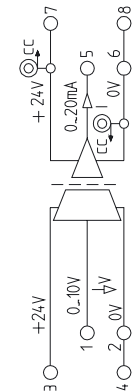

VCC DC

0 ... 10 V / 4 ... 20 mA

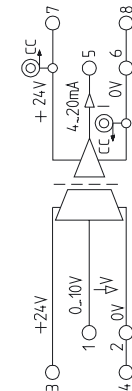

VCC DC

0 ... 10 V / 0 ... 10 V

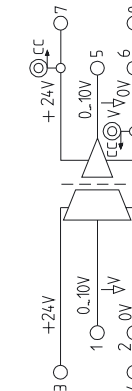

Ordering data

Screw connection	Type	Cat. No.
Tension clamp connection	WAS4 VCC DC	8447050000
Input/output	WAZ4 VCC DC	8447080000

Type	Cat. No.
WAS4 VCC DC	8447050000
WAZ4 VCC DC	8447080000

Type	Cat. No.
WAS4 VCC DC	8447100000
WAZ4 VCC DC	8447110000

Type	Cat. No.
WAS4 VVC DC	8447130000
WAZ4 VVC DC	8447140000

Technical data*

Input signal	0 ... 10 V
Input voltage max.	15 V
Input resistance	500 kΩ
Output signal	0 ... 20 mA
Load resistance	≤ 500 Ω
Accuracy at Tu=23°C	± 0.2% of FS
Temperature coefficient	≤ 250 ppm / K of FS
Response time	≤ 30 ms (typ. 25 ms)
Cut-off frequency (-3 dB)	≥ 13 Hz (typ. 17 Hz)

0 ... 10 V	15 V	500 kΩ	0 ... 20 mA	≤ 500 Ω	± 0.2% of FS	≤ 250 ppm / K of FS	≤ 30 ms (typ. 25 ms)	≥ 13 Hz (typ. 17 Hz)
------------	------	--------	-------------	---------	--------------	---------------------	----------------------	----------------------

0 ... 10 V	15 V	500 kΩ	4 ... 20 mA	≤ 500 Ω	± 0.2% of FS	≤ 250 ppm / K of FS	≤ 30 ms (typ. 25 ms)	≥ 13 Hz (typ. 17 Hz)
------------	------	--------	-------------	---------	--------------	---------------------	----------------------	----------------------

0 ... 10 V	15 V	500 kΩ	0 ... 10 V	≥ 1 kΩ	± 0.2% of FS	≤ 250 ppm / K of FS	≤ 30 ms (typ. 25 ms)	≥ 13 Hz (typ. 17 Hz)
------------	------	--------	------------	--------	--------------	---------------------	----------------------	----------------------

General

Voltage supply	24 Vdc ±20% (19.2 ... 28.8 Vdc)
Power consumption input	< 11 mA at U _{in} = 10 V
Power consumption output	< 32 mA at I _{out} = 20 mA
Current carrying capacity of cross-connection	≤ 2 A
Operating temperature	0 °C ... +55 °C (mounted)
Storage temperature	-20 °C ... +85 °C
Dimensions L / H / W mm	92.4 / 112.5 / 12.5
Approvals	CE, UL, CSA

24 Vdc ±20% (19.2 ... 28.8 Vdc)	< 11 mA at U _{in} = 10 V	< 32 mA at I _{out} = 20 mA	≤ 2 A	0 °C ... +55 °C (mounted)	-20 °C ... +85 °C	92.4 / 112.5 / 12.5	CE, UL, CSA
------------------------------------	-----------------------------------	-------------------------------------	-------	---------------------------	-------------------	---------------------	-------------

24 Vdc ±20% (19.2 ... 28.8 Vdc)	< 11 mA at U _{in} = 10 V	< 32 mA at I _{out} = 20 mA	≤ 2 A	0 °C ... +55 °C (mounted)	-20 °C ... +85 °C	92.4 / 112.5 / 12.5	CE, UL, CSA
------------------------------------	-----------------------------------	-------------------------------------	-------	---------------------------	-------------------	---------------------	-------------

24 Vdc ±20% (19.2 ... 28.8 Vdc)	< 11 mA at U _{in} = 10 V	< 20 mA at I _{out} = 10 mA	≤ 2 A	0 °C ... +55 °C (mounted)	-20 °C ... +85 °C	92.4 / 112.5 / 12.5	CE, UL, CSA
------------------------------------	-----------------------------------	-------------------------------------	-------	---------------------------	-------------------	---------------------	-------------

Coordination of insulation according to EN 50178, 04/98

Rated voltage	300 V
Rated surge voltage	4 kV
Overvoltage category	III
Contamination class	2
Clearance and creepage distance	≥ 3 mm
Isolation voltage, voltage strength	4 kV _{eff} / 1 min
Standards/specifications	EN 50178
EMC standards	EN 50081, EN 50082, EN 55011
Dimensions and accessories see	Page 298 + 308

300 V	4 kV	III	2	≥ 3 mm	4 kV _{eff} / 1 min	EN 50178	EN 50081, EN 50082, EN 55011	Page 298 + 308
-------	------	-----	---	--------	-----------------------------	----------	------------------------------	----------------

300 V	4 kV	III	2	≥ 3 mm	4 kV _{eff} / 1 min	EN 50178	EN 50081, EN 50082, EN 55011	Page 298 + 308
-------	------	-----	---	--------	-----------------------------	----------	------------------------------	----------------

300 V	4 kV	III	2	≥ 3 mm	4 kV _{eff} / 1 min	EN 50178	EN 50081, EN 50082, EN 55011	Page 298 + 308
-------	------	-----	---	--------	-----------------------------	----------	------------------------------	----------------

*T_U = 23 °C single module

DC/DC Signal Conditioners

WAVEANALOG DC/DC

- 3-way-isolation
- analogue signal conditioning
- indication LED
- cross-connectable voltage supply via cross-connectors

Approvals:



Block diagram

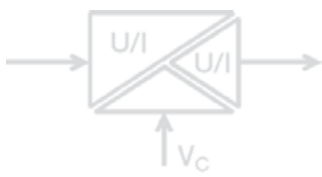

CCC

0 ... 20 mA / 0 ... 20 mA



CCC

0 ... 20 mA / 4 ... 20 mA



CVC

0 ... 20 mA / 0 ... 10 V

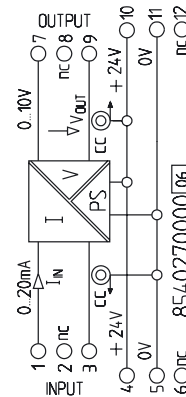
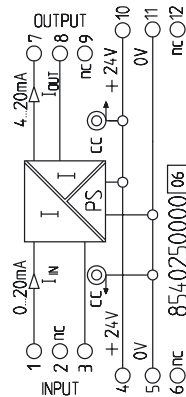
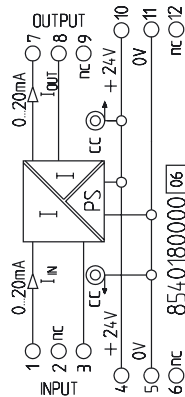

Ordering data
Screw connection
Tension clamp connection
Input/output

Type	Cat. No.
WAS5 CCC	8540180000*
WAZ5 CCC	8540190000*
0 ... 20 mA / 0 ... 20 mA	

Type	Cat. No.
WAS5 CCC	8540250000
WAZ5 CCC	8540260000
0 ... 20 mA / 4 ... 20 mA	

Type	Cat. No.
WAS5 CVC	8540270000
WAZ5 CVC	8540280000
0 ... 20 mA / 0 ... 10 V	

Technical data**
Input signal
Input current max
Input resistance
Output signal
Load resistance
Accuracy at Tu=23 °C
Temperature coefficient
Response time
Cut-off frequency (-3 dB)

0 ... 20 mA
25 mA
≤ 110 Ω
0 ... 20 mA
≤ 600 Ω
0.2%
± 250 ppm / K
≤ 45 ms
10 Hz

0 ... 20 mA
25 mA
≤ 110 Ω
4 ... 20 mA
≤ 600 Ω
0.2%
± 250 ppm / K
≤ 45 ms
10 Hz

0 ... 20 mA
25 mA
≤ 110 Ω
0 ... 10 V
≥ 1 kΩ
0.2%
± 250 ppm / K
≤ 45 ms
10 Hz

General
Voltage supply
Power consumption
Current carrying capacity of cross-connection
Operating temperature
Storage temperature
Dimensions L / H / W mm
Approvals

24 Vdc ±25%
(18 Vdc ... 24 Vdc ... 30 Vdc)
< 1.5 W at I _{out} = 20 mA
≤ 2 A
0 °C ... +55 °C
when mounted horizontally
-20 °C ... +85 °C
92.4 / 112.5 / 17.5
CE, cUL

24 Vdc ±25%
(18 Vdc ... 24 Vdc ... 30 Vdc)
< 1.5 W at I _{out} = 20 mA
≤ 2 A
0 °C ... +55 °C
when mounted horizontally
-20 °C ... +85 °C
92.4 / 112.5 / 17.5
CE, cUL

24 Vdc ±25%
(18 Vdc ... 24 Vdc ... 30 Vdc)
< 1.3 W at I _{out} = 5 mA
≤ 2 A
0 °C ... +55 °C
when mounted horizontally
-20 °C ... +85 °C
92.4 / 112.5 / 17.5
CE, cUL

Coordination of insulation according to EN 50178, 04/98
Rated voltage
Rated surge voltage
Overvoltage category
Contamination class
Clearance and creepage distance
Coupling capacity
Input / output to supply
Isolation voltage, voltage strength
Input/output to mounting rail
Standards/specifications
EMC standards
Dimensions and accessories see

300 V
4 kV
III
2
≥ 3 mm
1 nF
4 kV _{eff} / 1 min
EN 50178
EN 50081, EN 50082, EN 55011
Page 298 + 308

300 V
4 kV
III
2
≥ 3 mm
1 nF
4 kV _{eff} / 1 min
EN 50178
EN 50081, EN 50082, EN 55011
Page 298 + 308

300 V
4 kV
III
2
≥ 3 mm
1 nF
4 kV _{eff} / 1 min
EN 50178
EN 50081, EN 50082, EN 55011
Page 298 + 308

** Tu = 23 °C single module
* Input/output 4 ... 20 mA/4 ... 20 mA possible

DC/DC Signal Conditioners

WAVEANALOG DC/DC

- 3-way-isolation
- analogue signal conditioning
- indication LED
- cross-connectable voltage supply via cross-connectors

Approvals:



Block diagram

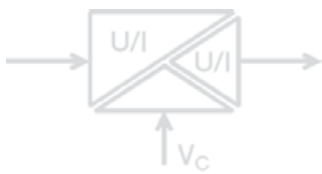

CCC

4 ... 20 mA / 0 ... 20 mA

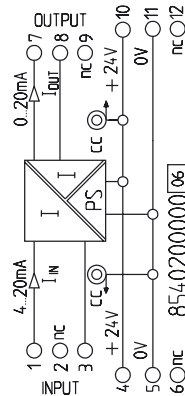

CVC

4 ... 20 mA / 0 ... 10 V

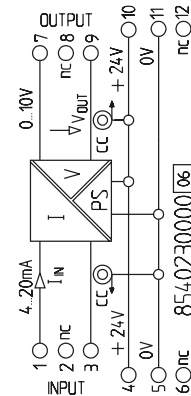

Ordering data
Screw connection
Tension clamp connection
Input/output

Technical data
Input signal
Input signal max
Input resistance
Output signal
Load resistance
Accuracy at $T_u=23\text{ }^\circ\text{C}$
Temperature coefficient
Response time
Cut-off frequency (-3 dB)

General*
Voltage supply
Power consumption
Current carrying capacity of cross-connection
Operating temperature
Storage temperature
Dimensions L / H / W mm
Approvals

Coordination of insulation according to EN 50178, 04/98
Rated voltage
Rated surge voltage
Overvoltage category
Contamination class
Clearance and creepage distance
Coupling capacity
Input / output to supply
Isolation voltage, voltage strength
Input/output to mounting rail
Standards/specifications
EMC standards

Dimensions and accessories see

Type	Cat. No.
WAS5 CCC	8540200000
WAZ5 CCC	8540210000

4 ... 20 mA
25 mA
$\leq 110\ \Omega$
0 ... 20 mA
$\leq 600\ \Omega$
0.2%
$\pm 250\ \text{ppm} / \text{K}$
$\leq 45\ \text{ms}$
10 Hz

24 Vdc $\pm 25\%$ (18 Vdc ... 24 Vdc ... 30 Vdc)
$< 1.5\ \text{W}$ at $I_{out} = 20\ \text{mA}$
$\leq 2\ \text{A}$
0 $^\circ\text{C}$... +55 $^\circ\text{C}$ when mounted horizontally
-20 $^\circ\text{C}$... +85 $^\circ\text{C}$
92.4 / 112.5 / 17.5
CE, cUL

300 V
4 kV
III
2
$\geq 3\ \text{mm}$
1 nF
4 kV _{eff} / 1 min
EN 50178
EN 50081, EN 50082, EN 55011

Page 298 + 308

Type	Cat. No.
WAS5 CVC	8540230000
WAZ5 CVC	8540240000

4 ... 20 mA
25 mA
$\leq 110\ \Omega$
0 ... 10 V
$\geq 1\ \text{k}\Omega$
0.2%
$\pm 250\ \text{ppm} / \text{K}$
$\leq 45\ \text{ms}$
10 Hz

24 Vdc $\pm 25\%$ (18 Vdc ... 24 Vdc ... 30 Vdc)
$< 1.3\ \text{W}$ at $I_{out} = 5\ \text{mA}$
$\leq 2\ \text{A}$
0 $^\circ\text{C}$... +55 $^\circ\text{C}$ when mounted horizontally
-20 $^\circ\text{C}$... +85 $^\circ\text{C}$
92.4 / 112.5 / 17.5
CE, cUL

300 V
4 kV
III
2
$\geq 3\ \text{mm}$
1 nF
4 kV _{eff} / 1 min
EN 50178
EN 50081, EN 50082, EN 55011

Page 298 + 308

* $T_u = 23\text{ }^\circ\text{C}$ single module

DC/DC Signal Conditioners

WAVEANALOG DC/DC

- 3-way-isolation
- analogue signal conditioning
- indication LED
- cross-connectable voltage supply via cross-connectors

Approvals:



Block diagram

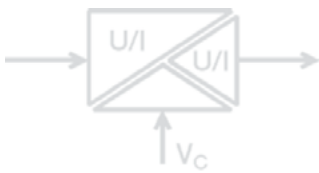

VCC
0 ... 10 V / 0 ... 20 mA



VCC
0 ... 10 V / 4 ... 20 mA



VVC
0 ... 10 V / 0 ... 10 V

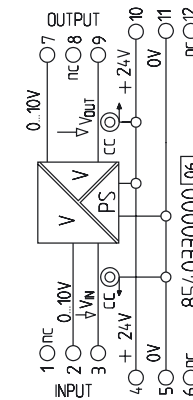
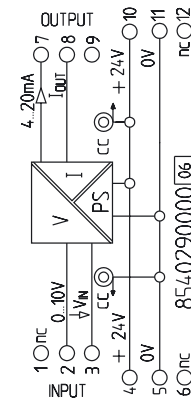
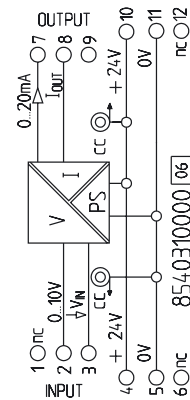

Ordering data

Screw connection	WAS5 VCC	8540310000
Tension clamp connection	WAZ5 VCC	8540320000
Input/output	0 ... 10 V / 0 ... 20 mA	

Type	Cat. No.
WAS5 VCC	8540310000
WAZ5 VCC	8540320000
Input/output	0 ... 10 V / 0 ... 20 mA

Type	Cat. No.
WAS5 VCC	8540290000
WAZ5 VCC	8540300000
Input/output	0 ... 10 V / 4 ... 20 mA

Type	Cat. No.
WAS5 VVC	8540330000
WAZ5 VVC	8540340000
Input/output	0 ... 10 V / 0 ... 10 V

Technical data*

Input signal	0 ... 10 V
Input voltage max.	15 V
Input resistance	typ. 100 kΩ
Output signal	0 ... 20 mA
Load resistance	≤ 600 Ω
Accuracy at Tu=23 °C	0.2%
Temperature coefficient	± 250 ppm / K
Response time	≤ 45 ms
Cut-off frequency (-3 dB)	10 Hz

0 ... 10 V	15 V	typ. 100 kΩ	0 ... 20 mA	≤ 600 Ω	0.2%	± 250 ppm / K	≤ 45 ms	10 Hz
------------	------	-------------	-------------	---------	------	---------------	---------	-------

0 ... 10 V	15 V	typ. 100 kΩ	4 ... 20 mA	≤ 600 Ω	0.2%	± 250 ppm / K	≤ 45 ms	10 Hz
------------	------	-------------	-------------	---------	------	---------------	---------	-------

0 ... 10 V	15 V	typ. 100 kΩ	0 ... 10 V	≥ 1 kΩ	0.2%	± 250 ppm / K	≤ 45 ms	10 Hz
------------	------	-------------	------------	--------	------	---------------	---------	-------

General

Voltage supply	24 Vdc ±25% (18 Vdc ... 24 Vdc ... 30 Vdc)
Power consumption	< 1.5 W at I _{out} = 20 mA
Current carrying capacity of cross-connection	≤ 2 A
Operating temperature	0 °C ... +55 °C when mounted horizontally
Storage temperature	-20 °C ... +85 °C
Dimensions L / H / W mm	92.4 / 112.5 / 17.5
Approvals	CE, cUL

24 Vdc ±25% (18 Vdc ... 24 Vdc ... 30 Vdc)	< 1.5 W at I _{out} = 20 mA	≤ 2 A	0 °C ... +55 °C when mounted horizontally	-20 °C ... +85 °C	92.4 / 112.5 / 17.5	CE, cUL
--	-------------------------------------	-------	--	-------------------	---------------------	---------

24 Vdc ±25% (18 Vdc ... 24 Vdc ... 30 Vdc)	< 1.5 W at I _{out} = 20 mA	≤ 2 A	0 °C ... +55 °C when mounted horizontally	-20 °C ... +85 °C	92.4 / 112.5 / 17.5	CE, cUL
--	-------------------------------------	-------	--	-------------------	---------------------	---------

24 Vdc ±25% (18 Vdc ... 24 Vdc ... 30 Vdc)	< 1.3 W at I _{out} = 5 mA	≤ 2 A	0 °C ... +55 °C when mounted horizontally	-20 °C ... +85 °C	92.4 / 112.5 / 17.5	CE, cUL
--	------------------------------------	-------	--	-------------------	---------------------	---------

Coordination of insulation according to EN 50178, 04/98

Rated voltage	300 V
Rated surge voltage	4 kV
Overvoltage category	III
Contamination class	2
Clearance and creepage distance	≥ 3 mm
Coupling capacity	1 nF
Input / output to supply	1 nF
Isolation voltage, voltage strength	4 kV _{eff} / 1 min
Input/output to mounting rail	4 kV _{eff} / 1 min
Standards/specifications	EN 50178
EMC standards	EN 50081, EN 50082, EN 55011

300 V	4 kV	III	2	≥ 3 mm	1 nF	1 nF	4 kV _{eff} / 1 min	4 kV _{eff} / 1 min	EN 50178	EN 50081, EN 50082, EN 55011
-------	------	-----	---	--------	------	------	-----------------------------	-----------------------------	----------	---------------------------------

300 V	4 kV	III	2	≥ 3 mm	1 nF	1 nF	4 kV _{eff} / 1 min	4 kV _{eff} / 1 min	EN 50178	EN 50081, EN 50082, EN 55011
-------	------	-----	---	--------	------	------	-----------------------------	-----------------------------	----------	---------------------------------

300 V	4 kV	III	2	≥ 3 mm	1 nF	1 nF	4 kV _{eff} / 1 min	4 kV _{eff} / 1 min	EN 50178	EN 50081, EN 50082, EN 55011
-------	------	-----	---	--------	------	------	-----------------------------	-----------------------------	----------	---------------------------------

Dimensions and accessories see	Page 298 + 308
--------------------------------	----------------

Page 298 + 308

Page 298 + 308

Page 298 + 308

*T_U = 23 °C single module

DC/DC Signal Conditioners

WAVEANALOG DC/DC 20 kHz

- 3-way-isolation
- transmission frequency 20 kHz
- analogue signal conditioning
- cross-connectable voltage supply via cross-connectors

Approvals:



Block diagram

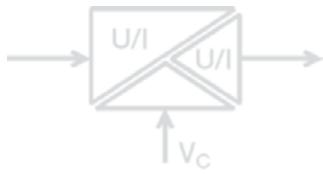

CCC HF

0 ... 20 mA / 0 ... 20 mA



CCC HF

0 ... 20 mA / 4 ... 20 mA



CVC HF

0 ... 20 mA / 0 ... 10 V

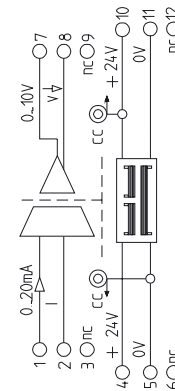
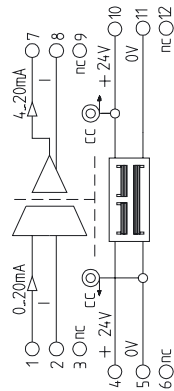
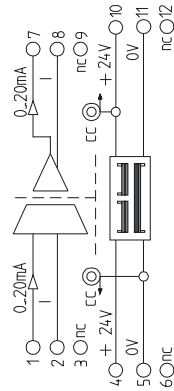

Ordering data

Screw connection	Type	Cat. No.
Tension clamp connection	WAS5 CCC HF	8447160000*
Input/output	WAZ5 CCC HF	8447170000*

Type	Cat. No.
WAS5 CCC HF	8447160000*
WAZ5 CCC HF	8447170000*

Type	Cat. No.
WAS5 CCC HF	8447190000
WAZ5 CCC HF	8447200000

Type	Cat. No.
WAS5 CVC HF	8447220000
WAZ5 CVC HF	8447230000

Technical data**

Input signal	0 ... 20 mA
Input current max	50 mA
Input resistance	50 Ω
Output signal	0 ... 20 mA
Load resistance	≤ 500 Ω
Accuracy at Tu=23 °C	< 0.2% of FS
Temperature coefficient	≤ 250 ppm / K of FS
Response time	≤ 40 μs (typ. 30 μs)
Cut-off frequency (-3 dB)	≥ 15 kHz (typ. 20 kHz)

0 ... 20 mA	50 mA	50 Ω	0 ... 20 mA	≤ 500 Ω	< 0.2% of FS	≤ 250 ppm / K of FS	≤ 40 μs (typ. 30 μs)	≥ 15 kHz (typ. 20 kHz)
-------------	-------	------	-------------	---------	--------------	---------------------	----------------------	------------------------

0 ... 20 mA	50 mA	50 Ω	4 ... 20 mA	≤ 500 Ω	< 0.2% of FS	≤ 250 ppm / K of FS	≤ 40 μs (typ. 30 μs)	≥ 15 kHz (typ. 20 kHz)
-------------	-------	------	-------------	---------	--------------	---------------------	----------------------	------------------------

0 ... 20 mA	50 mA	50 Ω	0 ... 10 V	≥ 2 kΩ	< 0.2% of FS	≤ 250 ppm / K of FS	≤ 40 μs (typ. 30 μs)	≥ 15 kHz (typ. 20 kHz)
-------------	-------	------	------------	--------	--------------	---------------------	----------------------	------------------------

General

Voltage supply	24 Vdc ±25% (18 ... 30 Vdc)
Power consumption	< 1.5 W at I _{out} = 20 mA
Current carrying capacity of cross-connection	≤ 2 A
Operating temperature	0 °C ... +55 °C
Storage temperature	-20 °C ... +85 °C
Dimensions L / H / W mm	92.4 / 112.5 / 17.5
Approvals	CE, UL, CSA

24 Vdc ±25% (18 ... 30 Vdc)	< 1.5 W at I _{out} = 20 mA	≤ 2 A	0 °C ... +55 °C	-20 °C ... +85 °C	92.4 / 112.5 / 17.5	CE, UL, CSA
-----------------------------	-------------------------------------	-------	-----------------	-------------------	---------------------	-------------

24 Vdc ±25% (18 ... 30 Vdc)	< 1.5 W at I _{out} = 20 mA	≤ 2 A	0 °C ... +55 °C	-20 °C ... +85 °C	92.4 / 112.5 / 17.5	CE, UL, CSA
-----------------------------	-------------------------------------	-------	-----------------	-------------------	---------------------	-------------

24 Vdc ±25% (18 ... 30 Vdc)	< 1.3 W at I _{out} = 5 mA	≤ 2 A	0 °C ... +55 °C	-20 °C ... +85 °C	92.4 / 112.5 / 17.5	CE, UL, CSA
-----------------------------	------------------------------------	-------	-----------------	-------------------	---------------------	-------------

Coordination of insulation according to EN 50178, 04/98

Rated voltage	300 V
Rated surge voltage	4 kV
Overtoltage category	III
Contamination class	2
Clearance and creepage distance	≥ 3 mm
Coupling capacity	
Input / output to supply	1 nF
Isolation voltage, voltage strength	
Input/output to mounting rail	4 kV _{eff} / 1 min

300 V	4 kV	III	2	≥ 3 mm	1 nF	4 kV _{eff} / 1 min
-------	------	-----	---	--------	------	-----------------------------

300 V	4 kV	III	2	≥ 3 mm	1 nF	4 kV _{eff} / 1 min
-------	------	-----	---	--------	------	-----------------------------

300 V	4 kV	III	2	≥ 3 mm	1 nF	4 kV _{eff} / 1 min
-------	------	-----	---	--------	------	-----------------------------

Standards/specifications

EMC standards	EN 50178 EN 50081, EN 50082, EN 55011
---------------	---

EN 50178 EN 50081, EN 50082, EN 55011

EN 50178 EN 50081, EN 50082, EN 55011

EN 50178 EN 50081, EN 50082, EN 55011

Dimensions and accessories see

Page 298 + 308

Page 298 + 308

Page 298 + 308

**T_U = 23 °C single module

* Input/output 4 ... 20 mA/4 ... 20 mA possible

DC/DC Signal Conditioners

WAVEANALOG DC/DC 20 kHz

- 3-way-isolation
- transmission frequency 20 kHz
- analogue signal conditioning
- cross-connectable voltage supply via cross-connectors

Approvals:



Block diagram

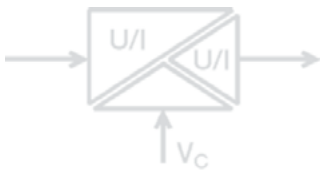

CCC HF

4 ... 20 mA / 0 ... 20 mA

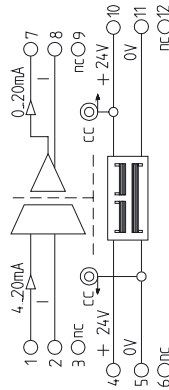

CVC HF

4 ... 20 mA / 0 ... 10 V

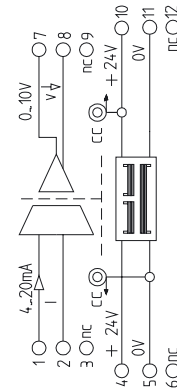

Ordering data
Screw connection
Tension clamp connection
Input/output

Technical data*
Input signal
Input current max
Input resistance
Output signal
Load resistance
Accuracy at Tu=23 °C
Temperature coefficient
Response time
Cut-off frequency (-3 dB)

General
Voltage supply
Power consumption
Current carrying capacity of cross-connection
Operating temperature
Storage temperature
Dimensions L / H / W mm
Approvals

Coordination of insulation according to EN 50178, 04/98
Rated voltage
Rated surge voltage
Overvoltage category
Contamination class
Clearance and creepage distance
Coupling capacity
Input / output to supply
Isolation voltage, voltage strength
Input/output to mounting rail
Standards/specifications
EMC standards
Dimensions and accessories see

Type	Cat. No.
WAS5 CCC HF	8447250000
WAZ5 CCC HF	8447260000

4 ... 20 mA
50 mA
50 Ω
0 ... 20 mA
≤ 500 Ω
< 0.2% of FS
≤ 250 ppm / K of FS
≤ 40 μs (typ. 30 μs)
≥ 15 kHz (typ. 20 kHz)

24 Vdc ±25% (18 ... 30 Vdc)
< 1.5 W at I _{out} = 20 mA
≤ 2 A
0 °C ... +55 °C
-20 °C ... +85 °C
92.4 / 112.5 / 17.5
CE, UL, CSA

300 V
4 kV
III
2
≥ 3 mm
1 nF
4 kV _{eff} / 1 min
EN 50178
EN 50081, EN 50082, EN 55011
Page 298 + 308

Type	Cat. No.
WAS5 CVC HF	8447280000
WAZ5 CVC HF	8447290000

4 ... 20 mA
50 mA
50 Ω
0 ... 10 V
≥ 2 kΩ
< 0.2% of FS
≤ 250 ppm / K of FS
≤ 40 μs (typ. 30 μs)
≥ 15 kHz (typ. 20 kHz)

24 Vdc ±25% (18 ... 30 Vdc)
< 1.3 W at I _{out} = 5 mA
≤ 2 A
0 °C ... +55 °C
-20 °C ... +85 °C
92.4 / 112.5 / 17.5
CE, UL, CSA

300 V
4 kV
III
2
≥ 3 mm
1 nF
4 kV _{eff} / 1 min
EN 50178
EN 50081, EN 50082, EN 55011
Page 298 + 308

*T_U = 23 °C single module

DC/DC Signal Conditioners

WAVEANALOG DC/DC 20 kHz

- 3-way-isolation
- transmission frequency 20 kHz
- analogue signal conditioning
- cross-connectable voltage supply via cross-connectors

Approvals:



Block diagram

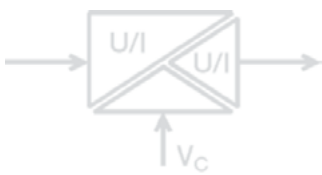

VCC HF

0 ... 10 V / 0 ... 20 mA

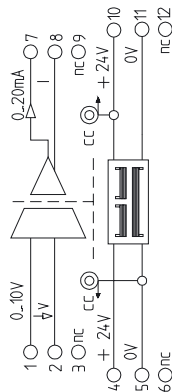

VCC HF

0 ... 10 V / 4 ... 20 mA

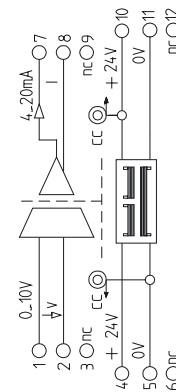

Ordering data
Screw connection
Tension clamp connection
Input/output

Technical data*
Input signal
Input voltage max.
Input resistance
Output signal
Load resistance
Accuracy at Tu=23 °C
Temperature coefficient
Response time
Cut-off frequency (-3 dB)

General
Voltage supply
Power consumption
Current carrying capacity of cross-connection
Operating temperature
Storage temperature
Dimensions L / H / W mm
Approvals

Coordination of insulation according to EN 50178, 04/98
Rated voltage
Rated surge voltage
Overvoltage category
Contamination class
Clearance and creepage distance
Coupling capacity
Input / output to supply
Isolation voltage, voltage strength
Input/output to mounting rail
Standards/specifications
EMC standards
Dimensions and accessories see

Type	Cat. No.
WAS5 VCC HF	8447310000
WAZ5 VCC HF	8447320000
0 ... 10 V / 0 ... 20 mA	

0 ... 10 V
15 V
500 kΩ
0 ... 20 mA
≤ 500 Ω
± 0.2% of FS
≤ 250 ppm / K of FS
≤ 40 μs (typ. 30 μs)
≥ 15 kHz (typ. 20 kHz)

24 Vdc ±25% (18 ... 30 Vdc)
< 1.5 W at I _{out} = 20 mA
≤ 2 A
0 °C ... +55 °C
-20 °C ... +85 °C
92.4 / 112.5 / 17.5
CE, UL, CSA

300 V
4 kV
III
2
≥ 3 mm
1 nF
4 kV _{eff} / 1 min
EN 50178
EN 50081, EN 50082, EN 55011
Page 298 + 308

Type	Cat. No.
WAS5 VCC HF	8447340000
WAZ5 VCC HF	8447350000
0 ... 10 V / 4 ... 20 mA	

0 ... 10 V
15 V
500 kΩ
4 ... 20 mA
≤ 500 Ω
± 0.2% of FS
≤ 250 ppm / K of FS
≤ 40 μs (typ. 30 μs)
≥ 15 kHz (typ. 20 kHz)

24 Vdc ±25% (18 ... 30 Vdc)
< 1.5 W at I _{out} = 20 mA
≤ 2 A
0 °C ... +55 °C
-20 °C ... +85 °C
92.4 / 112.5 / 17.5
CE, UL, CSA

300 V
4 kV
III
2
≥ 3 mm
1 nF
4 kV _{eff} / 1 min
EN 50178
EN 50081, EN 50082, EN 55011
Page 298 + 308

*Tu = 23 °C single module

DC/DC Signal Conditioners

WAVEANALOG DC/DC 20 kHz

- 3-way-isolation
- transmission frequency 20 kHz
- analogue signal conditioning
- cross-connectable voltage supply via cross-connectors

VVC HF

0 ... 10 V / 0 ... 10 V



Approvals:



VVC HF

-10 ... +10 V / -10 ... +10 V



Approvals:



Block diagram

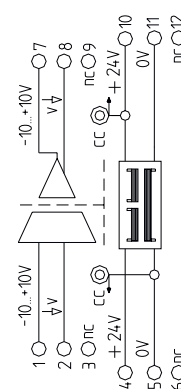
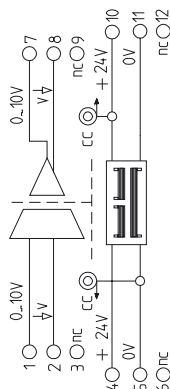
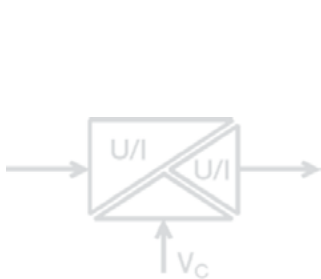

Ordering data
Screw connection
Tension clamp connection
Input/output

Type	Cat. No.
WAS5 VVC HF	8447370000
WAZ5 VVC HF	8447380000
0 ... 10 V / 0 ... 10 V	

Type	Cat. No.
WAS5 VVC HF	8561610000
WAZ5 VVC HF	8587000000
±10 V / ±10 V	

Technical data*	
Input signal	0 ... 10 V
Input voltage max.	15 V
Input resistance	500 kΩ
Output signal	0 ... 10 V
Load resistance	≥ 2 kΩ
Accuracy at Tu=23 °C	± 0.2% of FS
Temperature coefficient	≤ 250 ppm / K of FS
Response time	≤ 40 μs (typ. 30 μs)
Cut-off frequency (-3 dB)	≥ 15 kHz (typ. 20 kHz)

General	
Voltage supply	24 Vdc ±25% (18 ... 30 Vdc)
Power consumption	< 1.3 W at I _{out} = 5 mA
Current carrying capacity of cross-connection	≤ 2 A
Operating temperature	0 °C ... +55 °C
Storage temperature	-20 °C ... +85 °C
Dimensions L / H / W mm	92.4 / 112.5 / 17.5
Approvals	CE, UL, CSA

Coordination of insulation according to EN 50178, 04/98	
Rated voltage	300 V
Rated surge voltage	4 kV
Overvoltage category	III
Contamination class	2
Clearance and creepage distance	≥ 3 mm
Coupling capacity	
Input / output to supply	1 nF
Isolation voltage, voltage strength	
Input/output to mounting rail	4 kV _{eff} / 1 min
Standards/specifications	EN 50178
EMC standards	EN 50081, EN 50082, EN 55011
Dimensions and accessories see	Page 298 + 308

*T_U = 23 °C single module

DC/DC Signal Conditioners (Configurable)

WAVEANALOG PRO DC/DC

- universally adjustable via DIP switch
- adjustment help via Internet
- 3-way-isolation
- voltage supply from 20 - 230 V ac/dc
- low power loss
- adjustable transmission frequency
- indication LED

Approvals:



Block diagram

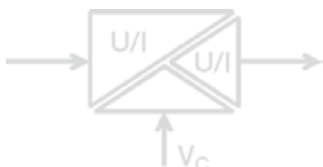

PRO DC/DC

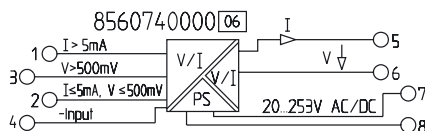

Ordering data

Screw connection	WAS4 PRO DC/DC	8560740000
Tension clamp connection	WAZ4 PRO DC/DC	8560750000
Input/output	configurable	

Technical data*

Input (adjustable)

Voltage uni-/bipolar adjustable
Voltage calibrated ranges

Current uni-/bipolar adjustable
Current calibrated ranges

Input resistance
at current input range < 5 mA / > 5 mA
at voltage input

Input capacity
at current input

Voltage input range < 500 mV / > 500 mV
Overload capacity
at current input range < 5 mA / > 5 mA
Voltage input range < 500 mV / > 500 mV

Output (adjustable)

Voltage uni-/bipolar adjustable
Voltage calibrated ranges

Current uni-/bipolar adjustable
Current calibrated ranges

Offset

Load
at output current
at output voltage

Offset
Residual ripple
Adjustment zero pot.

Adjustment span pot.
Gain error

Temperature coefficient
Cut-off frequency

General

Voltage supply
Power consumption

Frequency range
Operating temperature
Storage temperature

Factory setting
Dimensions L/H/B mm

Weight
Approvals

Coordination of insulation according to EN 50178, 04/98

Rated voltage
Rated surge voltage

Overvoltage category
Contamination class

Test voltage

Standards/specifications
EMC standards

Type

Type	Cat. No.
WAS4 PRO DC/DC	8560740000
WAZ4 PRO DC/DC	8560750000
configurable	

20 mV ... 200 V
0 ... ±60 mV, 0 ... ±100 mV, 0 ... ±150 mV, 0 ... ±300 mV,
0 ... ±500 mV, 0 ... ±1V, 0 ... ±5V, 0 ... ±10 V, 0 ... ±100 V

0.1 mA ... 100 mA
0 ... ±0.3 mA, 0 ... ±1 mA, 0 ... ±5 mA, 0 ... ±16 mA,
0 ... 20 mA, 0 ... 50 mA

approx. 100 Ω / approx. 5 Ω
approx. 1 MΩ

approx. 1 nF
approx. 1 nF / approx. 500 pF

< 75 mA / < 300 mA
max. < 20 mA / < 3 mA continuous current

0 ... 10 V
0 ... ±10 V, 2 ... 10 V, 0 ... ±5 V, 1 ... 5 V

0 ... 20 mV
0 ... ±20 mA, 4 ... 20 mA

-100%, -50%, 0%, 50%, 100% of measuring span of the
chosen output range

< 12 V (600 Ω at 20 mA)
< 10 mA (1 KΩ at 10 V)

20 µA and. 10 mV
< 10 mVeff

+25% measuring span of the chosen output range
0.33 ... 3.30 x end value of chosen input range

< 0.1% of FS
< 60 ppm/K of FS

> 10 kHz, < 10 Hz switch

20 ... 230 V ac/dc +10%
approx. 1 W

48 ... 62 Hz
-10 °C ... +70 °C

-40 °C ... +85 °C
0 ... 10 V / 0 ... 10 V 10 Hz

92.4 / 112.5 / 12.5
approx. 100 g

CE, cUL, GL

600 V
5 kV, 1.2/50 us, acc. to IEC 255-4

III
2
4 KVeff input against output against auxiliary power

EN 50178
DIN EN 61326, EN 61326/A1, EN 50081-2, EN 61000-6-2

Adjustment help WAVEtool

The service tool enables quick and uncomplicated configuration of WAVEANALOG PRO. Download from Internet: <http://www.weidmueller.de> → Products → Downloads (see page 192)

Switch position/setting options

Input	Switch							
	S1				S2			
Input range	1	2	3	4	1	2	3	4
0 ... ±60 mV								■
0 ... ±100 mV	■							■
0 ... ±150 mV		■						■
0 ... ±300 mV	■	■						■
0 ... ±500 mV			■					■
0 ... ±1 V	■	■			■	■		■
0 ... ±5 V		■	■		■	■		■
0 ... ±10 V	■	■	■		■	■		■
0 ... ±100 V				■			■	■
0 ... ±~0.3 mA	■	■	■		■	■		■
0 ... ±1 mA		■	■		■	■		■
0 ... ±5 mA	■	■	■		■	■		■
0 ... ±10 mA			■		■	■		■
0 ... ±20 mA	■	■	■		■	■		■
0 ... ±50 mA		■	■		■	■		■
0 ... ±20 mA*	■	■	■		■	■		■

*Offset conversion not calibrated

Switch S2		4
calibrated ranges		■
Span pot. activated: input range x 0.33 ... x 3.30		

Output	Switch				
	S1		S3		
Output range	5	6	7	1	2
0 ... ±10 V				■	■
2 ... 10 V	■				
0 ... ±5 V		■		■	■
1 ... 5 V	■	■		■	■
0 ... ±20 mA			■		
4 ... 20 mA		■	■		

Offset	Switch			
	S1		S2	
(in % of output voltage)	8	9	10	5
0 %				■
-100 %	■			■
-50 %		■		■
+50 %	■	■		■
+100 %			■	■

Zero pot. activated: additional ±25 %

Switch S3		3
Bandwidth 10 kHz		
Bandwidth 10 Hz		■

Set range can be documented on side of housing.

■ = on
= off

Dimensions and accessories see page 298 + 308

*T_U = 23 °C single module

RTD Signal Conditioners

WAVEANALOG RTD

- 2-wire technology
- configurable temperature range
-200 °C ... +800 °C
- Configurable output current range
0 ... 20 mA / 4 ... 20 mA
- cross-connectable voltage supply
via cross-connectors

Approvals:



Block diagram

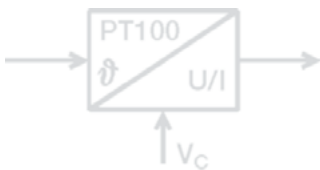

PT100/2

0(4) ... 20 mA



PT100/2

0 ... 10 V



Switch position/setting options

Tmin	1	2	3	Span	4	5	6
0 °C	■	■	■	40 ... 50 °C	■	■	■
-10 °C	■	■	■	50 ... 75 °C	■	■	■
-20 °C	■	■	■	75 ... 110 °C	■	■	■
-40 °C	■	■	■	110 ... 165 °C	■	■	■
-60 °C	■	■	■	165 ... 245 °C	■	■	■
-80 °C	■	■	■	245 ... 360 °C	■	■	■
-100 °C	■	■	■	360 ... 540 °C	■	■	■
-200 °C	■	■	■	540 ... 800 °C	■	■	■

Output ¹⁾	7
Range	7
0 ... 20 mA	■
4 ... 20 mA	■

¹⁾ only modules with current output

■ = on
= off

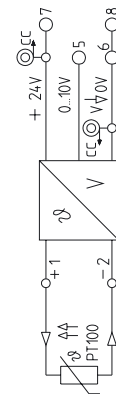
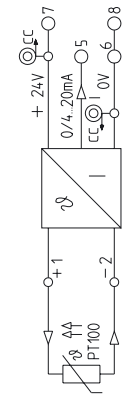

Ordering data

Screw connection	Type	Cat. No.
Tension clamp connection	WTS4 PT100/2 C	8432210000*
Input/output	WTZ4 PT100/2 C	8432220000*
	PT100/2 / 0(4) ... 20 mA	

Type	Cat. No.
WTS4 PT100/2 C	8432210000*
WTZ4 PT100/2 C	8432220000*
PT100/2 / 0(4) ... 20 mA	

Type	Cat. No.
WTS4 PT100/2 V	8432180000*
WTZ4 PT100/2 V	8432190000*
PT100/2 / 0 ... 10 V	

Technical data***

Input signal	PT100/2-wire
Temperature range	-200 ... +800 °C
Supply current	1.45 mA
Conductor resistance	
Output signal	PT100/2-wire
Load resistance	0(4) ... 20 mA
Accuracy at Tu=23 °C	≤ 500 Ω
Temperature coefficient	± 0.5% of measurement range
Measurement range ≥ 200 K	≤ 200 ppm / °C (typ. 80 ppm / °C)
100 K ≤ measurement range < 200 K	≤ 250 ppm / °C (typ. 100 ppm / °C)
40 K ≤ measurement range < 100 K	≤ 500 ppm / °C

Input signal	PT100/2-wire
Temperature range	-200 ... +800 °C
Supply current	1.45 mA
Conductor resistance	
Output signal	PT100/2-wire
Load resistance	0 ... 10 V
Accuracy at Tu=23 °C	≥ 1 kΩ
Temperature coefficient	± 0.5% of measurement range
Measurement range ≥ 200 K	≤ 200 ppm / °C (typ. 80 ppm / °C)
100 K ≤ measurement range < 200 K	≤ 250 ppm / °C (typ. 100 ppm / °C)
40 K ≤ measurement range < 100 K	≤ 500 ppm / °C

General

Voltage supply	24 Vdc ±20% (19.2 ... 28.8 Vdc)
Power consumption	< 48 mA at I _{out} = 20 mA
Current carrying capacity of cross-connection	≤ 2 A
Operating temperature	0 °C ... +55 °C
Storage temperature	-20 °C ... +85 °C
Standards/specifications	EN 50178, IEC 751
EMC standards	EN 50081, EN 50082, EN 55011
Dimensions L / H / W mm	92.4 / 112.5 / 12.5
Approvals	CE, UL, CSA
Dimensions and accessories see	Page 298 + 308

Voltage supply	24 Vdc ±20% (19.2 ... 28.8 Vdc)
Power consumption	< 38 mA at I _{out} = 10 mA
Current carrying capacity of cross-connection	≤ 2 A
Operating temperature	0 °C ... +55 °C
Storage temperature	-20 °C ... +85 °C
Standards/specifications	EN 50178, IEC 751
EMC standards	EN 50081, EN 50082, EN 55011
Dimensions L / H / W mm	92.4 / 112.5 / 12.5
Approvals	CE, UL, CSA
Dimensions and accessories see	Page 298 + 308

* without balancing

*** T_U = 23 °C single module

Preconfigured modules

	Input	Output		
		0 ... 20 mA	4 ... 20 mA	0 ... 10 V
Screw connection	0 ... 100 °C	8432210001	8432210011	8432180001
	special balancing	8432219999**	8432219999**	8432189999**
Tension clamp connection	0 ... 100 °C	8432220001	8432220011	8432190001
	special balancing	8432229999**	8432229999**	8432199999**

**You must indicate the temperature range when ordering
Please indicate additional output signal of current output

Aids

- Voltage supply 24 Vdc, 50 mA
- Simulator for PT 100 or precision-resistance-decade
- Ampere-/voltmeter which can be calibrated to an accuracy of >0.1 % of the end value.

RTD Signal Conditioners

WAVEANALOG RTD

- 3-wire technology
- configurable temperature range
-200 °C ... +800 °C
- configurable output current range
0 ... 20 mA / 4 ... 20 mA
- cross-connectable voltage supply
via cross-connectors

Approvals:



Block diagram

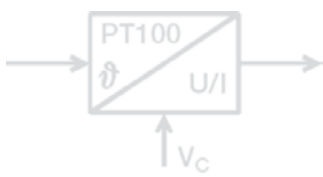

PT100/3

0(4) ... 20 mA



PT100/3

0 ... 10 V



Switch position/setting options

Tmin	1	2	3	Span	4	5	6
0 °C	■	■	■	40 ... 50 °C	■	■	■
-10 °C	■	■	■	50 ... 75 °C	■	■	■
-20 °C	■	■	■	75 ... 110 °C	■	■	■
-40 °C	■	■	■	110 ... 165 °C	■	■	■
-60 °C	■	■	■	165 ... 245 °C	■	■	■
-80 °C	■	■	■	245 ... 360 °C	■	■	■
-100 °C	■	■	■	360 ... 540 °C	■	■	■
-200 °C	■	■	■	540 ... 800 °C	■	■	■

Output¹⁾

Range	7
0 ... 20 mA	■
4 ... 20 mA	■

¹⁾ only modules with current output

■ = on
= off

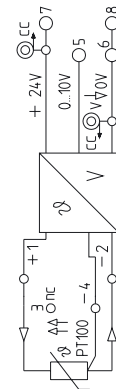
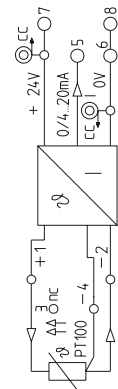

Ordering data

Screw connection	Type	Cat. No.
Tension clamp connection	WTS4 PT100/3 C	8432150000*
Input/output	WTZ4 PT100/3 C	8432160000*
	PT100/3 / 0(4) ... 20 mA	

Type	Cat. No.
WTS4 PT100/3 C	8432150000*
WTZ4 PT100/3 C	8432160000*
PT100/3 / 0(4) ... 20 mA	

Type	Cat. No.
WTS4 PT100/3 V	8432090000*
WTZ4 PT100/3 V	8432130000*
PT100/3 / 0 ... 10 V	

Technical data***

Input signal	PT100/3-wire
Temperature range	-200 ... +800 °C
Supply current	1.45 mA
Conductor resistance	≤ 50 Ω
Output signal	0(4) ... 20 mA
Load resistance	≤ 500 Ω
Accuracy at Tu=23 °C	± 0.5% of measurement range
Temperature coefficient	
Measurement range ≥ 200 K	≤ 200 ppm / °C (typ. 80 ppm / °C)
100 K ≤ measurement range < 200 K	≤ 250 ppm / °C (typ. 100 ppm / °C)
40 K ≤ measurement range < 100 K	≤ 500 ppm / °C (typ. 200 ppm / °C)

Type	Cat. No.
WTS4 PT100/3 V	8432090000*
WTZ4 PT100/3 V	8432130000*
PT100/3 / 0 ... 10 V	

Input signal	PT100/3-wire
Temperature range	-200 ... +800 °C
Supply current	1.45 mA
Conductor resistance	≤ 50 Ω
Output signal	0 ... 10 V
Load resistance	≥ 1 kΩ
Accuracy at Tu=23 °C	± 0.5% of measurement range
Temperature coefficient	
Measurement range ≥ 200 K	≤ 200 ppm / °C (typ. 80 ppm / °C)
100 K ≤ measurement range < 200 K	≤ 250 ppm / °C (typ. 100 ppm / °C)
40 K ≤ measurement range < 100 K	≤ 500 ppm / °C (typ. 200 ppm / °C)

General

Voltage supply	24 Vdc ±20% (19.2 ... 28.8 Vdc)
Power consumption	< 48 mA at I _{out} = 20 mA
Current carrying capacity of cross-connection	≤ 2 A
Operating temperature	0 °C ... +55 °C
Storage temperature	-20 °C ... +85 °C
Standards/specifications	EN 50178, IEC 751
EMC standards	EN 50081, EN 50082, EN 55011
Dimensions L / H / W mm	92.4 / 112.5 / 12.5
Approvals	CE, UL, CSA
Dimensions and accessories see	Page 298 + 308

Voltage supply	24 Vdc ±20% (19.2 ... 28.8 Vdc)
Power consumption	< 38 mA at I _{out} = 10 mA
Current carrying capacity of cross-connection	≤ 2 A
Operating temperature	0 °C ... +55 °C
Storage temperature	-20 °C ... +85 °C
Standards/specifications	EN 50178, IEC 751
EMC standards	EN 50081, EN 50082, EN 55011
Dimensions L / H / W mm	92.4 / 112.5 / 12.5
Approvals	CE, UL, CSA
Dimensions and accessories see	Page 298 + 308

Voltage supply	24 Vdc ±20% (19.2 ... 28.8 Vdc)
Power consumption	< 38 mA at I _{out} = 10 mA
Current carrying capacity of cross-connection	≤ 2 A
Operating temperature	0 °C ... +55 °C
Storage temperature	-20 °C ... +85 °C
Standards/specifications	EN 50178, IEC 751
EMC standards	EN 50081, EN 50082, EN 55011
Dimensions L / H / W mm	92.4 / 112.5 / 12.5
Approvals	CE, UL, CSA
Dimensions and accessories see	Page 298 + 308

* without balancing

*** T_U = 23 °C single module

Preconfigured modules

	Input	Output		
	0 ... 100 °C	0 ... 20 mA	4 ... 20 mA	0 ... 10 V
Screw connection		8432150001	8432150011	8432090001
	special balancing	8432159999**	8432159999**	8432099999**
Tension clamp connection	0 ... 100 °C	8432160001	8432160011	8432130001
	special balancing	8432169999**	8432169999**	8432139999**

** You must indicate the temperature range when ordering
Please indicate additional output signal of current output

Aids

- Voltage supply 24 Vdc, 50 mA
- Simulator for PT 100 or precision-resistance-decade
- Ampere-/voltmeter which can be calibrated to an accuracy of >0.1 % of the end value.

RTD Signal Conditioners

WAVEANALOG RTD

- 2-, 3- and 4-wire technology
- configurable temperature range
-200 °C ... +800 °C
- configurable output current range
0 ... 20 mA / 4 ... 20 mA
- cross-connectable voltage supply
via cross-connectors

Approvals:



Block diagram

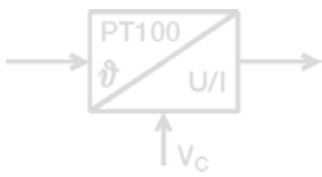

PT100/4
0(4) ... 20 mA



PT100/4
0 ... 10 V

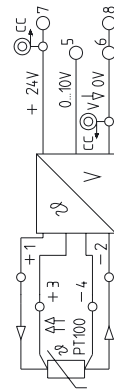
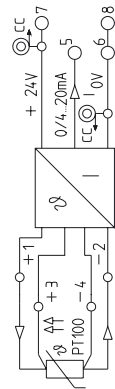

Switch position/setting options

Tmin	1	2	3	Span	4	5	6
0 °C	■	■	■	40 ... 50 °C	■	■	■
-10 °C	■	■	■	50 ... 75 °C	■	■	■
-20 °C	■	■	■	75 ... 110 °C	■	■	■
-40 °C	■	■	■	110 ... 165 °C	■	■	■
-60 °C	■	■	■	165 ... 245 °C	■	■	■
-80 °C	■	■	■	245 ... 360 °C	■	■	■
-100 °C	■	■	■	360 ... 540 °C	■	■	■
-200 °C	■	■	■	540 ... 800 °C	■	■	■

Output 1)		PT 100		
Range	7	8	9	10
0 ... 20 mA	■	■	■	■
4 ... 20 mA	■	■	■	■
		2 - wire	■	■
		3 - wire	■	■
		4 - wire	■	■

1) only modules with current output ■ = on
= off

Ordering data

Screw connection
Tension clamp connection

Technical data***

Input signal
Temperature range
Supply current
Conductor resistance

Output signal
Load resistance

Accuracy at Tu=23 °C
100 K ≤ measurement range < 600 K
Measurement range ≤ 100 K
Measurement range ≥ 600 K
Temperature coefficient
Measurement range ≥ 200 K

100 K ≤ measurement range < 200 K

40 K ≤ measurement range < 100 K

General

Voltage supply

Power consumption

Current carrying capacity of cross-connection

Operating temperature

Storage temperature

Standards/specifications

EMC standards

Dimensions L / H / W mm

Approvals

Dimensions and accessories see

* without balancing

*** Tu = 23 °C single module

Type	Cat. No.	Type	Cat. No.
WTS4 PT100/4 C	8432270000*	WTS4 PT100/4 V	432240000*
WTZ4 PT100/4 C	8432280000*	WTZ4 PT100/4 V	432250000*
PT100/4 / 0(4) ... 20 mA		PT100/4 / 0 ... 10 V	

PT100/4-wire
-200 ... +800 °C
1.45 mA
≤ 50 Ω (3- & 4-wire)

0(4) ... 20 mA
≤ 500 Ω

± 0.1% of measurement range
± 0.1 K
± 0.2% of measurement range

≤ 200 ppm / °C
(typ. 80 ppm / °C)

≤ 225 ppm / °C
(typ. 90 ppm / °C)

≤ 450 ppm / °C
(typ. 180 ppm / °C)

24 Vdc ±20%
(19.2 ... 28.8 Vdc)

< 48 mA at I_{out} = 20 mA
≤ 2 A

0 °C ... +55 °C

-20 °C ... +85 °C

EN 50178, IEC 751

EN 50081, EN 50082,
EN 55011

92.4 / 112.5 / 12.5

CE, UL, CSA

Page 298 + 308

24 Vdc ±20%
(19.2 ... 28.8 Vdc)

< 38 mA at I_{out} = 10 mA
≤ 2 A

0 °C ... +55 °C

-20 °C ... +85 °C

EN 50178, IEC 751

EN 50081, EN 50082,
EN 55011

92.4 / 112.5 / 12.5

CE, UL, CSA

Page 298 + 308

Preconfigured modules

	Input	Output		
		0 ... 20 mA	4 ... 20 mA	0 ... 10 V
Screw connection	0 ... 100 °C	8432270001	8432270011	8432240001
	special balancing	8432279999**		8432249999**
Tension clamp connection	0 ... 100 °C	8432280001	8432280011	8432250001
	special balancing	8432289999**		8432259999**

** Please indicate the temperature range and the sensor type (2-, 3- or 4-wire).

Please indicate additional output signal of current output

Aids

- Voltage supply 24 Vdc, 50 mA
- Simulator for PT 100 or precision-resistance-decade
- Ampere-/voltmeter which can be calibrated to an accuracy of >0.1 % of the end value.

RTD-Signal Isolating Transformer (Configurable)

WAVEANALOG PRO RTD

- measurement from PT 100, Ni 100, R, potentiometer
- universally adjustable via DIP switch
- 3-way-isolation
- status LED
- linearization
- cross-connectable voltage supply via cross-connectors

Approvals:



Block diagram



Ordering data

Screw connection
Tension clamp connection
Input/output

Technical data*

Input (adjustable)

PT100/2-/3-/4-wire: -200°C to 850°C
Ni100 : -60°C to +250°C
Potentiometer: min: 0...100Ω / max:0...100kΩ
Resistance: 0 ... 450Ω /

Output (adjustable)

Output voltage	0...10 V
Offset voltage	max. 0.05 V
Load resistance	≥ 1 kΩ
Output current	0/4 ... 20 mA
Offset current	max. 100 μA
Load resistance	≤ 600 Ω
Accuracy, slow/fast step response	

Step response (switchable via DIP switch)

RTD, R	typ. fast	slow
Potentiometer	< 1.2 s	< 2.2 s
Temperature coefficient	measurement range ≥ 200 K	≤ 200 ppm / °C
	100 K ≤ measurement range < 200 K	≤ 250 ppm / °C
	40 K ≤ measurement range < 100 K	≤ 400 ppm / °C

Max. wire resistance:

Influence of wire resistances:	50 Ω for 3- and 4-wire
Open circuit recognition:	max. + 0.25°C at 50 Ω wire resistance
Range of man. fine adjustment	Output signal > 10 V or > 20 mA, LED blinks
Status LED:	≥ ± 5%, from ver. 1: ≥ 12.5%, potentiometer ≥ 12.5 %...25 %

General

Supply voltage	18 Vdc ... 24 Vdc ... 30 Vdc
Power consumption	830 mW ... 880 mW ... 980mW @ I _{out} = 20 mA
Current carrying capacity of cross-connection	≤ 2 A
Operating temperature	0...55°C
Storage temperature	-20...85°C
Factory setting	PT 100/3 0 ... 100 °C / 4 ... 20 mA
Dimensions L/H/B mm	No manual fine adjustment; slow step response
Weight	92.4 / 112.5 / 17.5
Approvals	approx. 100 g
	CE, cUL, GL

Coordination of insulation according to DIN EN 50178, 04/91

Rated voltage	300 V
Surge voltage	4 kV
Overvoltage category	III
Contamination class	2
Clearance and creepage distance	3 mm
Test voltage	2 kV _{eff}

Standards/specifications

EMC standards	EN 50178, IEC751
Dimensions and accessories see	EN 50081, EN50082, EN55011
	Page 298 + 308

* T_J = 23 °C single module

PRO RTD



Adjustment help WAVEtool

This service tool enables quick and uncomplicated configuration of WAVEANALOG PRO. Download from Internet: <http://www.weidmueller.de> → Products → Downloads (see page 192)

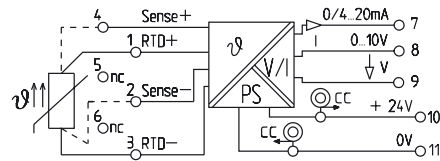

Type	Cat. No.
WAS5 PRO RTD	8560700000
WAZ5 PRO RTD	8560710000
configurable	

PT100/2-/3-/4-wire: -200°C to 850°C
Ni100 : -60°C to +250°C
Potentiometer: min: 0...100Ω / max:0...100kΩ
Resistance: 0 ... 450Ω /

Output voltage	0...10 V	
Offset voltage	max. 0.05 V	
Load resistance	≥ 1 kΩ	
Output current	0/4 ... 20 mA	
Offset current	max. 100 μA	
Load resistance	≤ 600 Ω	
Accuracy, slow/fast step response		
Step response (switchable via DIP switch)		
RTD, R	typ. fast	slow
Potentiometer	< 1.2 s	< 2.2 s
Temperature coefficient	measurement range ≥ 200 K	≤ 200 ppm / °C
	100 K ≤ measurement range < 200 K	≤ 250 ppm / °C
	40 K ≤ measurement range < 100 K	≤ 400 ppm / °C

Max. wire resistance:	50 Ω for 3- and 4-wire
Influence of wire resistances:	max. + 0.25°C at 50 Ω wire resistance
Open circuit recognition:	Output signal > 10 V or > 20 mA, LED blinks
Range of man. fine adjustment	≥ ± 5%, from ver. 1: ≥ 12.5%, potentiometer ≥ 12.5 %...25 %
Status LED:	Module active: LED lit / open circuit: LED blinks
	Error: LED off

Supply voltage	18 Vdc ... 24 Vdc ... 30 Vdc
Power consumption	830 mW ... 880 mW ... 980mW @ I _{out} = 20 mA
Current carrying capacity of cross-connection	≤ 2 A
Operating temperature	0...55°C
Storage temperature	-20...85°C
Factory setting	PT 100/3 0 ... 100 °C / 4 ... 20 mA
Dimensions L/H/B mm	No manual fine adjustment; slow step response
Weight	92.4 / 112.5 / 17.5
Approvals	approx. 100 g
	CE, cUL, GL

Rated voltage	300 V
Surge voltage	4 kV
Overvoltage category	III
Contamination class	2
Clearance and creepage distance	3 mm
Test voltage	2 kV _{eff}

Standards/specifications	EN 50178, IEC751
EMC standards	EN 50081, EN50082, EN55011
Dimensions and accessories see	Page 298 + 308

Input	Switch 1		
	1	2	3
PT100 2-wire	■	■	■
PT100 3-wire		■	■
PT100 4-wire.	■		■
R 2-wire			■
Ni100 2-wire	■	■	
Ni100 3-wire		■	
Ni100 4-wire	■		
Potentiometer			

■ = on
□ = off

∅ _{min}	R _{min}	Pot.min	Switch 1			
			4	5	6	7
0°C	0 Ω	0%	■	■	■	■
-10°C	10 Ω	10%	■	■	■	
-20°C	20 Ω	20%	■	■	■	■
-25°C	20 Ω	25%	■	■		
-30°C	30 Ω	30%	■		■	■
-40°C	40 Ω	40%	■		■	
-50°C	50 Ω	50%	■		■	■
-60°C	60 Ω	60%	■			
-70°C	70 Ω	70%		■	■	■
-80°C	80 Ω	80%		■	■	
-90°C	90 Ω			■		■
-100°C	100 Ω			■		
-150°C	150 Ω				■	■
-200°C	200 Ω				■	
Special range						■

T	R	pot.	Switch 2				
			1	2	3	4	5
40K	20Ω	20%	■	■	■	■	■
50K	25Ω	25%	■	■	■	■	
60K	30Ω	30%	■	■	■	■	■
70K	35Ω	35%	■	■	■		
80K	40Ω	40%	■	■	■	■	■
90K	45Ω	45%	■	■	■		
100K	50Ω	50%	■	■	■	■	■
110K	55Ω	55%	■	■			
120K	60Ω	60%	■	■	■	■	■
125K	62.5Ω	62.5%	■	■	■	■	■
130K	65Ω	65%	■	■	■	■	■
140K	70Ω	70%	■	■			
150K	75Ω	75%	■	■	■	■	■
160K	80Ω	80%	■	■	■		
170K	85Ω	85%	■	■	■	■	■
180K	90Ω	90%	■				
190K	95Ω	95%		■	■	■	■
200K	100Ω	100%		■	■	■	■
250K	125Ω	---		■	■	■	■
300K	150Ω	---		■	■	■	■
350K	175Ω	---		■	■	■	■
400K	200Ω	---		■	■	■	■
450K	225Ω	---		■	■	■	■
500K	250Ω	---		■			
550K	275Ω	---		■	■	■	■
600K	300Ω	---		■	■	■	■
650K	325Ω	---		■	■	■	■
700K	350Ω	---		■			
750K	375Ω	---		■	■	■	■
800K	400Ω	---		■			
850K	425Ω	---		■	■	■	■
900K	450Ω	---		■			

Output	Switch 2	
	6	7
0...10V	■	
0...20mA		
4...20mA	■	

Switching on the manual fine adjustment	
man. adj..	S.1
off	8
on	■

Time of step response	S.2
	8
slow	■
fast	

Thermo-Signal Conditioners

WAVEANALOG Thermo

- thermocouples K, J, T, E, N, R, S, B configurable
- temperature range -200 °C ... +1820 °C
- no adjustment necessary
- cold junction compensation
- configurable output signal
- cross-connectable voltage supply via cross-connectors

Approvals:



Block diagram



Ordering data

Screw connection

Tension clamp connection

Input/output

Technical data*

Input signal

Types

Output signal

Load resistance

Output signal

Load resistance

Output signal

Load resistance

Accuracy at Tu = 23 °C

Temperature coefficient

Response time without filter

Response time with filter

General

Voltage supply

Power consumption

Current carrying capacity of cross-connection

Open circuit recognition

Operating temperature

Storage temperature

Standards/specifications

EMC standards

Dimensions L / H / W mm

Approvals

Dimensions and accessories see

* Tu = 23 °C single module

Thermo Select

°C / 0 ... 20 mA,

4 ... 20 mA, 0 ... 10 V

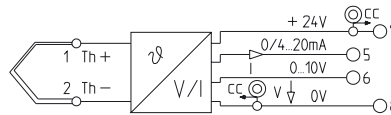

Type	Cat. No.
WTS4 Thermo Select	8432300000
WTZ4 Thermo Select	8432310000
°C / 0 ... 20 mA	
°C / 4 ... 20 mA	
°C / 0 ... 10 V	

Thermocoupler acc. to IEC584 (fully insulated)

K -200 ... +1372 °C

J -200 ... +1200 °C

T -200 ... +400 °C

E -200 ... +1000 °C

N -200 ... +1300 °C

R -50 ... +1760 °C

S -50 ... +1760 °C

B +50 ... +1820 °C

0 ... 20 mA

≤ 500 Ω

4 ... 20 mA

≤ 500 Ω

0 ... 10 V

≥ 1 kΩ

Type K -200°C ... -150°C ± (5K + 0.1% of set range)

-150°C ... 1200°C ± (3K + 0.1% of set range)

1200°C ... 1372°C ± (4K + 0.1% of set range)

Type J -200°C ... -150°C ± (4K + 0.1% of set range)

-150°C ... 1200°C ± (3K + 0.1% of set range)

Type T -200°C ... -150°C ± (5K + 0.1% of set range)

-150°C ... 400°C ± (3K + 0.1% of set range)

Type E -200°C ... -150°C ± (4K + 0.1% of set range)

-150°C ... 1000°C ± (3K + 0.1% of set range)

Type N -200°C ... -150°C ± (6K + 0.1% of set range)

-150°C ... 1300°C ± (3K + 0.1% of set range)

Type R -50°C ... 200°C ± (10K + 0.1% of set range)

200°C ... 1760°C ± (6K + 0.1% of set range)

Type S -50°C ... 200°C ± (10K + 0.1% of set range)

200°C ... 1760°C ± (6K + 0.1% of set range)

Type B 50°C ... 250°C ± (25K + 0.1% of set range)

250°C ... 500°C ± (10K + 0.1% of set range)

500°C ... 1820°C ± (6K + 0.1% of set range)

± (200 ppm v. Span

+ 0.075 K) /K

1.1 s

6 s

24 Vdc ±20% (19.2 ... 28.8 Vdc)

< 38 mA at I_{out} = 20 mA

≤ 2 A

LED blinks (output value: > 20 mA and. > 10 V)

0 °C ... +55 °C

-20 °C ... +85 °C

EN 50178, IEC584

EN 50081, EN 50082, EN 55011

92.4 / 112.5 / 12.5

CE, UL, CSA

Page 298 + 308

Switch position/setting options

SW 1				SW 2					
Type	1	2	3	Span	1	2	3	4	5
K	■	■	■	100 °C	■	■	■	■	■
J	■	■	■	150 °C	■	■	■	■	■
T	■	■	■	200 °C	■	■	■	■	■
E	■	■	■	250 °C	■	■	■	■	■
N	■	■	■	300 °C	■	■	■	■	■
R	■	■	■	350 °C	■	■	■	■	■
S	■	■	■	400 °C	■	■	■	■	■
B	■	■	■	450 °C	■	■	■	■	■
SW 1				500 °C	■	■	■	■	■
Tmin				550 °C	■	■	■	■	■
0 °C				600 °C	■	■	■	■	■
-10 °C				650 °C	■	■	■	■	■
-20 °C				700 °C	■	■	■	■	■
-30 °C				750 °C	■	■	■	■	■
-40 °C				800 °C	■	■	■	■	■
-50 °C				850 °C	■	■	■	■	■
-100 °C				900 °C	■	■	■	■	■
-150 °C				950 °C	■	■	■	■	■
-200 °C				1000 °C	■	■	■	■	■
+50 °C				1050 °C	■	■	■	■	■
+100 °C				1100 °C	■	■	■	■	■
+150 °C				1150 °C	■	■	■	■	■
+200 °C				1200 °C	■	■	■	■	■
+250 °C				1250 °C	■	■	■	■	■
+500 °C				1300 °C	■	■	■	■	■
SW 2				1350 °C	■	■	■	■	■
Output				1400 °C	■	■	■	■	■
0 - 10 V				1450 °C	■	■	■	■	■
0 - 20 mA				1500 °C	■	■	■	■	■
4 - 20 mA				1600 °C	■	■	■	■	■
Filter				1700 °C	■	■	■	■	■
off				1800 °C	■	■	■	■	■
on									

■ = on
□ = off

Thermo Signal Isolating Transformers (Configurable)

WAVEANALOG PRO Thermo

- 3-way-isolation
- thermocouples
K, J, T, E, N, R, S, B configurable
- temperature range
-200 °C ... +1820 °C
- no adjustment necessary
- cold junction compensation
- configurable output signal
- cross-connectable voltage supply via cross-connectors

Approvals:



Block diagram



Ordering data

Screw connection
Tension clamp connection
Input/output

Technical data*

Input (adjustable)

Accuracy at Tu = 23 °C

Output (adjustable)

Output voltage: 0...10 V
 Offset voltage: Max. 0.05 V
 Load resistance: ≥ 1 KΩ
 Output current: 0/4 ... 20 mA
 Offset current: max. 100 μA
 Load resistance: ≤ 600 Ω
 Step response: max. 1.4 s
 at connected filter function: max. 7.5 s
 Max. wire resistance: 50 Ω for 3- and 4-wire
 Open circuit recognition: Output signal > 10 V or > 20 mA, LED blinks
 Range of man. fine adjustment: ≥ ±5%
 Status LED: Module active: LED lights up / open circuit: LED blinks
 Error: LED off

General

Supply voltage: 18 Vdc ... 24 Vdc ... 30 Vdc
 Power consumption: 800 mV ... 850 mW ... 950 mW @ I output = 20 mA
 Current carrying capacity of cross-connection: ≤ 2 A
 Operating temperature: 0 °C ... +55 °C
 Storage temperature: -20 ... +85 °C

Standards/specifications

EN 50178, IEC751
 EN 50081, EN50082, EN55011

Factory setting

Type K 0 ... 1000 °C / 4 ... 20 mA; no filter;
 No manual fine adjustment

Dimensions L/H/W mm: 92.4 / 112.5 / 17.5

Weight: 100 g

Approvals: CE, cUL, GL

Dimensions and accessories see Page 298 + 308

* Tu = 23 °C single module

PRO Thermo



Adjustment help WAVE TOOL

This service tool enables quick and uncomplicated configuration of WAVEANALOG PRO. Download from the Internet: <http://www.weidmueller.de> → Products → Downloads (see page 192)

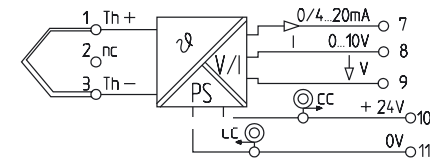

Type	Cat. No.
WAS5 PRO Thermo	8560720000
WAZ5 PRO Thermo	8560730000

Thermocouples acc. to EN 60584-1

Type K, J, E, N, R, S, B via DIP switch selectable

Type K -200°C ... -150°C ± (5K + 0.1% of set range)

-150°C ... 1200°C ± (3K + 0.1% of set range)

1200°C ... 1372°C ± (4K + 0.1% of set range)

Type J -200°C ... -150°C ± (4K + 0.1% of set range)

-150°C ... 1200°C ± (3K + 0.1% of set range)

Type T -200°C ... -150°C ± (5K + 0.1% of set range)

-150°C ... 400°C ± (3K + 0.1% of set range)

Type E -200°C ... -150°C ± (4K + 0.1% of set range)

-150°C ... 1000°C ± (3K + 0.1% of set range)

Type N -200°C ... -150°C ± (6K + 0.1% of set range)

-150°C ... 1300°C ± (3K + 0.1% of set range)

Type R -50°C ... 200°C ± (10K + 0.1% of set range)

200°C ... 1760°C ± (6K + 0.1% of set range)

Type S -50°C ... 200°C ± (10K + 0.1% of set range)

200°C ... 1760°C ± (6K + 0.1% of set range)

Type B 50°C ... 250°C ± (25K + 0.1% of set range)

250°C ... 500°C ± (10K + 0.1% of set range)

500°C ... 1820°C ± (6K + 0.1% of set range)

0...10 V

Max. 0.05 V

≥ 1 KΩ

0/4 ... 20 mA

max. 100 μA

≤ 600 Ω

max. 1.4 s

max. 7.5 s

50 Ω for 3- and 4-wire

Output signal > 10 V or > 20 mA, LED blinks

≥ ±5%

Module active: LED lights up / open circuit: LED blinks

Error: LED off

Selection the thermocoupler			
Type	SW1		
	1	2	3
K	■	■	■
J	■	■	■
T	■	■	■
E	■	■	■
N	■	■	■
R	■	■	■
S	■	■	■
B	■	■	■

Selection of minimum temperature						
θ _{min}	SW1					
	4	5	6	7	8	9
0°C	■	■	■	■	■	■
-10°C	■	■	■	■	■	■
-20°C	■	■	■	■	■	■
-30°C	■	■	■	■	■	■
-40°C	■	■	■	■	■	■
-50°C	■	■	■	■	■	■
-100°C	■	■	■	■	■	■
-150°C	■	■	■	■	■	■
-200°C	■	■	■	■	■	■
+50°C	■	■	■	■	■	■
+100°C	■	■	■	■	■	■
+150°C	■	■	■	■	■	■
+200°C	■	■	■	■	■	■
+250°C	■	■	■	■	■	■
500°C	■	■	■	■	■	■
Special range	■	■	■	■	■	■

Selection of temperature span					
Span	SW2				
	1	2	3	4	5
100°C	■	■	■	■	■
150°C	■	■	■	■	■
200°C	■	■	■	■	■
250°C	■	■	■	■	■
300°C	■	■	■	■	■
350°C	■	■	■	■	■
400°C	■	■	■	■	■
450°C	■	■	■	■	■
500°C	■	■	■	■	■
550°C	■	■	■	■	■
600°C	■	■	■	■	■
650°C	■	■	■	■	■
700°C	■	■	■	■	■
750°C	■	■	■	■	■
800°C	■	■	■	■	■
850°C	■	■	■	■	■
900°C	■	■	■	■	■
950°C	■	■	■	■	■
1000°C	■	■	■	■	■
1050°C	■	■	■	■	■
1100°C	■	■	■	■	■
1150°C	■	■	■	■	■
1200°C	■	■	■	■	■
1250°C	■	■	■	■	■
1300°C	■	■	■	■	■
1350°C	■	■	■	■	■
1400°C	■	■	■	■	■
1450°C	■	■	■	■	■
1500°C	■	■	■	■	■
1600°C	■	■	■	■	■
1700°C	■	■	■	■	■
1800°C	■	■	■	■	■

■ = on
 □ = off

Coordination of insulation acc. to DIN EN 50178, 04/98

Rated voltage	300 V
Surge voltage	4 kV
Overvoltage category	III
Contamination class	2
Clearance & creep. distance	3 mm
Test voltage	2 kV _{eff}

Selection of output		
Output	SW2	
	6	7
0...10V	■	■
0...20mA	■	■
4...20mA	■	■

Switching on the manual fine adjustment

SW1	
man. adjust.	8
off	■
on	■

Switching on the filter function

Filter	SW2
	8
off	■
on	■

Adjustment Help WAVE TOOL

The adjustment help – **WAVE TOOL** – enables quick and uncomplicated configuration of **WAVEANALOG PRO DC**, **WAVEANALOG PRO RTD**, **WAVEANALOG PRO THERMO**.

Menu for selecting the functions



Once the required input and output parameters have been entered, the program determines the correct switch setting and gives instructions for the electrical connection of the module. Where necessary, it also determines and displays the required calibration values. The entire process can be printed out or saved as a PDF file for installation documentation purposes.

Download from the Internet:

<http://www.weidmueller.de> ⇨ Products ⇨ Download

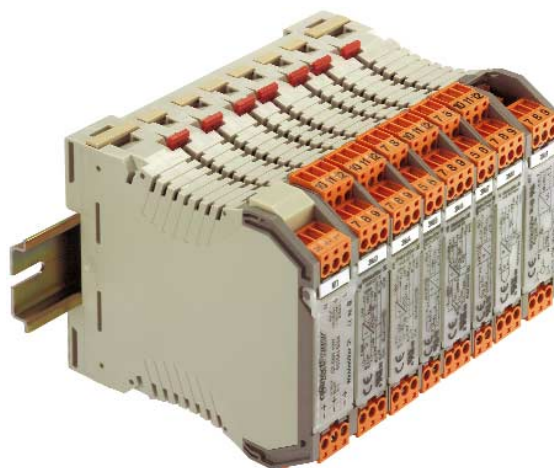

For configuring the current/voltage isolating transformer

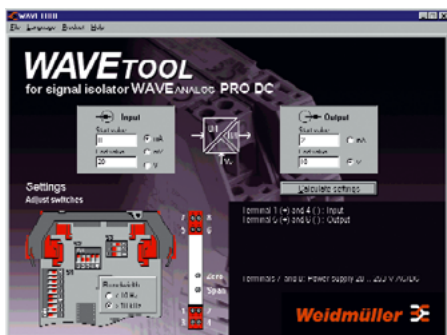

Printout of protocol for the documentation

WAVE TOOL
for signal isolator WAVEANALOG PRO RTD

Note: Weidmüller Interface GmbH

Input: Type: PT100 / 4-wire
Start value: 0°C / 32°F
End value: 100°C / 212°F

Output: Output voltage: 0 .. 10 V
Response time: slow 2,2s
Fine calibration: off

Settings: Adjust switches

Weidmüller

Weidmüller Interface GmbH & Co.
P.O. Box 3030
D-32729 Detmold
T: +49-(0)5231-14-0
F: +49-(0)5231-14-2083
Date: 02.04.02

Terminal 1: RTD+ (Source+)
Terminal 2: Sense-
Terminal 3: RTD- (Source-)
Terminal 4: Sense+

Terminal 8: Output 0 .. 10 V
Terminal 9: Gnd

Terminal 10: Power supply +18 .. 30 V DC
Terminal 11: Gnd

For configuring the temperature signal isolating transformer

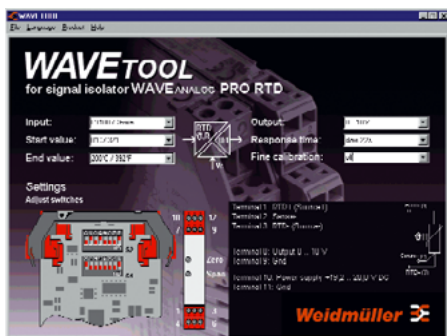

For configuring the thermo signal isolating transformer

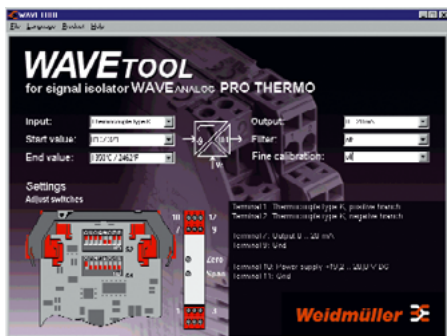

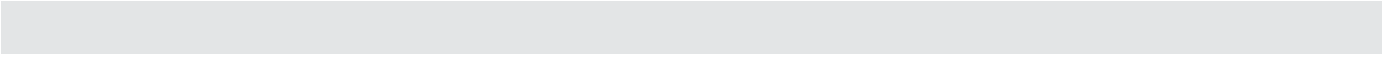

Current monitoring

Monitoring flows of currents enables a constant control of individual devices and installation components.

Discrepancies or disruptions arising in the electrical circuit can easily be evaluated as breakdowns. Targeted rectifying procedures can be taken.

The **WAVECONTROL** range of products convert sinusoidal/non-sinusoidal AC/DC currents up to 60 A to standard analogue signals. The measurement processes are based on 2 basic principles.

One principle is alternating currents up to 10 A ac and 50/60 Hz are measured using the **transformer process**. The module is looped directly into the measurement circuit.

A **Hall-effect** element comes in to operation at 10 A ac/dc.

The potential-free wire is inserted through the module, allowing currents up to 60 A ac/dc to be measured.

Quite often, there are high-frequency parts of signals on the wire to be measured. In order to be able to take these parts of the signals into consideration, so-called **TRMS converters (TRUE Root Mean Square)** are connected to the Hall sensors. This enables measurements up to 2 kHz, independent of the shape of the curve.

Standard signals (0...20, 4...20 mA, 4...20 A current loop supply, 0...10 V) or a switch output are on offer.

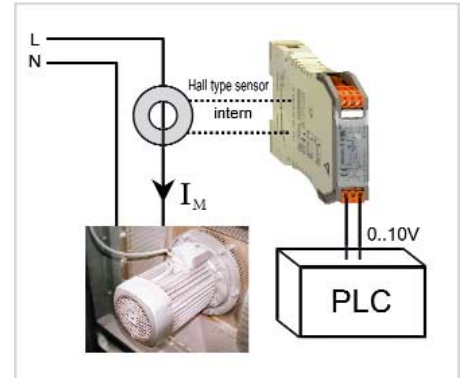
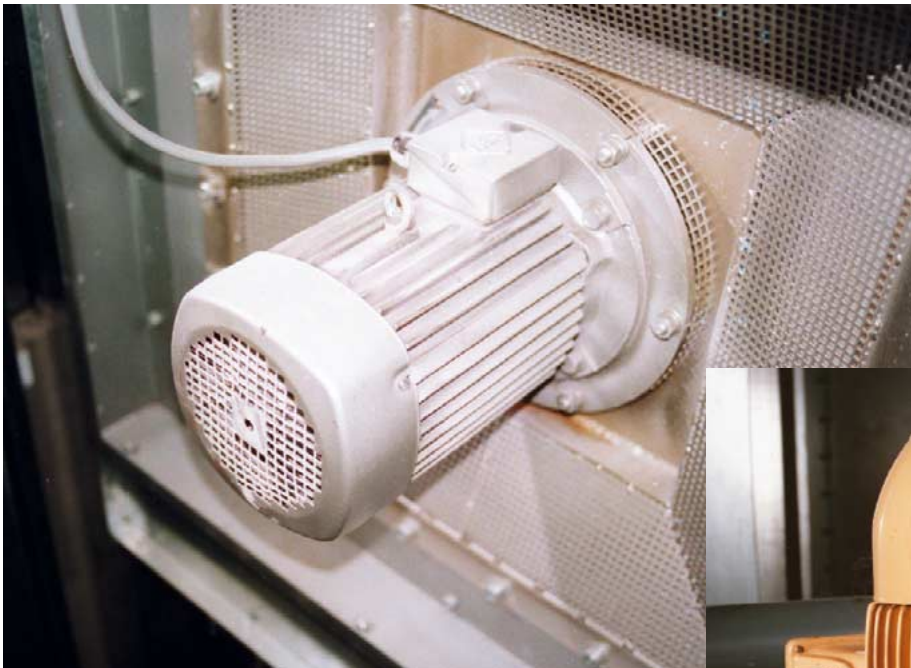

Fig.: Monitoring motor currents



Monitoring a motor in a cooling system



Monitoring a pump in a sewage treatment plant

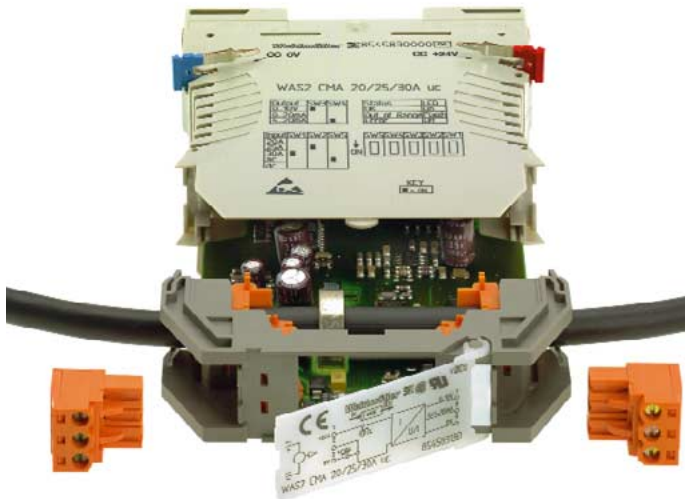

Galvanically isolated measurement circuit

Measurements of direct and alternating currents possible

TRMS versions for measuring non sinusoidal signals

Measurement range switch without calibration

Relay version with selectable hysteresis

Selectable working and closed-circuit current process for defined statuses (optional as normally open or normally closed contact)

Error indication via LED indication

Less wiring costs thanks to cross-connections

Very good marking options

Fast commissioning – pluggable replacement PCBs

Connection technology – screw or tension clamp via socket block

Tool-free mounting

Coding elements in the connections – false plugging not possible

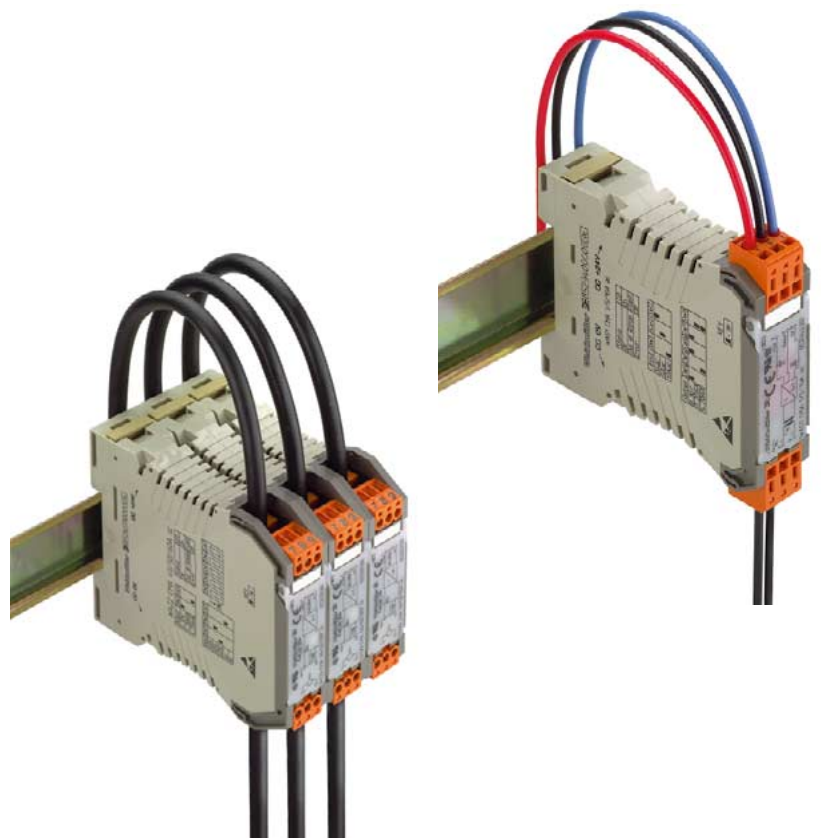

Current Monitoring

WAVECONTROL

- current ranges adjustable via DIP switch
- cross-connectable voltage supply via cross-connectors
- selectable hysteresis
- selectable working and closed-circuit current principle

Approvals:



Block diagram

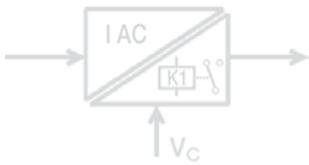

WAS2 CMR WAZ2 CMR

1/5/10 A ac
selectable with
relay output



WAS2 CMR WAZ2 CMR

20/40/60A ac
selectable with
relay output

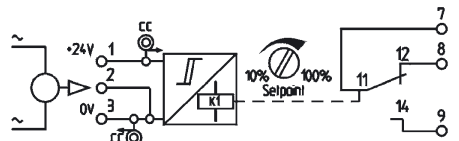
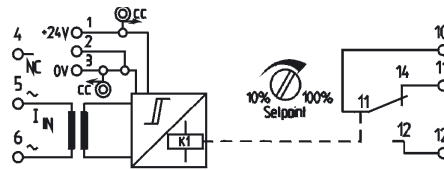

Ordering data

Screw connection	Type	Cat. No.	Qty.
Tension clamp connection	WAS2 CMR 1/5/10A ac	8516560000	1
	WAZ2 CMR 1/5/10A ac	8516570000	1

Technical data*

Input	
Input current	1A ac/5A ac/10A ac selectable (without additional adjustment)
Input frequency	50Hz/60Hz
Pass through diameter	8mm
Measuring principle	transformer coupled
Connection type	screw or tension clamp connection
Measurement circuit voltage	250Vac

Max. measuring circuit

	100A for 1s
--	-------------

Output

Contact set	1 changeover contact
Min. switching voltage	6Vdc/6Vac
Max. switching voltage	60Vdc/250Vac
Continuous current AC	3A
Continuous current DC	0.7A
Max. switching current	7A
Min. switching current	100mA
Status LED	green LED
Threshold	10% ... 100% adjustable via front potentiometer
Hysteresis	approx. 5% or approx. 10% selectable from set threshold
Temperature coefficient	≤ 800 ppm/K
Response time (10 ... 90%)	typ. 700 ms
Working/closed-circuit current principle	selectable

Coordination of insulation acc. to DIN EN 50178, 04/98

Rated voltage	300V
Surge voltage	4kV
Overvoltage category	III
Contamination class	2
Clearance and creepage distance	≥ 3 mm
Test voltage	4kV eff

General

Supply	
Supply voltage	21.6Vdc...24Vdc...26.4Vdc
Power consumption at rated voltage	8.3 mA (relay not switched) 24 mA (relay switched)
Reverse polarity protection	yes
Current carrying capacity of the cross-connection	≤ 2 A
Operating temperature range	0 ... 50°C
Storage/transport	-20 ... +70°C
Factory setting	Input range: 5A ac; hysteresis 10%, working current principle
Dimensions L/H/B (mm)	92.4/112.4/22.5
Weight	150g
Approvals	CE, cUL
Dimensions and accessories see	Page 298 + 308

* T_U = 23 °C single module

Ordering data

Screw connection	Type	Cat. No.	Qty.
Tension clamp connection	WAS2 CMR 20/40/60A ac	8513340000	1
	WAZ2 CMR 20/40/60A ac	8526600000	1

Technical data*

Input	
Input current	20A ac/40A ac/60A ac selectable (without additional adjustment)
Input frequency	50Hz/60Hz
Pass through diameter	8mm
Measuring principle	Contact-free current monitoring using Hall sensor
Connection type	Push-through connection
Measurement circuit voltage	400Vac, higher voltages dependent on wire insulation

Max. measuring circuit

	dependent on wire cross-section
--	---------------------------------

Output

Contact set	1 changeover contact
Min. switching voltage	6Vdc/6Vac
Max. switching voltage	60Vdc/250Vac
Continuous current AC	3A
Continuous current DC	0.7A
Max. switching current	7A
Min. switching current	100mA
Status LED	green LED
Threshold	10% ... 100% adjustable via front potentiometer
Hysteresis	approx. 5% or approx. 10% selectable from set threshold
Temperature coefficient	≤ 250 ppm/K
Response time (10 ... 90%)	typ. 700 ms
Working/closed-circuit current principle	selectable

Coordination of insulation acc. to DIN EN 50178, 04/98

Rated voltage	300V
Surge voltage	4kV
Overvoltage category	III
Contamination class	2
Clearance and creepage distance	≥ 3 mm
Test voltage	4kV eff

General

Supply	
Supply voltage	21.6Vdc...24Vdc...26.4Vdc
Power consumption at rated voltage	23 mA (relay not switched) 47 mA (relay switched)
Reverse polarity protection	yes
Current carrying capacity of the cross-connection	≤ 2 A
Operating temperature range	0 ... 50°C
Storage/transport	-20 ... +70°C
Factory setting	Input range :40A ac; hysteresis 10% working current principle
Dimensions L/H/B (mm)	92.4/112.4/22.5
Weight	150g
Approvals	CE, cUL
Dimensions and accessories see	Page 298 + 308

Current Monitoring

WAVECONTROL

- input and output range adjustable via DIP switch
- no calibration required
- cross-connectable voltage supply via cross-connectors

Approvals:



Block diagram

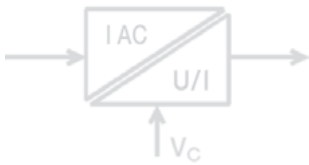

WAS1 CMA WAZ1 CMA

1/5/10A ac selectable with analogue output
0...20 mA /
4...20 mA
0...10 V



WAS1 LP CMA WAZ1 LP CMA

1/5/10 A ac selectable with analogue output
4...20 mA
loop powered



Ordering data

Screw connection

Tension clamp connection

Technical data*

Input

Input current

Input frequency

Accuracy

Measuring principle

Connection type

Measurement circuit voltage

Max. measuring circuit

Output

Current/voltage selectable

Output voltage

Offset voltage

Load resistance

Output signal limit

Output current

Offset current

Load resistance

Status LED

Temperature coefficient

Response time (10 ... 90%)

Coordination of insulation acc. to DIN EN 50178, 04/98

(safe separation)

Rated voltage

Surge voltage

Overvoltage category

Contamination class

Clearance and creepage distance

Test voltage

General

Supply

Supply voltage

Power consumption at rated voltage

Reverse polarity protection

Operating temperature range

Storage/transport

Factory setting

Dimensions L/H/W (mm)

Weight

Approvals

Dimensions and accessories see

* T_U = 23 °C single module

Type	Cat. No.	Qty.
WAS1 CMA 1/5/10A ac	8523400000	1
WAZ1 CMA 1/5/10A ac	8523410000	1

1 A ac/5 A ac/10 A ac selectable (without additional adjustment)

50 Hz/60 Hz

0.5% FSR

transformer coupled

Screw or tension clamp connection

250 Vac

100 A for 1s

0 ... 10 V

0 ... 20 mA

4 ... 20 mA

0 ... 10 V

max. 0.05 V

≥ 1 K Ω

approx. 13 V and 24 mA

0/4 ... 20 mA

max. 100 μA

≤ 600 Ω

green LED

ON → OK; blinks → signal out of range; OFF → Error

≤ 200 ppm/K

typ. 700 ms

300V

6KV

III

2

≥ 5.5 mm

4kV eff

21.6 Vdc...24 Vdc...26.4 Vdc

40 mA at I_{out} = 20 mA

yes

0 ... 50°C

- 20 ... + 70°C

0 ... 5A ac; 4 ... 20mA

72/92.4/22.5

150g

CE, cUL

Page 298 + 308

Type	Cat. No.	Qty.
WAS1 LP CMA 1/5/10A ac	8528650000	1
WAZ1 LP CMA 1/5/10A ac	8528660000	1

1A ac/5A ac/10A ac selectable (without additional adjustment)

50 Hz/60 Hz

0.5% FSR

transformer coupled

Screw or tension clamp connection

250 Vac

100 A for 1s

4 ... 20mA current loop supply

approx. 24 mA

4 ... 20 mA

max. 100 μA

≤ 550 Ω (at 24 V) RL = (V_{cc} - 13V) / 20 mA

Dependent on voltage V_{cc}

green LED

ON → OK; blinks → signal out of range; OFF → Error

≤ 200 ppm/K

typ. 700 ms

300V

6KV

III

2

≥ 5.5 mm

4kV eff

13 Vdc ... 30 Vdc

yes

0 ... 50°C

-20 ... +70°C

0 ... 5A ac; 4 ... 20mA

72/92.4/22.5

150g

CE, cUL

Page 298 + 308

Current Monitoring

WAVECONTROL

- input and output range adjustable via DIP switch
- no calibration required
- true TRMS value measurements
- hall sensor measurement method

Approvals:



Block diagram

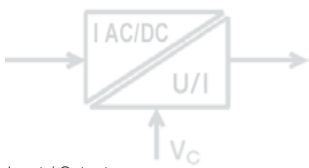

Input / Output configurable

Ordering data	
Screw connection	
Tension clamp connection	
Technical data*	
Input	
Input current	5 A uc/10 A uc selectable (without additional adjustment)
Input frequency	0 Hz - 2 kHz (True RMS to DC Converter)
Accuracy	1% (0 Hz - 1 kHz) Crest factor 3 FSR 2% (0 Hz - 2 kHz) Crest factor 5 FSR
Measuring principle	Contact-free current monitoring using Hall sensor
Connection type	Push-through connection
Pass through diameter	8 mm
Measurement circuit voltage	400 Vac, higher voltages dependent on wire insulation
Max. measuring circuit	dependent on wire cross-section
Output	
Current/voltage selectable	0 ... 10 V 0 ... 20 mA 4 ... 20 mA
Output voltage	0 ... 10 V
Offset voltage	max. 0.08 V
Load resistance	≥ 1 KΩ
Output signal limit	approx. 13 V and. 24 mA
Output current	0/4 ... 20 mA
Offset current	max. 150 μA
Load resistance	≤ 600 Ω
Status LED	green LED ON → OK; blinks → signal out of range; OFF → Error
Temperature coefficient	≤ 650 ppm/K
Response time (10 ... 90%)	typ. 700 ms
Coordination of insulation acc. to DIN EN 50178, 04/98 (safe separation)	
Rated voltage	300 V
Surge voltage	6 kV
Overtoltage category	III
Contamination class	2
Clearance and creepage distance	≥ 5.5 mm
Test voltage	4 kV eff
General	
Supply	
Supply voltage	21.6 Vdc...24 Vdc...26.4 Vdc
Power consumption at rated voltage	50 mA at I _{out} = 20 mA
Reverse polarity protection	yes
Operating temperature range	0 ... 50 °C
Storage/transport	-20 ... +70 °C
Factory setting	0 ... 5A uc; 4 ... 20 mA
Dimensions L/H/B (mm)	92.4/112.4/22.5
Weight	150 g
Approvals	CE, cUL
Dimensions and accessories see	Page 298 + 308

* Tu = 23 °C single module

WAS2 CMA WAZ2 CMA

5/10A ac/dc selectable with analogue output
0 ... 20 mA/
4 ... 20 mA/
0 ... 10 V



WAS2 CMA WAZ2 CMA

20/25/30A ac/dc selectable with analogue output
0 ... 20 mA/
4 ... 20 mA/
0 ... 10 V

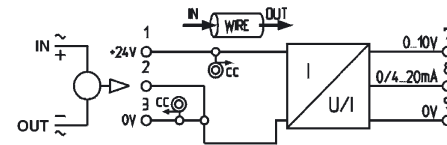

Type	Cat. No.	Qty.
WAS2 CMA 5/10A uc	8526610000	1
WAZ2 CMA 5/10A uc	8526620000	1

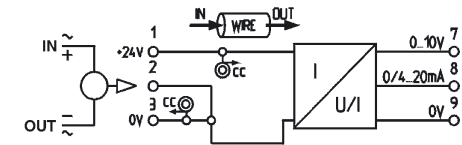

Type	Cat. No.	Qty.
WAS2 CMA 20/25/30A uc	8545830000	1
WAZ2 CMA 20/25/30A uc	8545840000	1

Current Monitoring

WAVECONTROL

- input and output range adjustable via DIP switch
- no calibration required
- cross-connectable voltage supply via cross-connectors
- true TRMS value measurements
- hall sensor measurement method

Approvals:



Block diagram

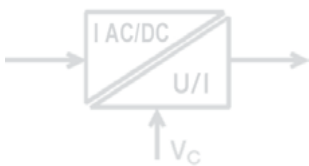

WAS2 CMA WAZ2 CMA

40/50/60A ac/dc
selectable with
analogue output
0 ... 20 mA/
4 ... 20 mA/
0 ... 10 V

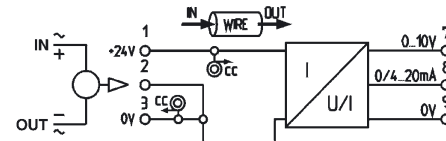

Ordering data

Screw connection

Tension clamp connection

Technical data*

Input

Input current

Input frequency

Accuracy

Measuring principle

Connection type

Pass through diameter

Measurement circuit voltage

Max. measuring circuit

Output

Current/voltage selectable

Output voltage

Offset voltage

Load resistance

Output signal limit

Output current

Offset current

Load resistance

Status LED

Temperature coefficient

Response time (10 ... 90%)

Coordination of insulation acc. to DIN EN 50178, 04/98

(safe separation)

Rated voltage

Surge voltage

Oversvoltage category

Contamination class

Clearance and creepage distance

Test voltage

General

Supply

Supply voltage

Power consumption at rated voltage

Reverse polarity protection

Operating temperature range

Storage/transport

Factory setting

Dimensions L/H/W (mm)

Weight

Approvals

Dimensions and accessories see

* Tu = 23 °C single module

Type	Cat. No.	Qty.
WAS2 CMA 40/50/60A uc	8513330000	1
WAZ2 CMA 40/50/60A uc	8526590000	1

Current Monitoring

- For AC/DC
- With and without adjustable switching threshold
- Opto-coupler output

SMSI DC O

With adjustable switching threshold

Up to 50 mA

Up to 250 mA



This series is particularly suitable for monitoring small currents from 50 mA to 5 A.

The adjustable switching threshold activates optionally one relay- or opto-coupler output each.

Block diagram/ timing diagram

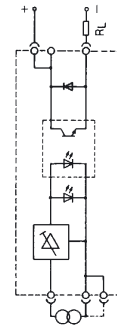
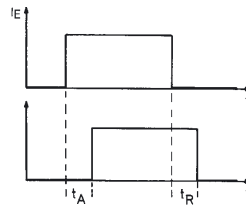

Ordering data

Type	Cat. No.	Type	Cat. No.
SMSI 0.05 DC O	1157160000	SMSI 0.25 DC O	1156360000

Technical data

Measurement circuit voltage	10 V... 250 Vdc	10 V... 250 Vdc
Max. permissible current in measurement circuit	70 mA	350 mA
Rated consumption – (W)	200 mW	750 mW
Rated consumption – (VA)	–	–
Adjustable switching threshold	1 mA...50 mA	40 mA...250 mA
Hysteresis between turn-on and turn-off point	0.5 % (50 mA)...5 % (1 mA)	2% (250 mA)...10% (40 mA)
Activation time t_A	< 10 ms	< 3 ms
Reaction time t_R	< 10 ms	< 3 ms
Voltage drop at input	< 4 V	< 3 V
Output voltage	5 V...50 Vdc	5 V...50 V–
Max. continuous output current	100 mA	100 mA
Saturation voltage	≤ 1.3 V	≤ 1.3 V
Auxiliary voltage	–	–
Auxiliary voltage rated consumption	–	–
Auxiliary voltage rated data	–	–
Storage temperature	–25 °C...+60 °C	–25 °C...+60 °C
Ambient temperature	–, assembled without spacing on TS –, assembled with ≥ 20 mm spacing on TS	–25 °C...+40 °C –25 °C...+50 °C

Coordination of insulation according to VDE, Draft 11/94

Overvoltage category, input	II	II
Overvoltage category, output	I	I
Overvoltage category, input 1-input 2,	I	I
Output 1-output 2, input-output	III	III
Contamination class	2	2

Dimensions and connection data

see page 306 + 307	Fig. V	Fig. V
--------------------	--------	--------

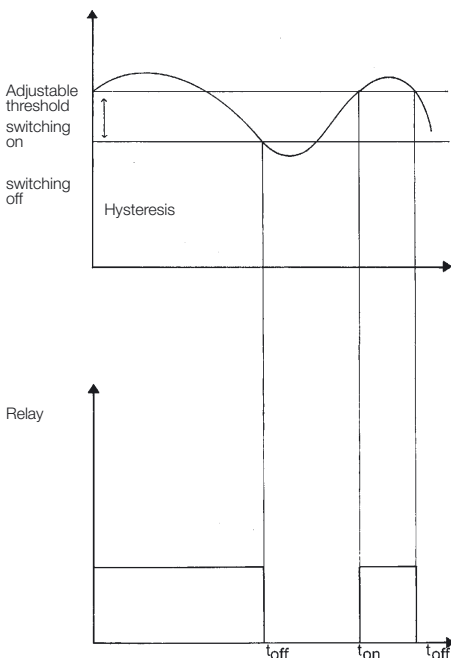

SMSI AC O

With adjustable switching threshold
up to 250 mA Up to 2.5 A



SMSI AC O

Current monitoring units with transistor output up to 5 A
without switching threshold



SMSI AC

Current monitoring with indicator up to 5 A
without switching threshold

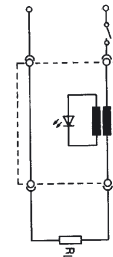
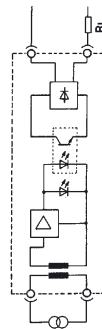
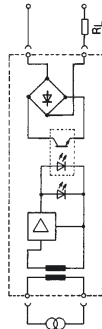
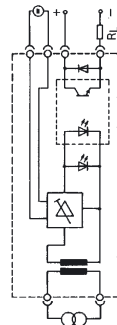
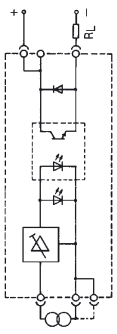

Type	Cat. No.	Type	Cat. No.	Type	Cat. No.	Type	Cat. No.	Type	Cat. No.
SMSI 0.25 AC O	1156460000	SMSI 2.5 AC O	1157360000	SMSI 5 AC O	1112160000	SMSI 5 AC O	8026930000	SMSI 5 AC	1112060000
10 V...250 Vac		10 V...250 Vac		5...250 Vav		5...250 Vac		5...250 Vac	
300 mA		2.8 A		1 A...5 A		1 A...5 A		1 A...5 A	
-		-		-		-		-	
1075 mVA		250 mVA		-		-		-	
40 mA...250 mA		0.2 A...2.2 A		-		-		-	
≤ 5%		≤ approx. 35%		-		-		-	
≤ 40 ms		≤ 55 ms		≤ 10 ms		≤ 10 ms		-	
≤ 15 ms		≤ 20 ms		≤ 20 ms		≤ 20 ms		-	
< 4.3 V~eff (I = 250 mA)		< 100 mV~eff (I = 10 A)		< 200 mV		< 200 mV		< 200 mV	
5 V...50 V~		5 V...50 V~		24 Vuc ± 10%		5...48 Vdc		-	
100 mA		100 mA		100 mA		100 mA		-	
≤ 1.3 V		≤ 1.3 V		< 3.2 V		< 1.6 V		-	
		24 Vuc ± 10%							
		550 mW~/1150 mVA~							
		23 mA~/47 mA~							
-25 °C...+60 °C		-25 °C...+60 °C		-40 °C...+60 °C		-40 °C...+60 °C		-40 °C...+60 °C	
-25 °C...+40 °C		-25 °C...+40 °C		-25 °C...+40 °C		-25 °C...+40 °C		-25 °C...+40 °C	
-25 °C...+50 °C		-25 °C...+50 °C		-25 °C...+50 °C		-25 °C...+50 °C		-25 °C...+50 °C	
II		II		II		II		II	
I		I		I		I		I	
III		III		III		III		III	
2		2		2		2		2	
Fig. V		Fig. V		Fig. II		Fig. II		Fig. II	

Current Monitoring

- For AC/DC
- Adjustable switching threshold
- Relay output

SMSI DC R

With adjustable switching threshold
up to 250 mA

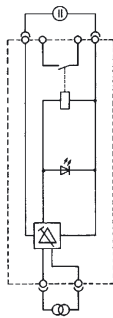
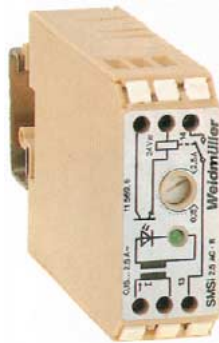

SMSI AC R

With adjustable switching threshold
up to 250 mA

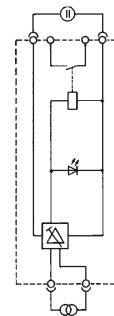

Ordering data

Type	Cat. No.
SMSI 0.25 DC R	1156660000

Type	Cat. No.
SMSI 0.25 AC R	1159960000

Technical data

Measurement circuit voltage	10 V...250 Vdc	10 V...250 Vac
Max. permissible current in measurement circuit	350 mA	300 mA
Rated consumption ~ (VA)	750 mVA (I = 250 mA)	1075 mVA (I = 250 mA)
Voltage drop at input	≤ 3 V (I = 250 mA)	≤ 3 V (I = 250 mA)
Adjustable switching threshold	40 mA...250 mA~	40 mA...250 mA~
Hysteresis between turn-on and turn-off point	2% (250 mA) < IHY < 10% (40 mA)	≤ 5%
Activation time tA	-	≤ 25 ms
Reaction time tR	≤ 12 ms	≤ 15 ms
Recovery	-	-
Output voltage	250 V	250 V
Max. continuous output current	3 A	3 A
Auxiliary voltage	24 V~ ±10%	24 V~ ±10%
Rated consumption auxiliary voltage	250 mW/450 mVA	250 mW/450 mVA
Max. switching current	8 A	8 A
Contact	1 NO ¹⁾	1 NO ¹⁾
Contact material	AgNi, gold-flashed	AgNi, gold-flashed
Storage temperature	-25 °C...+60 °C	-25 °C...+60 °C
Ambient temperature	-	-
- , assembled without spacing on TS	-25 °C...+40 °C	-25 °C...+40 °C
- , assembled with ≥ 20 mm spacing on TS	-25 °C...+50 °C	-25 °C...+50 °C

Coordination of insulation to DIN VDE 0160, Draft 11/94

Overvoltage category, input, output	II	II
Overvoltage category, input1-input2, Output1-output 2, input-output	III	III
Contamination class	2	2

Dimensions and connection data

see page 307	Fig. V	Fig. V
	¹⁾ NC on request	

Current Monitoring

SMSI AC R

With adjustable switching threshold up to 2.5 A

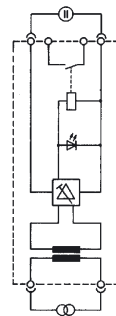
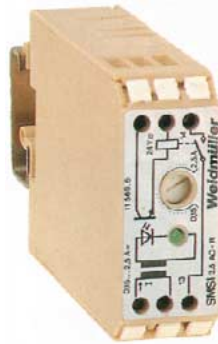

SMSI AC R

Current monitoring with relay output up to 5 A without switching threshold

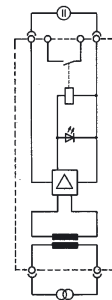
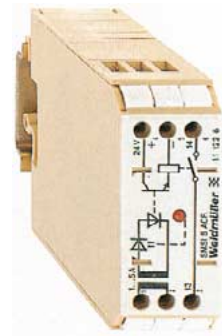

Ordering data

Type	Cat. No.
SMSI 2.5 AC R	1156960000

Technical data

Measurement circuit voltage	10 V...250 Vac
Max. permissible current in measurement circuit	3 A
Rated consumption ~ (VA)	250 mVA (I = 2.5 A)
Voltage drop at input	< 0.1 V (I = 2.5 A)
Adjustable switching threshold	0.2...2.2 A
Hysteresis between turn-on and turn-off point	≤ approx. 5%
Activation time tA	≤ 45 ms
Reaction time tR	≤ 30 ms
Recovery	< 75 ms
Output voltage	250 V
Max. continuous output current	3 A
Auxiliary voltage	24 Vdc ±10%
Rated consumption auxiliary voltage	1000 mW
Max. switching current	5 A
Contact	1 NO ¹⁾
Contact material	AgNi, gold-plated 3 μm
Storage temperature	-40 °C...+60 °C
Ambient temperature	
- , assembled without spacing on TS	-25 °C...+40 °C
- , assembled with ≥ 20 mm spacing on TS	-25 °C...+50 °C

Coordination of insulation to DIN VDE 0160, Draft 11/94

Overvoltage category, input, output	II
Overvoltage category, input1-input2, Output1-output 2, input-output	III
Contamination class	2

Dimensions and connection data

see page 307

Type	Cat. No.
SMSI 5 AC R	1112260000

Type	Cat. No.
SMSI 5 AC R	1112260000

Technical data

Measurement circuit voltage	10 V...250 Vac
Max. permissible current in measurement circuit	1 A...5 A
Rated consumption ~ (VA)	1 VA (I = 5 A)
Voltage drop at input	< 1 VA (I = 5 A)
Adjustable switching threshold	0.2...2.2 A
Hysteresis between turn-on and turn-off point	≤ approx. 5%
Activation time tA	≤ 45 ms
Reaction time tR	≤ 30 ms
Recovery	< 75 ms
Output voltage	250 V
Max. continuous output current	3 A
Auxiliary voltage	24 Vdc ±10%
Rated consumption auxiliary voltage	1000 mW
Max. switching current	8 A
Contact	1 NO ¹⁾
Contact material	AgNi, gold-plated 3 μm
Storage temperature	-40 °C...+60 °C
Ambient temperature	
- , assembled without spacing on TS	-25 °C...+40 °C
- , assembled with ≥ 20 mm spacing on TS	-25 °C...+50 °C

Coordination of insulation to DIN VDE 0160, Draft 11/94

Overvoltage category, input, output	II
Overvoltage category, input1-input2, Output1-output 2, input-output	III
Contamination class	2

Dimensions and connection data

Fig. V

Voltage Monitoring

- Voltage monitoring from 18 to 299 V
- One and three phase version
- Adjustable switching threshold

SMSU 24 R

SMSU 48 R

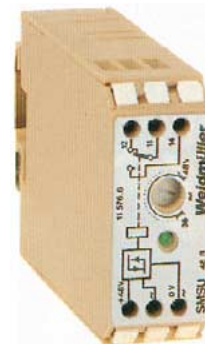

Block diagram/ timing diagram

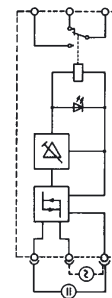
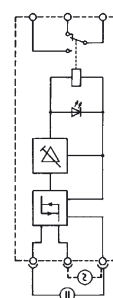
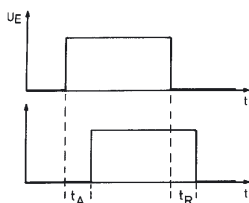

Ordering data

Type	Cat. No.
SMSU 24 R	115760000

Type	Cat. No.
SMSU 48 R	115766000

Technical data

Voltage monitoring range (also Supply voltage)

Rated consumption – (W)
 Rated consumption – (VA)

Adjustable switch-off threshold

Hysteresis/factory setting

Switching points

Activation time t_A

Reaction time t_R

Derating curve

a = assembled without spacing on mounting rail

b = assembled with ≥ 20 mm spacing on mounting rail

18 Vdc...27 Vdc or

18 Vac...27 Vac/50 Hz

< 0.8 W

< 0.9 VA

18 Vuc...24 Vuc

1%...10%/5%

–

< 4 s

< 300 ms

36 Vdc...53 Vdc or

36 Vac...53 Vac/50 Hz

< 1 W

< 1.5 VA

36 Vuc...48 Vuc

1%...10%/5%

–

< 2.5 s

< 300 ms

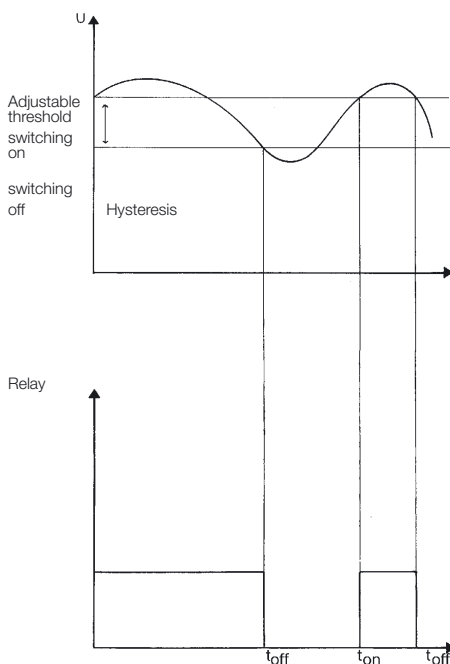

Continuous current

Ambient temperature

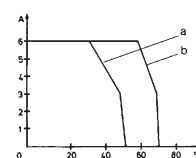
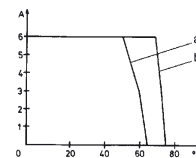

Max. output voltage
 Max. switching current
 Max. continuous output current
 Contact

Contact material
 Switching capacity (resistive load)
 Fuse

Storage temperature

Ambient temperature

–, assembled without spacing on TS

–, assembled with ≥ 20 mm spacing on TS

Coordination of insulation to DIN VDE 0160, Draft 11/94

Overvoltage category, input, input 1-input 2, output

Overvoltage category, input-output, output 1-output 2

Contamination class

Dimensions and connection data see page 306

250 V~
 8 A
 3 A
 1 changeover contact

AgNi 0.15 gold-flashed
 2000 VA

–40 °C...+60 °C

–25 °C...+50 °C

–25 °C...+60 °C

250 V~
 8 A
 3 A
 1 changeover contact

AgNi 0.15 gold-flashed
 2000 VA

–40 °C...+60 °C

–25 °C...+60 °C

–25 °C...+60 °C

SMSU 110 R

SMSU 220 R

SMSU 260 R

SMSU 3x220 R

Three-phase with adjustable switching threshold

SMSU 1-24 DC

Single-phase without switching threshold

SMSU 1-230 AC/DC

Single-phase without adjustable switching threshold

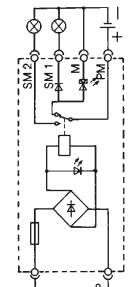
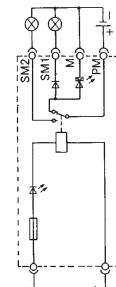
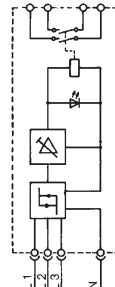
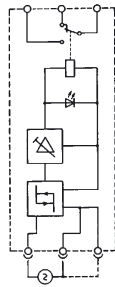
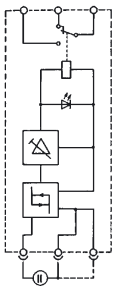
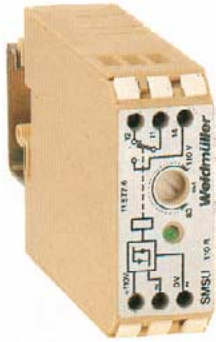

Type	Cat. No.	Type	Cat. No.	Type	Cat. No.	Type	Cat. No.	Type	Cat. No.
SMSU 110 R	1157760000	SMSU 220 R	1157860000	SMSU 260 R	1160160000	SMSU		SMSU 24 DC	0555060000
						3x220 R, 2 NO	1156560000		
						3x220 R, 1 NC/1 NO	1178760000		
83 Vdc...121 Vdc or 83 Vac...121 Vac/50 Hz		165 Vac...253 Vac/50 Hz		200 V...299 Vac/50 Hz		165 V...230 Vac 50 Hz		24 Vdc ± 10%	
< 1.6 W		-		-		-		0.5 W	
< 1.5 W		< 10 VA		< 10 VA		9 VA (L3); 60 mA (L 1/L 2)		-	
83 Vuc...110 Vuc		165 Vac...220 Vac		200 V...260 V		150 V~...205 V~		-	
1%...10%/5%		1%...15%/5%		1%...15%/5%		-7%		-	
-		-		-		-		On: 18.5 V, off: 5 V	
< 4 s		< 3 s		< 3 s		< 4 s		15 ms	
< 300 ms		< 2 s		< 2 s		< 80 ms		10 ms	

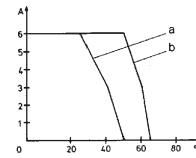
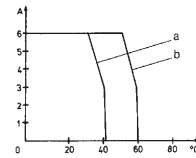
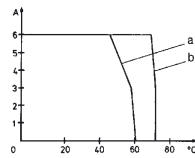
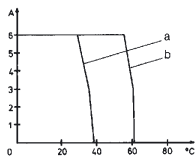

250 V~	250 V~	250 V~	250 V~	24 V- ± 10%	24 V- ± 10%
8 A	8 A	8 A	8 A		
3 A	3 A	3 A	3 A	1 A	1 A
1 changeover contact	1 changeover contact	1 changeover contact	2 NO (115656) 1 NO/1 NC (117876)	1 changeover contact	1 changeover contact
AgNi 0.15 gold-flashed 2000 VA	AgNi 0.15 gold-flashed 2000 VA	AgNi 0.15 gold-flashed 2000 VA	AgCdO, gold-flashed 5x10 ⁷ switching operations 2x10 ⁵ switching operations 10 ⁵ switching operations	AgNi, gold-flashed 10 ⁵ switching operations 100 mA	AgNi, gold-flashed 10 ⁵ switching operations 100 mA
-40 °C...+60 °C	-40 °C...+60 °C	-40 °C...+60 °C	-40 °C...+60 °C	-40 °C...+60 °C	-40 °C...+60 °C
-25 °C...+30 °C	-25 °C...+45 °C	-25 °C...+45 °C	-5 °C...+40 °C	-25 °C...+40 °C	-25 °C...+40 °C
-25 °C...+55 °C	-25 °C...+60 °C	-25 °C...+60 °C	-5 °C...+55 °C	-25 °C...+50 °C	-25 °C...+50 °C
			II		
			III		
			2		

Movement and Rotational Speed Monitoring

SMS SIZA

Rotational speed monitoring



Block diagram

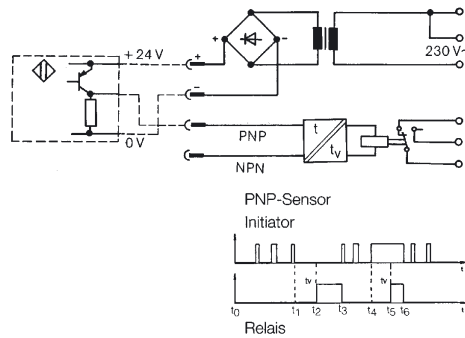

Ordering data

Type	Cat. No.
SMS/SIZA	1110560000

Description

Power supply with delayed turn-off relay output for three-conductor DC initiators (NPN or PNP).

The transformer supplies the initiator with 24 V DC. The initiator signal activates the relay, at which time the adjustable turn-off delay becomes effective. This module is particularly suitable for monitoring cyclic movements, e.g. down-times monitoring of conveyor drives, ventilators and pumps or stroke monitoring of valves, die cutters and drilling heads.

A contact element actuates the initiator at regular intervals. If these pulses cease, i.e. the proximity switch is continuously actuated (t_1-t_2) or deactivated (t_1-t_3), the relay transmits a signal after the set time has elapsed. During normal operation, the time function bridges the gaps between regular pulses (t_0-t_2)

Technical data

Operating voltage	230 Vdc +5 –15%
Initiator type/initiator voltage	P or N switched/24 Vdc
Output voltage	250 V
Continuous current	4 A
Max. switching capacity (resistive load)	2000 VA
Contact	1 changeover contact
Contact material	AgNi 0.15 gold-flashed
Mechanical service life	> 10 ⁷ switching operations
Time range	0.5...5 s

Coordination of insulation to VDE DIN 0160, draft11/94

Rated voltage	300 V
Rated surge voltage	4 kV
Overvoltage category	III
Contamination class	2
Clearance and creepage distance	≥ 3 mm
EMC	EN 50 081-1/50 082-2

Accessories and dimensions see page 307

Fig. VI

Namur Switch Amplifiers

EGV-Namur

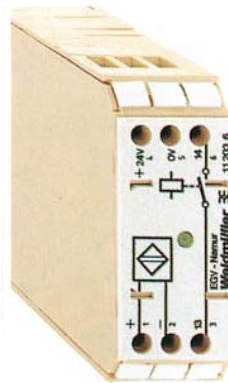

EGV-Inverter

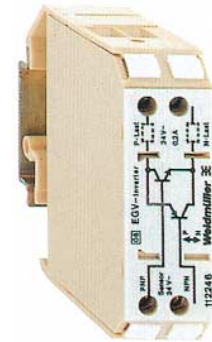

Block diagram

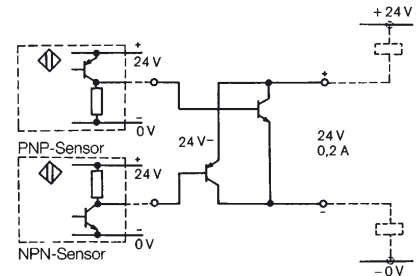
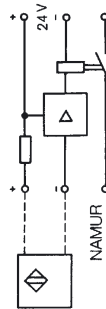

Ordering data

Type	Cat. No.
EGV Namur	1120360000

Type	Cat. No.
EGV Inverter	1122460000

Description

Switching amplifier for 2-wire Namur initiators with relay output. Enables the use of economic Namur initiators with short design lengths. This is particularly valid for areas where initiators are subjected to heavy mechanical stresses, and often need to be replaced. A potential-free NO contact is available on the output side for switching larger ratings (2000 VA). The Namur initiator can be directly connected to the module. LED function indicators indicate switching statuses.

This module inverts the switching function of electronic outputs. A PNP output is changed into an NPN output with the load connected unilaterally against the positive potential (the negative potential is switched through). An NPN output is changed into a PNP output with the load connected unilaterally to the frame potential (the positive potential is switched through). The module reduces the inventory of sensors and electronic switches with PNP/NPN outputs to a single type.

Technical data

Input voltage	24 Vdc $\pm 10\%$
Initiator type/initiator voltage	approx. 8 Vdc
Output voltage, -current	250 Vac/dc
Continuous current	3 A
Max. switching capacity (resistive load)	2000 VA
Contact	1 NO
Contact material	AgNi 0.15 gold-flashed
Mechanical service life	$> 10^7$ switching operations
Ambient temperature	40 °C mounted

24 Vdc $\pm 10\%$ (closed circuit current < 10 mA)
24 Vdc $\pm 10\%$ (switching threshold approx. 15 V)
200 mA

Coordination of insulation to VDE DIN 0160, draft11/94

Rated voltage	300 V
Rated surge voltage	4 kV
Overvoltage category	III
Contamination class	2
Clearance and creepage distance	≥ 3 mm
EMC	EN 50 081, EN 50 082, EN50 011

EN 50 081, EN 50 082, EN50 011

Accessories and dimensions see page 307

Fig. VI

Fig. V

Set Point Generator

EMA/SW 24

- Set point generator
- switchable $-10.5\text{ V}/+10.5\text{ V}$



Set point 1 or set point 2 can be switched to the module's output as required. The changeover is performed safely separated via the control input E1. The output voltage values (0...10.5 V) can be set using the spindle operated potentiometers SW1 and SW2. The control input E* determines the polarity safely separated ($-10.5\text{ V} \dots 0\text{ V} \dots +10\text{ V}$).

Control input E1: 0 V = set point 1, 24 V = set point 2,

Control input E2: 0 V = positive set point, 24 V = negative set point

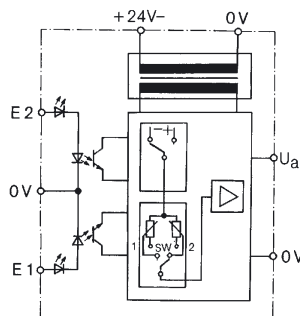

electronic changeover switch

Ordering data	
Type	Cat. No.
EMA/SW	1172660000
Technical data	
Input signal/measurement range	
Control voltage	24 V $\pm 20\%$
Max. input current	$\leq 7\text{ mA}$ at 24 V
Display	each control input: red LED
Setting	via trimming potentiometer 25 rotations nom.
Output signal	
adjustable from $-10.5\text{ V} \dots +10.5\text{ V}$	
Output	Voltage output selection by E1/E2
Output current	max. $\pm 25\text{ mA}$ at $U_{\text{rated}}=24\text{ V}$
Load resistance	min. $400\ \Omega$ at $U_{\text{rated}}=24\text{ V}$
Slew-Rate	0.168 V/ μs
Supply voltage U_B	24 V $\pm 20\%$, 30 mA ($R_L = \infty$)
Residual ripple	30 mV/106 kHz (at U_{max})
Reaction time	rising 50 μs decreasing 80 μs
Isolation voltage, voltage strength	
Input/output/supply	1 kV-
Input-Output/TS	4 kV _{eff}
Storage temperature	$-20\text{ }^\circ\text{C} \dots +70\text{ }^\circ\text{C}$
Operating temperature	0 $^\circ\text{C} \dots +50\text{ }^\circ\text{C}$
Insulation coordination according to EN 50 178	
Overtoltage category	III
Contamination class	2
Accessories, dimensions and connection data see page 307	Fig. V



8-Bit Analogue/Digital Converters

Hold function (H):

The converter can, for example, by means of the hold function (H) be matched to the cycle time of a PLC. Holding and release of the conversion. The Hold input (H) is internally connected to 0 V via a resistor. In order to store the last signal, the Hold input (H) must be supplied with 24 V.

Enable function (E):

The Enable circuit (E) allows several converters, e.g. on an input card of a PLC, to be switched on. The Enable input (E) is connected internally to 0 V via a resistor. In order to make the connection to the PLC, one converter must be disconnected. The other converters are supplied with 24 V (at least 12 V). This causes the converters at the output to be highly resistive.

RS/U-D8



RS/I-D 8



Functions table (example)

Terminal PIN								Digital value/ digital value	Analog voltage Analog voltage
MSB	E8	E7	E6	E5	E4	E3	LSB		
0	0	0	0	0	0	0	0	0	0 V
0	0	0	0	0	0	0	0	1	
0	0	0	0	0	0	0	1	0	
0	0	0	0	0	0	1	1		
-	-	-	-	-	-	-	-	-	
1	1	1	1	1	1	1	0	1	
1	1	1	1	1	1	1	1	0	
1	1	1	1	1	1	1	1	1	+10 V

Block diagram

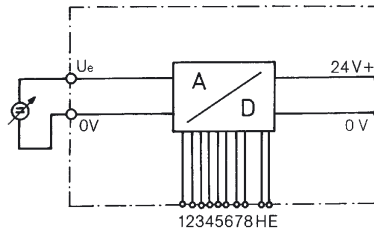

Block diagram

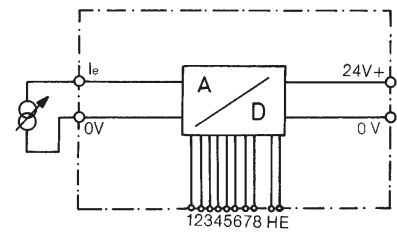

Ordering data

Type	Cat. No.
RS/U-D 8	1122361001

Type	Cat. No.
RS/U-D 8	1160361001

Type	Cat. No.
RS/I-D 8	1160561001

Type	Cat. No.
RS/I-D 8	1168561001

Technical data

Input signal	-10 V...+10 V
Max. input voltage	≤ 55 μA
Max. input current	≥ 200 kΩ
Input resistance	5 kHz at Full-Scale (Sinus) ¹⁾
Max. limit frequency	78 mV c 1 LSB
Resolution	
Output signal	8 Bit (1 Bit prefix)
Output current	≤ 25 mA (as source)
Output level	approx. 17 V c H, 0 V c L
Prefix	MSB: H c positive, L c negative
Transmission error	±1 LSB
Conversion time	≤ 4 μs
Supply	24 V-, ±20 %, 35 mA (plus output current)
Connection arrangement	
	Terminal 1 LSB
	⋮
	Terminal 8 MSB
	Terminal 9 Enable ²⁾
	Terminal 10 Hold
	Hold function:
	High c +24 V c storage of last converted value
	Low c 0 V c free conversion
Storage temperature	-40 °C...+85 °C
Operating temperature	0 °C...+50 °C
EMC EN 50 081-1/50 082-2	

Input signal	0...10 V
Max. input voltage	≤ 25 μA
Max. input current	≥ 400 kΩ
Input resistance	5 kHz at Full-Scale (Sinus) ¹⁾
Max. limit frequency	39 mV c 1 LSB
Resolution	
Output signal	8 Bit
Output current	≤ 25 mA (as source)
Output level	approx. 17 V c H, 0 V c L
Prefix	
Transmission error	±1 LSB
Conversion time	≤ 4 μs
Supply	24 V-, ±20 %, 35 mA (plus output current)
Connection arrangement	
	Terminal 1 LSB
	⋮
	Terminal 8 MSB
	Terminal 9 Enable ²⁾
	Terminal 10 Hold
	Hold function:
	High c +24 V c storage of last converted value
	Low c 0 V c free conversion
Storage temperature	-40 °C...+85 °C
Operating temperature	0 °C...+50 °C

Input signal	0...20 mA
Max. input voltage	3.5 V
Max. input current	25 mA
Input resistance	≥ 51 Ω
Max. limit frequency	5 kHz at Full-Scale (Sinus) ¹⁾
Resolution	78 μA c 1 LSB
Output signal	8 Bit
Output current	≤ 25 mA (as source)
Output level	approx. 17 V c H, 0 V c L
Prefix	
Transmission error	±1 LSB
Conversion time	≤ 4 μs
Supply	24 V-, ±20 %, 35 mA (plus output current)
Connection arrangement	
	Terminal 1 LSB
	⋮
	Terminal 8 MSB
	Terminal 9 Enable ²⁾
	Terminal 10 Hold
	Hold function:
	High c +24 V c storage of last converted value
	Low c 0 V c free conversion
Storage temperature	-40 °C...+85 °C
Operating temperature	0 °C...+50 °C

Input signal	4...20 mA
Max. input voltage	3.5 V
Max. input current	25 mA
Input resistance	≥ 51 Ω
Max. limit frequency	5 kHz at Full-Scale (Sinus) ¹⁾
Resolution	62.5 μA c 1 LSB
Output signal	8 Bit
Output current	≤ 25 mA (as source)
Output level	approx. 17 V c H, 0 V c L
Prefix	
Transmission error	±1 LSB
Conversion time	≤ 4 μs
Supply	24 V-, ±20 %, 35 mA (plus output current)
Connection arrangement	
	Terminal 1 LSB
	⋮
	Terminal 8 MSB
	Terminal 9 Enable ²⁾
	Terminal 10 Hold
	Hold function:
	High c +24 V c storage of last converted value
	Low c 0 V c free conversion
Storage temperature	-40 °C...+85 °C
Operating temperature	0 °C...+50 °C

¹⁾ 1 LSB-Accuracy

²⁾ Enable: 24 V = tristate
0 V = free conversion

8-Bit Digital/Analogue Converters

RS/D 8-U



RS/D 8-I



Block diagram

Pin assignment

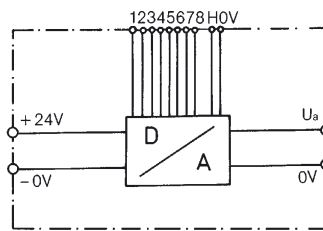

Block diagram

Pin assignment

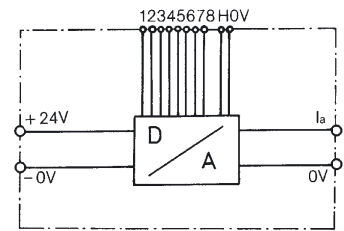

Ordering data	Type	Cat. No.	Type	Cat. No.	Type	Cat. No.	Type	Cat. No.
		RS/D 8-U	1123361001	RS/D 8-U	1160761001	RS/D 8-I	1165861001	RS/D 8-I
Technical data								
Input signal	8 Bit (1 Bit prefix)		8 Bit		8 Bit		8 Bit	
Max. input voltage	5...24 V (typ. 24 V)		5...24 V (typ. 24 V)		5...24 V (typ., max. 30 V) c H		5...24 V (type., max. 30 V) c H	
Max. input current	2.5 mA		2.5 mA		50 kΩ per input		50 kΩ per input	
Input resistance	50 kΩ per input		50 kΩ per input		50 kΩ per input		50 kΩ per input	
Prefix	MSB: H c positive, L c negative							
Resolution	78 mV c 1 LSB		39 mV c 1 LSB		78 μA c 1 LSB		62.5 μA c 1 LSB	
Output signal	-10 V...+10 V		0...10 V		0...20 mA		4...20 mA	
Output current	≤ 10 mA max. current		≤ 10 mA		0...20 mA (as source)		4...20 mA (as source)	
Offset	≤ 20 mV		≤ 20 mV		max. 0.08 mA		4 mA	
Load resistance	≥ 1 kΩ		≥ 1 kΩ		≤ 500 Ω		≤ 500 Ω	
Transmission error	±1 LSB		±1 LSB		±1 LSB		±1 LSB	
Conversion time	≤ 30 μs		≤ 30 μs		≤ 30 μs		≤ 30 μs	
Supply	24 V-, ±20 %, 25 mA (plus output current)		24 V-, ±20 %, 25 mA (plus output current)		24 V-, ±20 %, 25 mA (plus output current)		24 V-, ±20 %, 25 mA (plus output current)	
Connection arrangement	Terminal 1 LSB		Terminal 1 LSB		Terminal 1 LSB		Terminal 1 LSB	
	⋮		⋮		⋮		⋮	
	Terminal 8 MSB		Terminal 8 MSB		Terminal 8 MSB		Terminal 8 MSB	
	Terminal 9 Hold		Terminal 9 Hold		Terminal 9 Hold		Terminal 9 Hold	
	Terminal 10 0 V		Terminal 10 0 V		Terminal 10 0 V		Terminal 10 0 V	
	Hold function:		Hold function:		Hold function:		Hold function:	
	High c +24 V c storage of last converted value		High c +24 V c storage of last converted value		High c +24 V c storage of last converted value		High c +24 V c storage of last converted value	
	Low c 0 V c free conversion		Low c 0 V c free conversion		Low c 0 V c free conversion		Low c 0 V c free conversion	
Storage temperature	-40 °C...+85 °C		-40 °C...+85 °C		-40 °C...+85 °C		-40 °C...+85 °C	
Operating temperature	0 °C...+50 °C		0 °C...+50 °C		0 °C...+50 °C		0 °C...+50 °C	
EMC EN 50 081-1/50 082-2								

12-Bit Analogue/Digital Converters

Hold function (H):

The converter can, for example, by means of the hold function (H) be matched to the cycle time of a PLC. Holding and release of the conversion. The Hold input (H) is internally connected to 0 V via a resistor. In order to store the last signal, the hold input (H) must be supplied with 24 V.

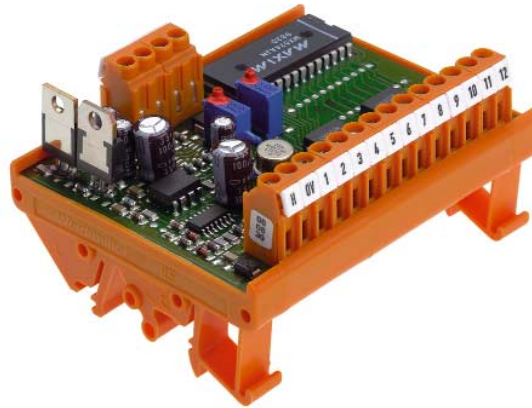

Functions table (example)

Digital value/ digital value	Terminal													
	PIN													
	MSB	12	11	10	9	8	7	6	5	4	3	2	1	LSB
4 mA	0	0	0	0	0	0	0	0	0	0	0	0	0	0
	0	0	0	0	0	0	0	0	0	0	0	0	0	1
	0	0	0	0	0	0	0	0	0	0	0	0	0	1
	0	0	0	0	0	0	0	0	0	0	0	0	0	1
	-	-	-	-	-	-	-	-	-	-	-	-	-	-
	1	1	1	1	1	1	1	1	1	1	1	1	0	1
	1	1	1	1	1	1	1	1	1	1	1	1	1	0
20 mA	1	1	1	1	1	1	1	1	1	1	1	1	1	1

Block diagram

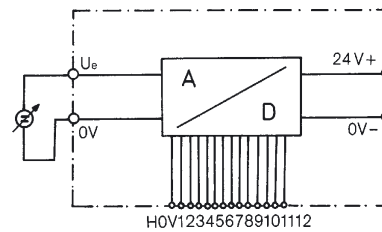

Ordering data

Type	Cat. No.	Type	Cat. No.	Type	Cat. No.	Type	Cat. No.
RS/U-D 12	1168261001	RS/U-D 12	1168361001	RS/I-D 12	1168461001	RS/I-D 12	1169161001

Technical data

Input signal/measurement range	-10...+10 V	0...10 V	0...20 mA	4...20 mA
Max. input voltage	±15 V	15 V		
Max. input current			30 mA	30 mA
Input resistance	100 kΩ	100 kΩ	500 Ω	500 Ω
Prefix	MSB: H c positive, L c negative			
Resolution	4.88 mV c 1 LSB	2.44 mV c 1 LSB	4.9 μA c 1 LSB	4 μA c 1 LSB
Output signal	12 Bit (1 Bit prefix)	12 Bit	12 Bit	12 Bit
Output current	≤ 25 mA (as source)	≤ 25 mA (as source)	≤ 25 mA (as source)	≤ 25 mA (as source)
Output level	24 V c H, 0 V c L	24 V c H, 0 V c L	24 V c H, 0 V c L	24 V c H, 0 V c L
Load resistance				
Transmission error	±1 LSB	±1 LSB	±1 LSB	±1 LSB
Conversion time	≤ 50 μs	≤ 50 μs	≤ 50 μs	≤ 50 μs
Temperature coefficient	1 LSB *	1 LSB *	1 LSB *	1 LSB *
Supply	24 V-, ±20 %	24 V-, ±20 %	24 V-, ±20 %	24 V-, ±20 %
Max. power loss	4 W	4 W	4 W	4 W
Connection arrangement	Terminal 1 LSB : : : Terminal 12 MSB	Terminal 1 LSB : : : Terminal 12 MSB	Terminal 1 LSB : : : Terminal 12 MSB	Terminal 1 LSB : : : Terminal 12 MSB
Hold function:	High c +24 V c storage of digital signal Low c 0 V c enabling the conversion cycle	High c +24 V c storage of digital signal Low c 0 V c enabling the conversion cycle	High c +24 V c storage of digital signal Low c 0 V c enabling the conversion cycle	High c +24 V c storage of digital signal Low c 0 V c enabling the conversion cycle
Storage temperature	-40 °C...+80 °C	-40 °C...+80 °C	-40 °C...+80 °C	-40 °C...+80 °C
Operating temperature	0 °C...+50 °C	0 °C...+50 °C	0 °C...+50 °C	0 °C...+50 °C
EMC EN 50 081-1/50 082-2				

12-Bit Digital/Analogue Converters



Block diagram

Block diagram

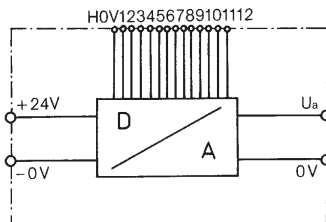

Ordering data	Type	Cat. No.	Type	Cat. No.	Type	Cat. No.	Type	Cat. No.
	RS/D 12-U	1160861001	RS/D 12-U	1166161001	RS/D 12-I	1166061001	RS/D 12-I	1165961001
Technical data								
Input signal/measurement range	12 Bit (1 Bit as prefix)		12 Bit		12 Bit		12 Bit	
Max. input voltage	24 V-, ±20 %		24 V-, ±20 %		24 V-, ±20 %		24 V-, ±20 %	
Input current, I _{nom}	4.2 mA		4.2 mA		4.2 mA		4.2 mA	
Input resistance	5.7 kΩ		5.7 kΩ		5.7 kΩ		5.7 kΩ	
Prefix	MSB: H c positive, L c negative							
Resolution	4.88 mV c 1 LSB		2.44 mV c 1 LSB		4.9 μA c 1 LSB		4 μA c 1 LSB	
Output signal	-10 V...+10 V		0 V...10 V		0...20 mA		4...20 mA	
Output current	≤ 10 mA		≤ 10 mA		0...20 mA (as source)		4...20 mA (as source)	
Output level								
Load resistance	≥ 1 kΩ		≥ 1 kΩ		≤ 500 Ω		≤ 500 Ω	
Transmission error	±1 LSB		±1 LSB		±1 LSB		±1 LSB	
Conversion time	≤ 4 μs		≤ 4 μs		≤ 4 μs		≤ 4 μs	
Temperature coefficient	±100 ppm from FSR/°C		±100 ppm from FSR/°C		±100 ppm from FSR/°C		±100 ppm from FSR/°C	
Supply	24 V-, ±20 %, 40 mA		24 V-, ±20 %, 40 mA		24 V-, ±20 %, 60 mA		24 V-, ±20 %, 60 mA	
Max. power loss								
Connection arrangement	Terminal 1 LSB : : Terminal 12 MSB		Terminal 1 LSB : : Terminal 12 MSB		Terminal 1 LSB : : Terminal 12 MSB		Terminal 1 LSB : : Terminal 12 MSB	
Hold function:	High c +24 V c storage of analogue signal Low c 0 V c enabling the conversion cycle		High c +24 V c storage of analogue signal Low c 0 V c enabling the conversion cycle		High c +24 V c storage of analogue signal Low c 0 V c enabling the conversion cycle		High c +24 V c storage of analogue signal Low c 0 V c enabling the conversion cycle	
Storage temperature	-40 °C...+85 °C		-40 °C...+85 °C		-40 °C...+85 °C		-40 °C...+85 °C	
Operating temperature	0 °C...+50 °C		0 °C...+50 °C		0 °C...+50 °C		0 °C...+50 °C	
EMC EN 50 081-1/50 082-2								

Analogue Signal Processing