

Small Signal Schottky Diodes

Features

- Integrated protection ring against static discharge
- Low capacitance
- Low leakage current
- Low forward voltage drop
- AEC-Q101 qualified
- Compliant to RoHS directive 2002/95/EC and in accordance to WEEE 2002/96/EC

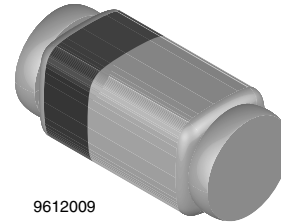

9612009

Applications

- HF-Detector
- Protection circuit
- Diode for low currents with a low supply voltage
- Small battery charger
- Power supplies
- DC / DC converter for notebooks

Mechanical Data

Case: QuadroMELF SOD-80

Weight: approx. 34 mg

Cathode Band Color: Black

Packaging Codes/Options:

GS18 / 10 k per 13" reel (8 mm tape), 10 k/box

GS08 / 2.5 k per 7" reel (8 mm tape), 12.5 k/box

Parts Table

Part	Type differentiation	Ordering code	Remarks
LS101A	$V_R = 60\text{ V}$, V_F at $I_F = 1\text{ mA}$ max. 410 mV	LS101A-GS18 or LS101A-GS08	Tape and Reel
LS101B	$V_R = 50\text{ V}$, V_F at $I_F = 1\text{ mA}$ max. 400 mV	LS101B-GS18 or LS101B-GS08	Tape and Reel
LS101C	$V_R = 40\text{ V}$, V_F at $I_F = 1\text{ mA}$ max. 390 mV	LS101C-GS18 or LS101C-GS08	Tape and Reel

Absolute Maximum Ratings

$T_{amb} = 25\text{ }^\circ\text{C}$, unless otherwise specified

Parameter	Test condition	Part	Symbol	Value	Unit
Reverse voltage		LS101A	V_R	60	V
		LS101B	V_R	50	V
		LS101C	V_R	40	V
Peak forward surge current	$t_p = 10\text{ }\mu\text{s}$		I_{FSM}	2	A
Repetitive peak forward current			I_{FRM}	150	mA
Forward continuous current			I_F	30	mA

Thermal Characteristics

$T_{amb} = 25\text{ }^{\circ}\text{C}$, unless otherwise specified

Parameter	Test condition	Symbol	Value	Unit
Thermal resistance junction to ambient air	on PC board 50 mm x 50 mm x 1.6 mm	R_{thJA}	320	K/W
Junction temperature		T_j	125	$^{\circ}\text{C}$
Storage temperature range		T_{stg}	- 65 to + 150	$^{\circ}\text{C}$

Electrical Characteristics

$T_{amb} = 25\text{ }^{\circ}\text{C}$, unless otherwise specified

Parameter	Test condition	Part	Symbol	Min	Typ.	Max	Unit
Reverse Breakdown Voltage	$I_R = 10\text{ }\mu\text{A}$	LS101A	$V_{(BR)}$	60			V
		LS101B	$V_{(BR)}$	50			V
		LS101C	$V_{(BR)}$	40			V
Leakage current	$V_R = 50\text{ V}$	LS101A	I_R			200	nA
	$V_R = 40\text{ V}$	LS101B	I_R			200	nA
	$V_R = 30\text{ V}$	LS101C	I_R			200	nA
Forward voltage drop	$I_F = 1\text{ mA}$	LS101A	V_F			410	mV
		LS101B	V_F			400	mV
		LS101C	V_F			390	mV
	$I_F = 15\text{ mA}$	LS101A	V_F			1000	mV
		LS101B	V_F			950	mV
		LS101C	V_F			900	mV
Diode capacitance	$V_R = 0\text{ V}, f = 1\text{ MHz}$	LS101A	C_D			2	pF
		LS101B	C_D			2.1	pF
		LS101C	C_D			2.2	pF

Typical Characteristics

$T_{amb} = 25\text{ }^{\circ}\text{C}$, unless otherwise specified

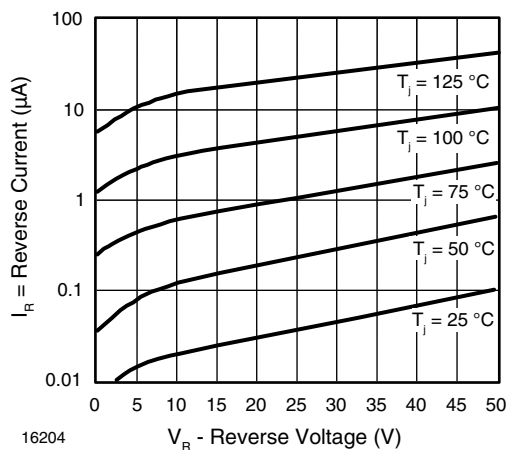

Figure 1. Reverse Current vs. Reverse Voltage

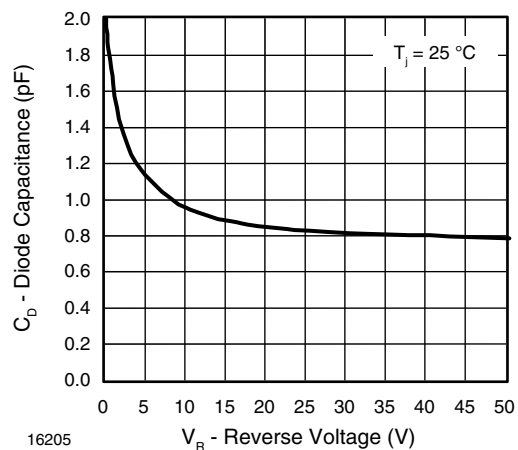

Figure 2. Diode Capacitance vs. Reverse Voltage

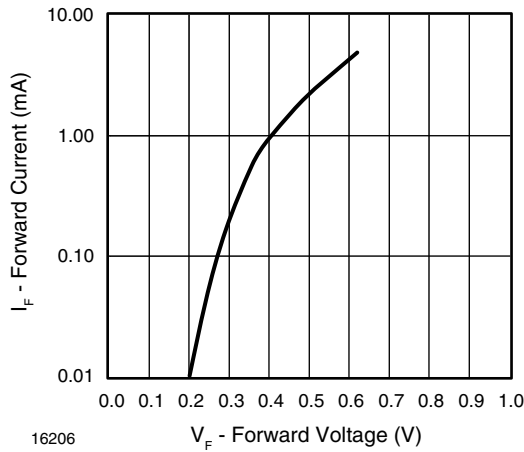
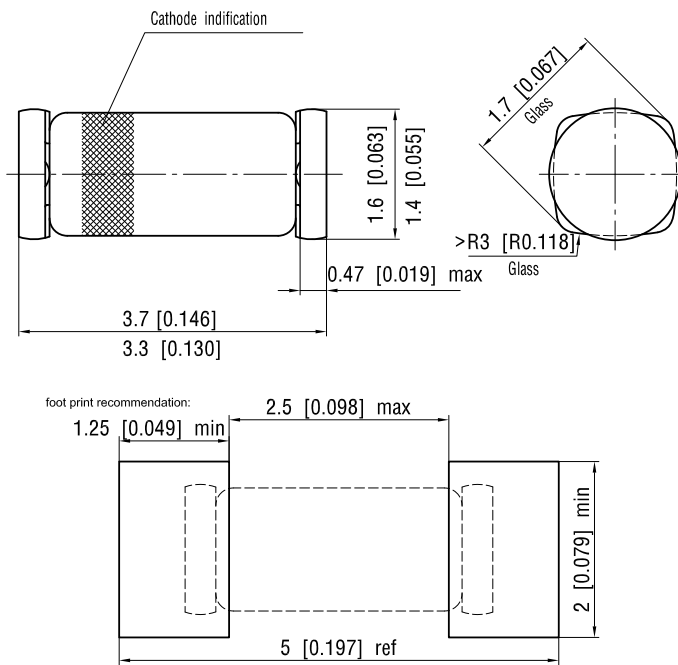
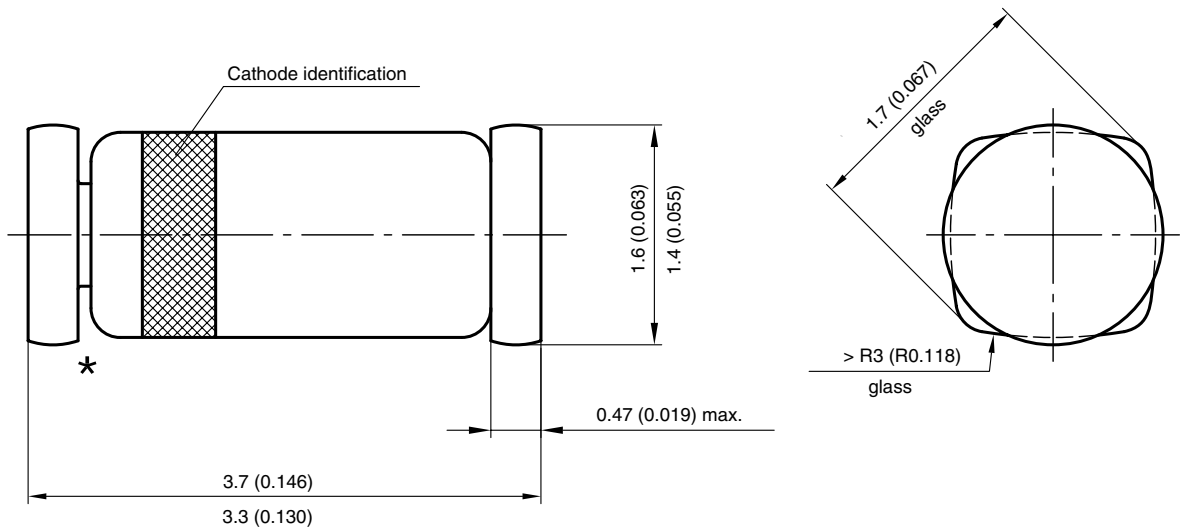

Figure 3. Forward Current vs. Forward Voltage

Package Dimensions in millimeters (inches): QuadroMELF SOD-80



PACKAGE DIMENSIONS in millimeters (inches)



* The gap between plug and glass can be either on cathode or anode side

Foot print recommendation:

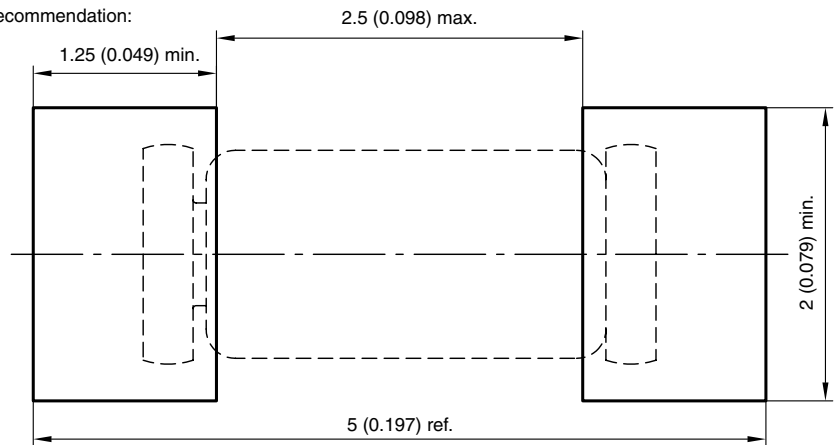

Created - Date: 03.November.2003
 Rev. 11 - Date: 07.June 2006
 Document no.:6.560-5006.01-4
 96 12071



Disclaimer

ALL PRODUCT, PRODUCT SPECIFICATIONS AND DATA ARE SUBJECT TO CHANGE WITHOUT NOTICE TO IMPROVE RELIABILITY, FUNCTION OR DESIGN OR OTHERWISE.

Vishay Intertechnology, Inc., its affiliates, agents, and employees, and all persons acting on its or their behalf (collectively, "Vishay"), disclaim any and all liability for any errors, inaccuracies or incompleteness contained in any datasheet or in any other disclosure relating to any product.

Vishay makes no warranty, representation or guarantee regarding the suitability of the products for any particular purpose or the continuing production of any product. To the maximum extent permitted by applicable law, Vishay disclaims (i) any and all liability arising out of the application or use of any product, (ii) any and all liability, including without limitation special, consequential or incidental damages, and (iii) any and all implied warranties, including warranties of fitness for particular purpose, non-infringement and merchantability.

Statements regarding the suitability of products for certain types of applications are based on Vishay's knowledge of typical requirements that are often placed on Vishay products in generic applications. Such statements are not binding statements about the suitability of products for a particular application. It is the customer's responsibility to validate that a particular product with the properties described in the product specification is suitable for use in a particular application. Parameters provided in datasheets and/or specifications may vary in different applications and performance may vary over time. All operating parameters, including typical parameters, must be validated for each customer application by the customer's technical experts. Product specifications do not expand or otherwise modify Vishay's terms and conditions of purchase, including but not limited to the warranty expressed therein.

Except as expressly indicated in writing, Vishay products are not designed for use in medical, life-saving, or life-sustaining applications or for any other application in which the failure of the Vishay product could result in personal injury or death. Customers using or selling Vishay products not expressly indicated for use in such applications do so at their own risk and agree to fully indemnify and hold Vishay and its distributors harmless from and against any and all claims, liabilities, expenses and damages arising or resulting in connection with such use or sale, including attorneys fees, even if such claim alleges that Vishay or its distributor was negligent regarding the design or manufacture of the part. Please contact authorized Vishay personnel to obtain written terms and conditions regarding products designed for such applications.

No license, express or implied, by estoppel or otherwise, to any intellectual property rights is granted by this document or by any conduct of Vishay. Product names and markings noted herein may be trademarks of their respective owners.