



# TGA2237-SM

## 0.03–2.5 GHz 10 W GaN Power Amplifier

### Product Overview

Qorvo's TGA2237-SM is a wideband distributed amplifier fabricated on Qorvo's production 0.25 um GaN on SiC process. The TGA2237-SM operates from 0.03–2.5 GHz and provides greater than 10 W of saturated output power with greater than 13 dB of large signal gain and greater than 50% power-added efficiency.

The TGA2237-SM is available in a low-cost, surface mount 32 lead 5 x 5 AIN QFN. It is ideally suited to support both radar and communication applications across defense and commercial markets as well as electronic warfare. The TGA2237-SM is fully matched to 50Ω at both RF ports allowing for simple system integration. DC blocks are required on both RF ports and the drain voltage must be injected through an off chip bias-tee on the RF output port.

Lead-free and RoHS compliant.

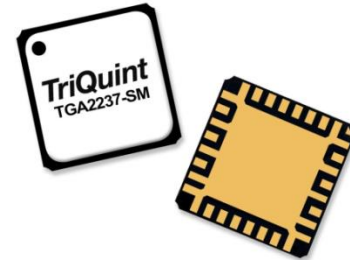

### Key Features

- Frequency Range: 0.03–2.5 GHz
- $P_{SAT}$ : >40 dBm at  $P_{IN} = 27$  dBm
- P1 dB: >33 dBm
- PAE: >50%
- Large Signal Gain: >13 dB
- Small Signal Gain: >19 dB
- Input Return Loss: >10 dB
- Output Return Loss: >12 dB
- Bias:  $V_D = 32$  V,  $I_{DQ} = 360$  mA
- Wideband Flat Power
- Package Dimensions: 5.0 x 5.0 x 1.45 mm

### Functional Block Diagram

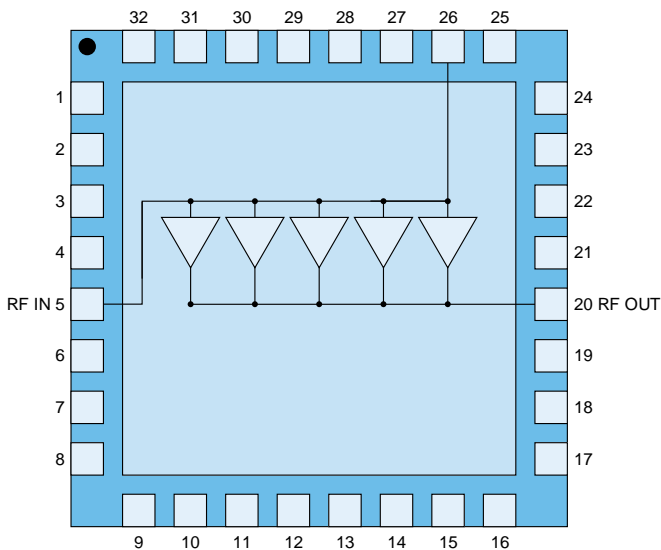

### Applications

- Commercial and Military Radar
- Communications
- Electronic Warfare

### Ordering Information

Part No.	Description
TGA2237-SM	0.03–2.5 GHz 10 W GaN Power Amplifier
TGA2237-SM EVB	Evaluation Board



# TGA2237-SM

## 0.03–2.5 GHz 10 W GaN Power Amplifier

### Absolute Maximum Ratings

Parameter	Value/Range
Drain Voltage ( $V_D$ )	40 V
Gate Voltage Range ( $V_G$ )	-8 to 0 V
Drain Current ( $I_D$ )	1.2 A
Gate Current ( $I_G$ )	-2.4 to 8.4 mA
Power Dissipation ( $P_{DISS}$ ), 85 °C	19 W
Input Power ( $P_{IN}$ ), CW, 50 $\Omega$ , 85 °C	33 dBm <sup>(*)</sup>
Input Power ( $P_{IN}$ ), CW, VSWR 3:1, $V_D = 32V$ , 85 °C	33 dBm <sup>(*)</sup>
Max VSWR, CW, $P_{IN} = 27$ dBm, $V_D = 32$ V, 85 °C (Load)	10:1
Mounting Temperature (30 Seconds)	260 °C
Storage Temperature	-55 to 150 °C

Operation of this device outside the parameter ranges given above may cause permanent damage. These are stress ratings only, and functional operation of the device at these conditions is not implied

### Recommended Operating Conditions

Parameter	Value/Range
Drain Voltage ( $V_D$ )	32 V
Drain Current ( $I_{DQ}$ )	360 mA

Electrical specifications are measured at specified test conditions. Specifications are not guaranteed over all recommended operating conditions.

<sup>(\*)</sup> Operational input power must be limited to 26 dBm when operating below 0.6 GHz to prevent excessive forward gate current.



# TGA2237-SM 0.03–2.5 GHz 10 W GaN Power Amplifier

## Electrical Specifications

Test conditions unless otherwise noted: 25 °C,  $V_D = 32$  V,  $I_{DQ} = 360$  mA

Parameter	Min	Typical	Max	Units
Operational Frequency Range	0.03		2.5	GHz
Small Signal Gain		>19		dB
Input Return Loss		>10		dB
Output Return Loss		>12		dB
Output Power ( $P_{IN} = 27$ dBm)		>40		dBm
Power Added Efficiency ( $P_{IN} = 27$ dBm)		>50		%
Power @ 1 dB Compression (P1 dB)		>33		dBm
IM3 @ POUT/tone = 30 dBm		-25		dBc
IM5 @ POUT/tone = 30 dBm		-33		dBc
Small Signal Gain Temperature Coefficient		-0.03		dB/°C
Output Power Temperature Coefficient		-0.002		dBm/°C
Recommended Operating Voltage:	20	32		V
Gate Leakage ( $V_D = 10$ V, $V_G = -3.7$ V)	-2.64			mA

**Typical Performance: Small Signal**

The plots reflect performance measured with an external coaxial bias tee and DC blocks  
 (See application circuit on page 11)

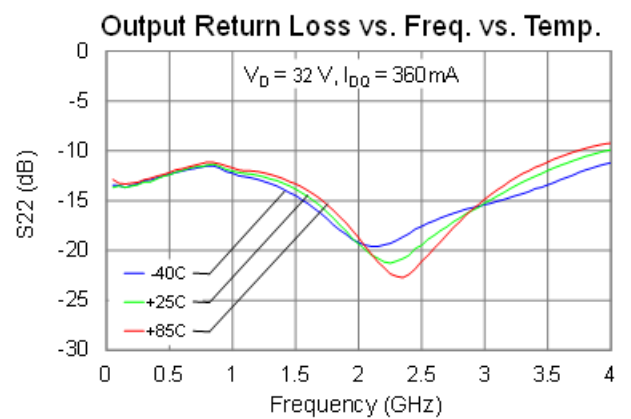
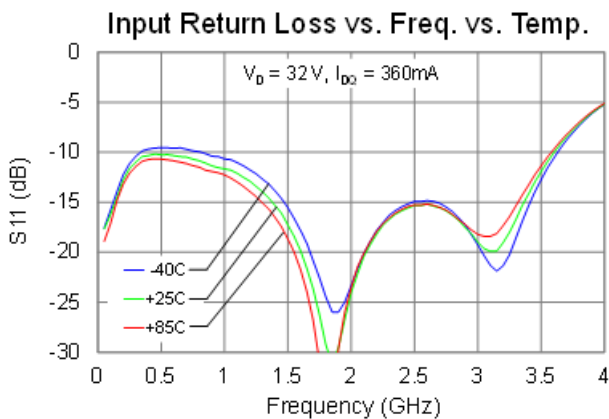
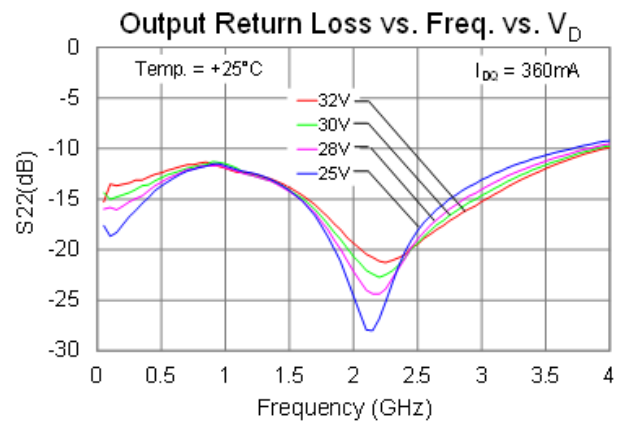
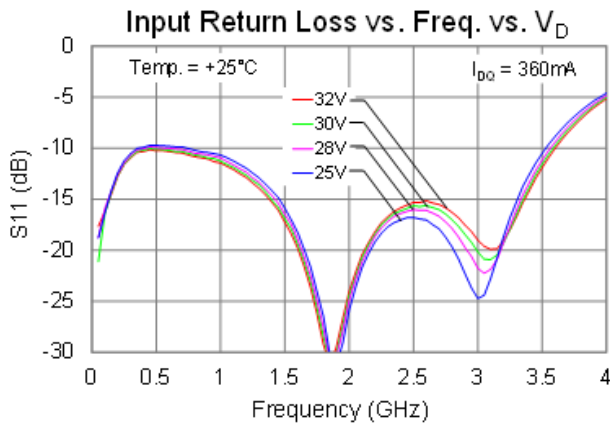
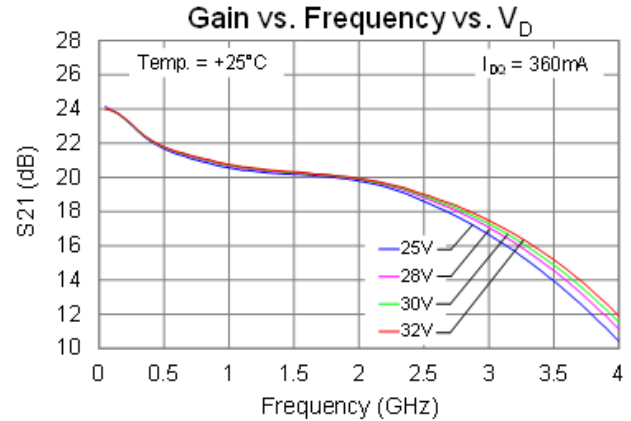
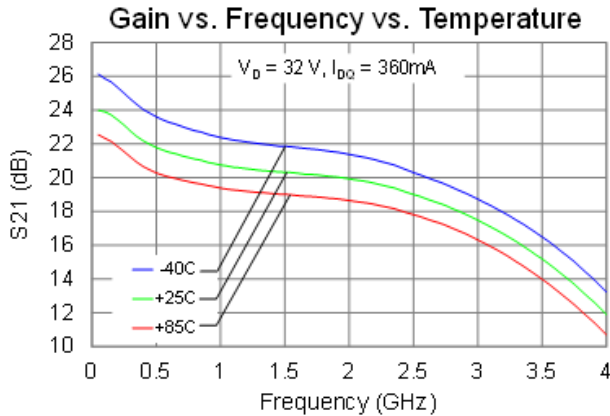

Typical Performance: Large Signal (CW)

The plots reflect performance measured with an external coaxial bias tee and DC blocks  
(See application circuit on page 11)

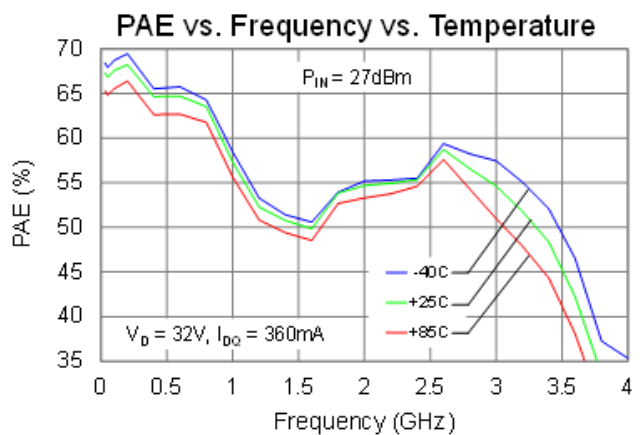
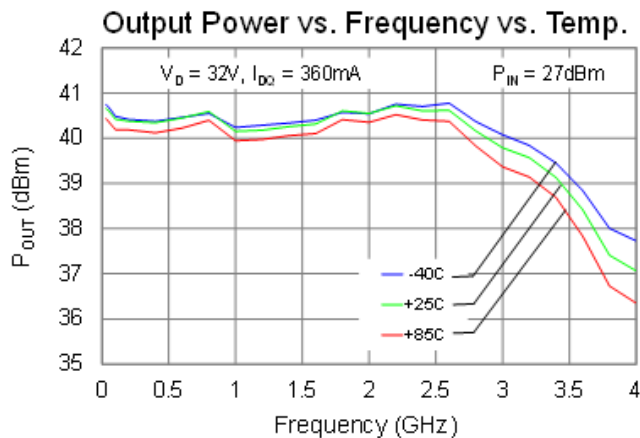
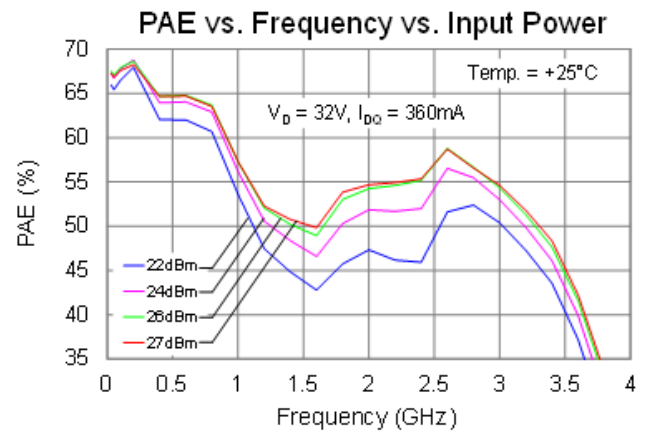
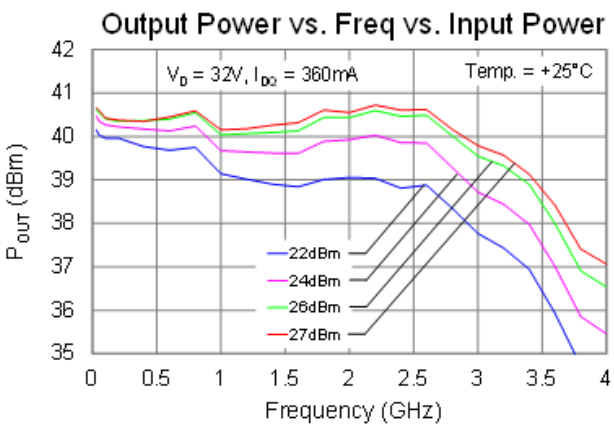
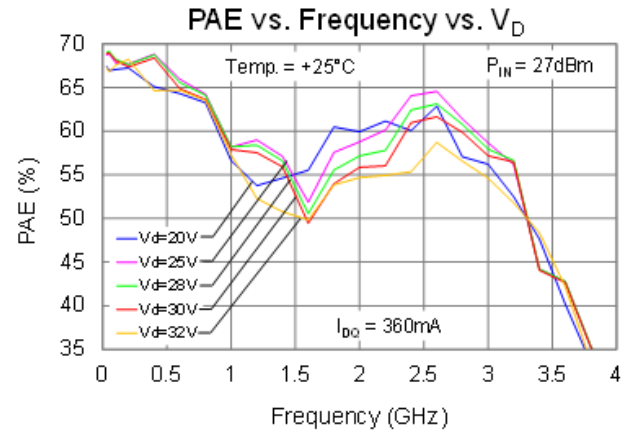
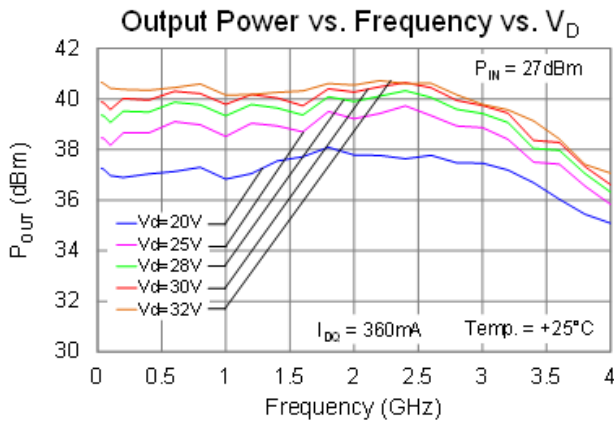

Typical Performance: Large signal (CW)

The plots reflect performance measured with an external coaxial bias tee and DC blocks  
(See application circuit on page 11)

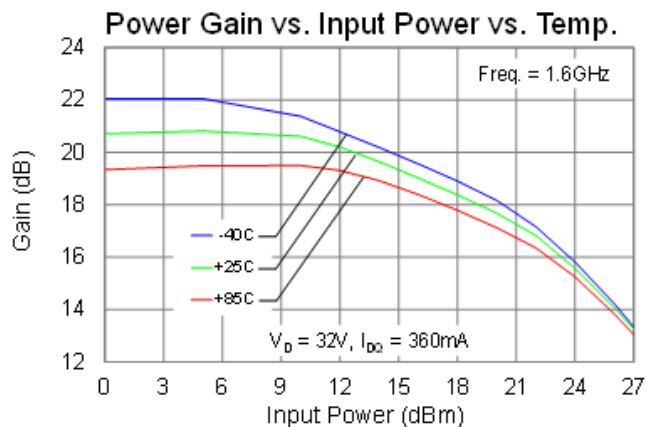
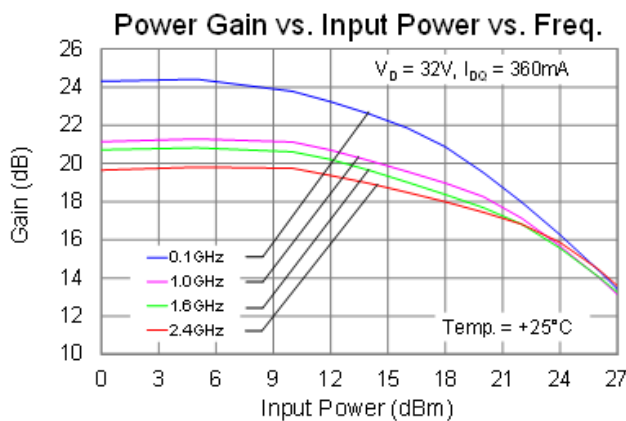
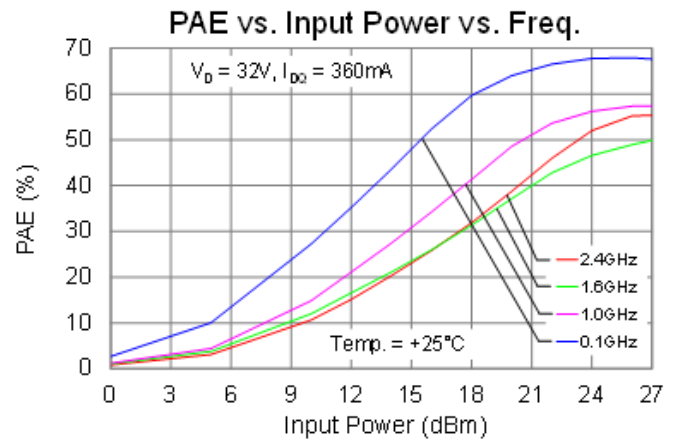
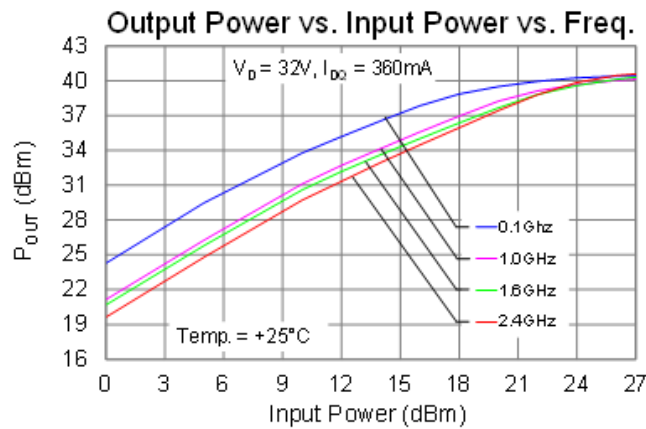
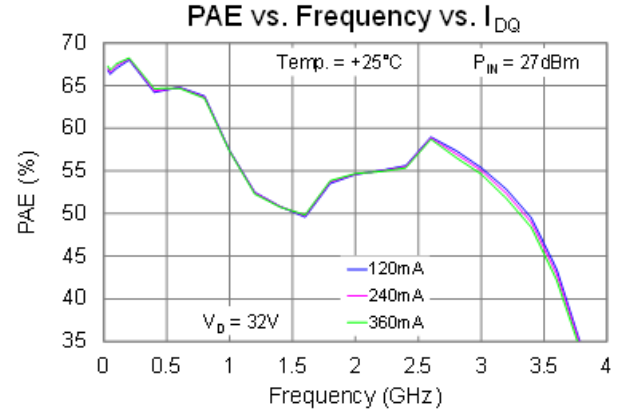
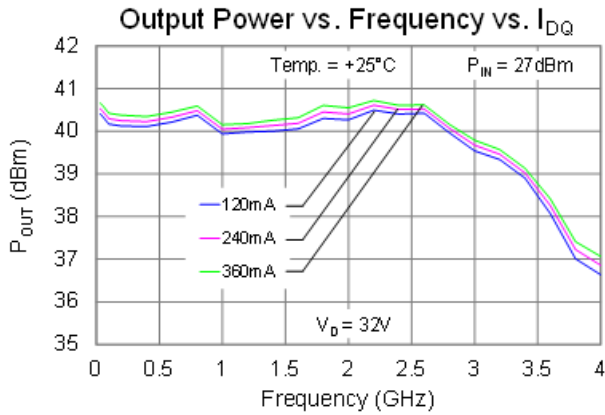

Typical Performance: Large signal (CW)

The plots reflect performance measured with an external coaxial bias tee and DC blocks  
(See application circuit on page 11)

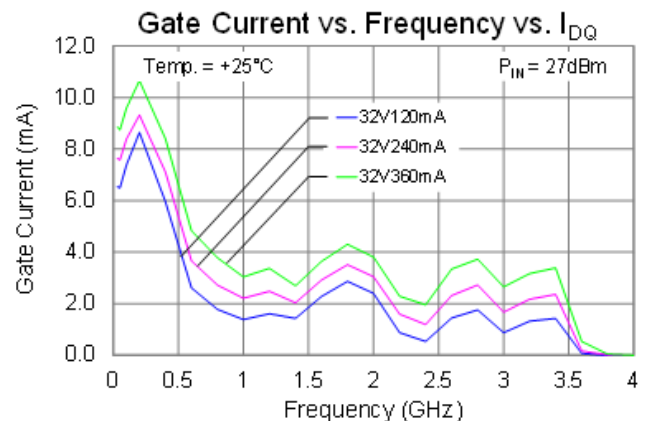
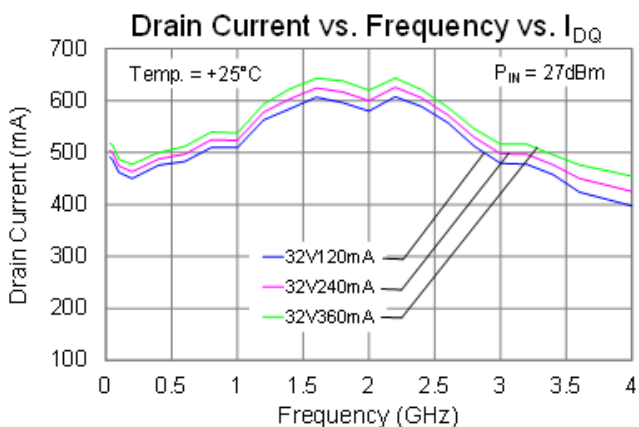
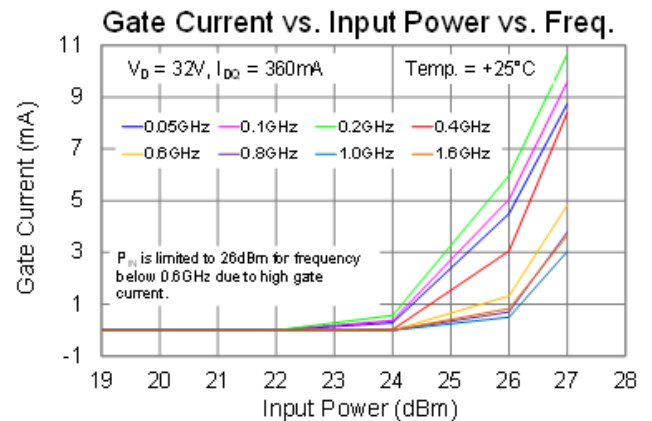
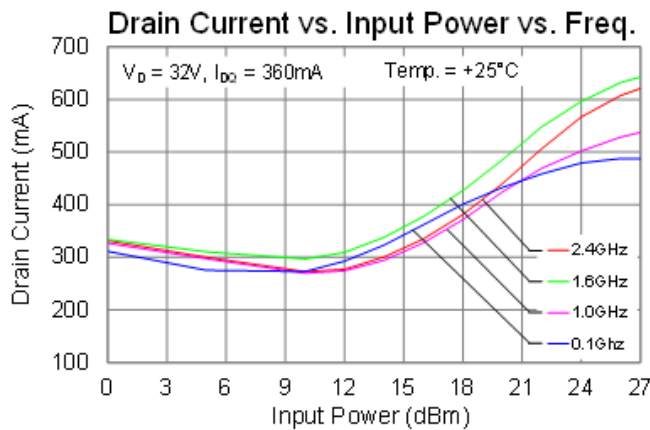
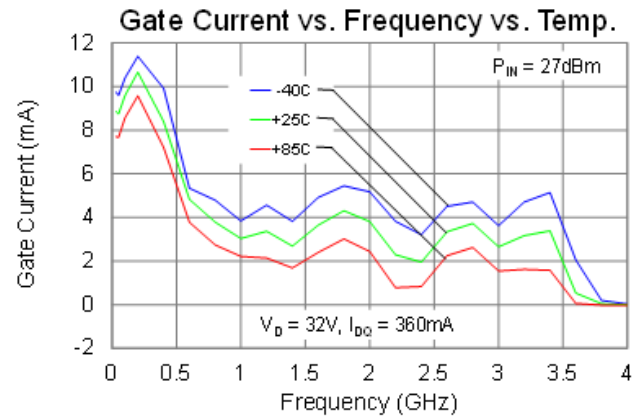
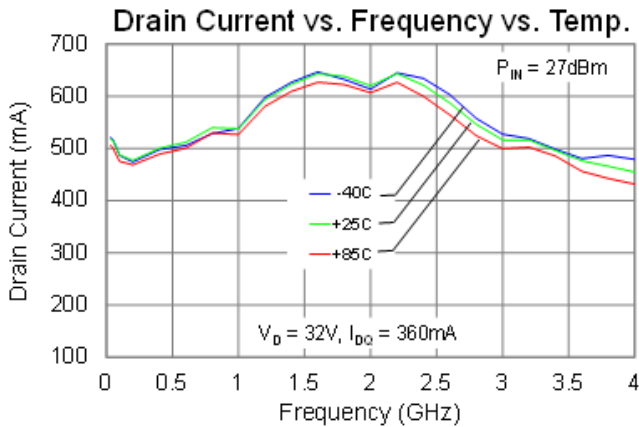

Typical Performance: Linearity

The plots reflect performance measured with an external coaxial bias tee and DC blocks  
(See application circuit on page 11)

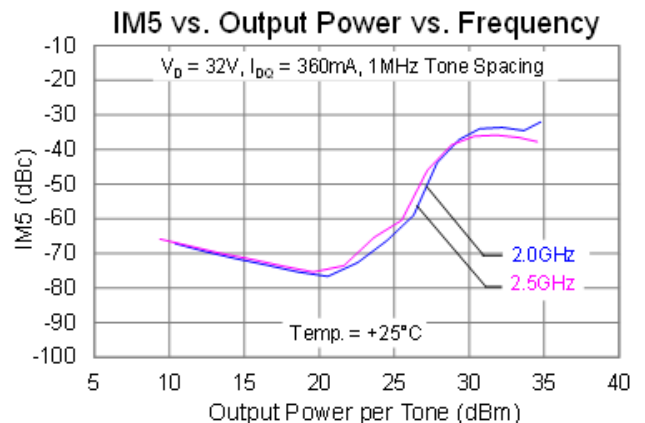
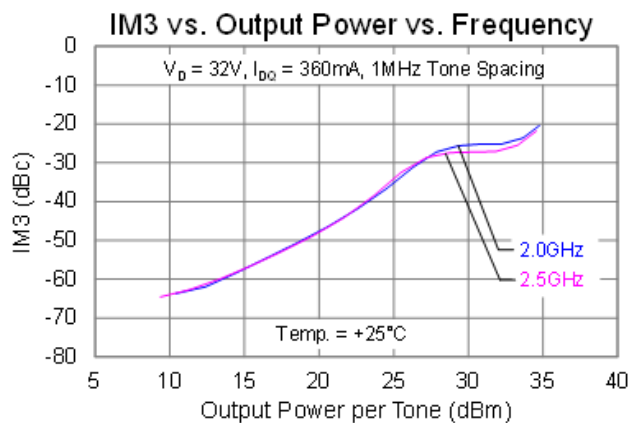
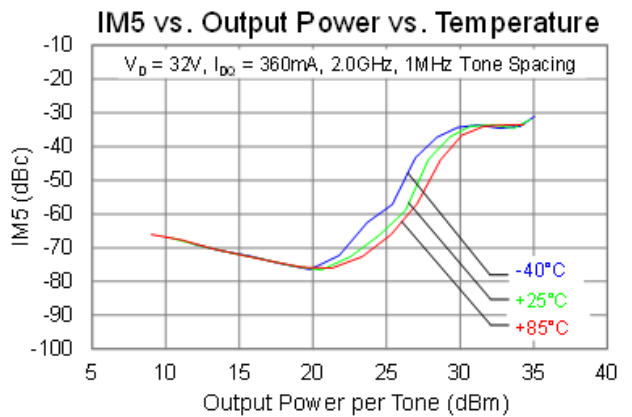
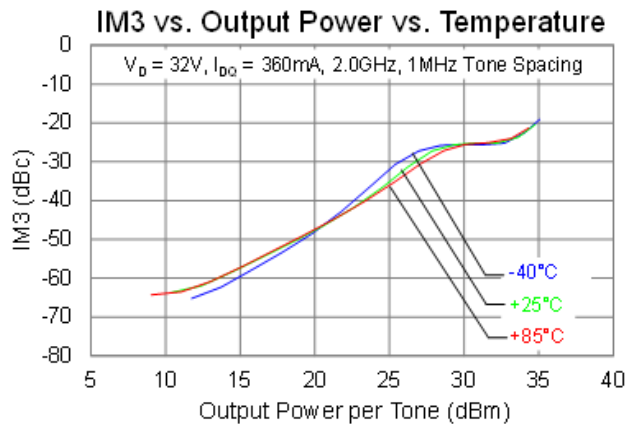
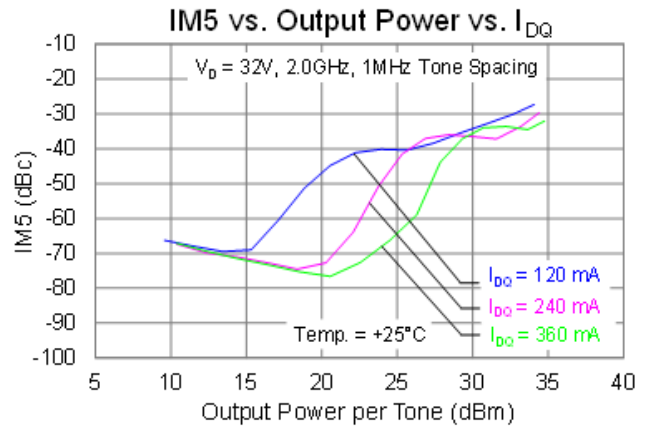
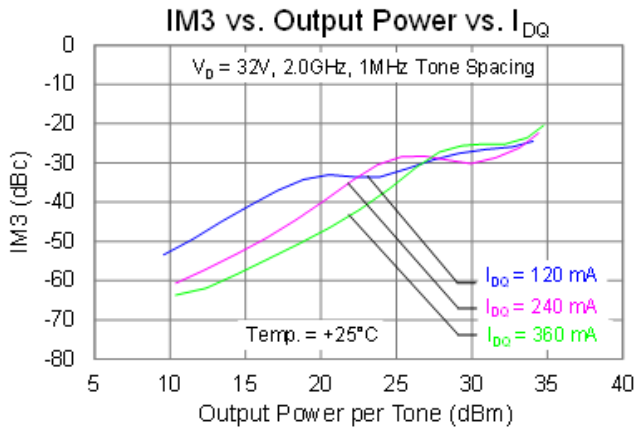



Typical Performance: Linearity

The plots reflect performance measured with an external coaxial bias tee and DC blocks  
(See application circuit on page 11)

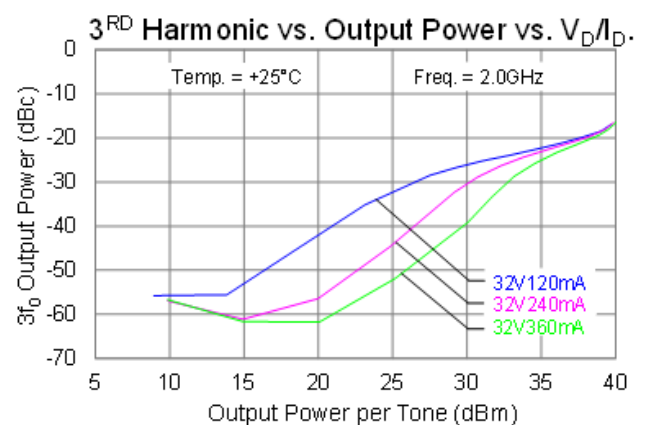
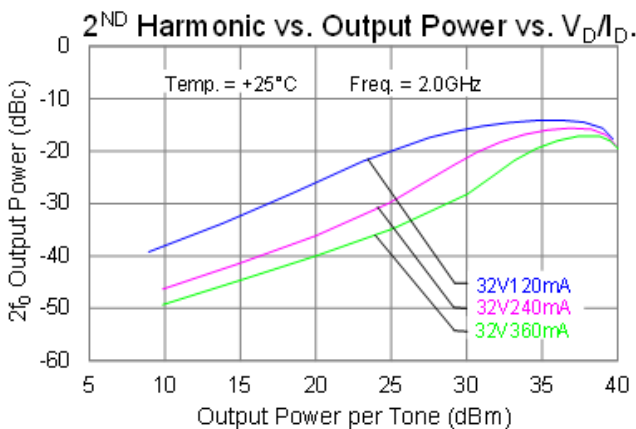
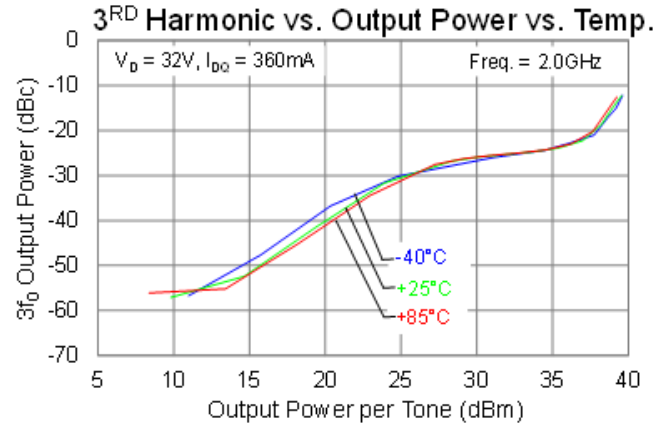
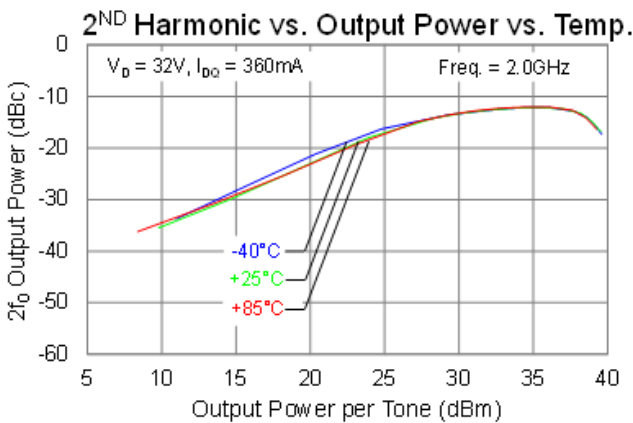
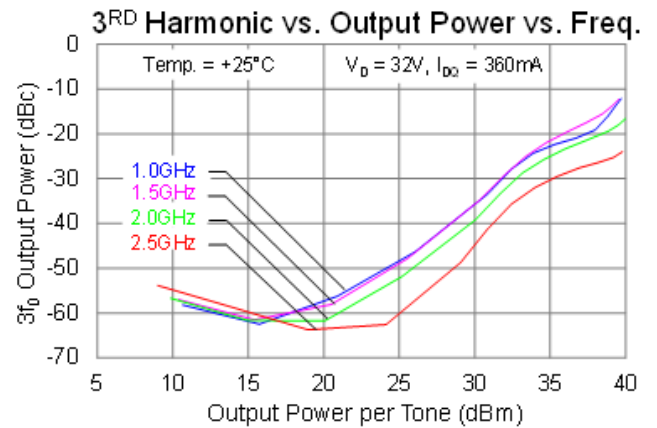
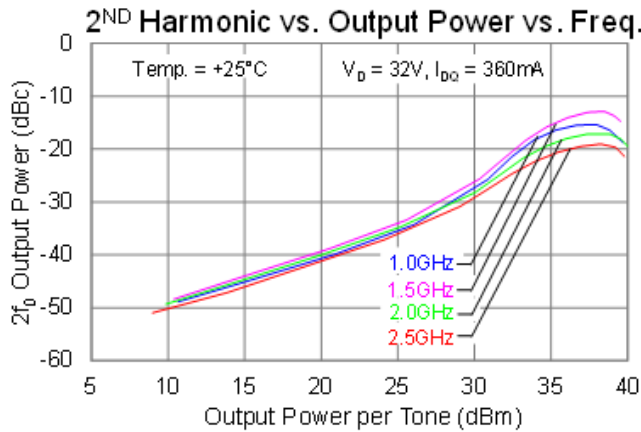

**Typical Performance: Large Signal (CW), On-board vs. External Coaxial Bias-T**

The plots below reflect performance measured between external bias tee and on-board bias tee  
(See application circuit on pages 11 and 13)

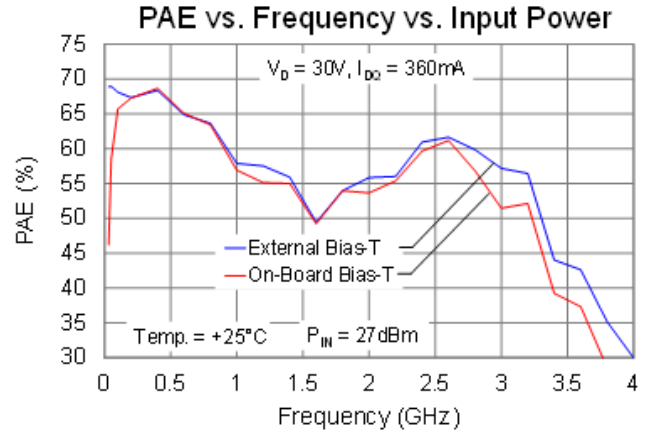
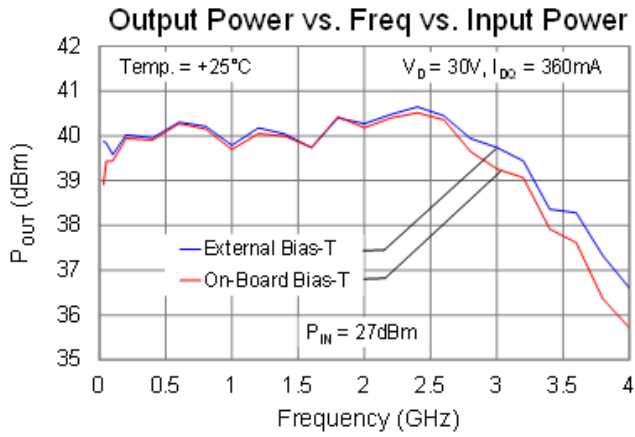

**Thermal and Reliability Information**

Parameter	Test Conditions	Value	Units
Thermal Resistance ( $\theta_{JC}$ ) <sup>(1)</sup>	T <sub>base</sub> = 85 °C, V <sub>D</sub> = 32 V, I <sub>DQ</sub> = 360 mA, I <sub>D_Drive</sub> = 630 mA, P <sub>IN</sub> = 27 dBm, P <sub>OUT</sub> = 40 dBm, P <sub>DISS</sub> = 10 W	6.79	°C/W
Channel Temperature (T <sub>CH</sub> ) (Under RF drive) <sup>(2)</sup>		152.9	°C

Notes:

1. Thermal resistance measured to back of package.
2. Refer to the following document: [GaN Device Channel Temperature, Thermal Resistance, and Reliability Estimates](#)

**Power Dissipation**

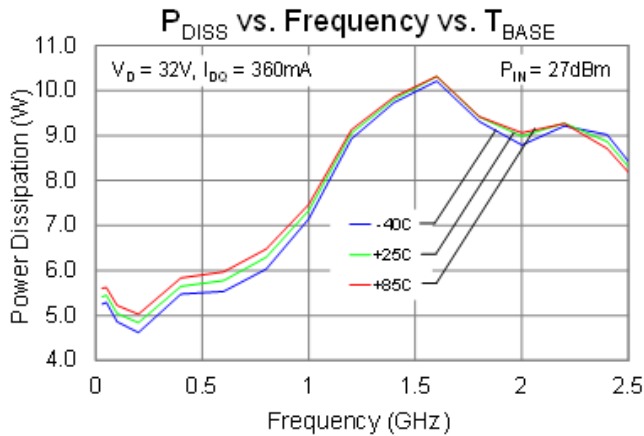

Application Circuit (Coaxial input DC block and coaxial output bias tee)

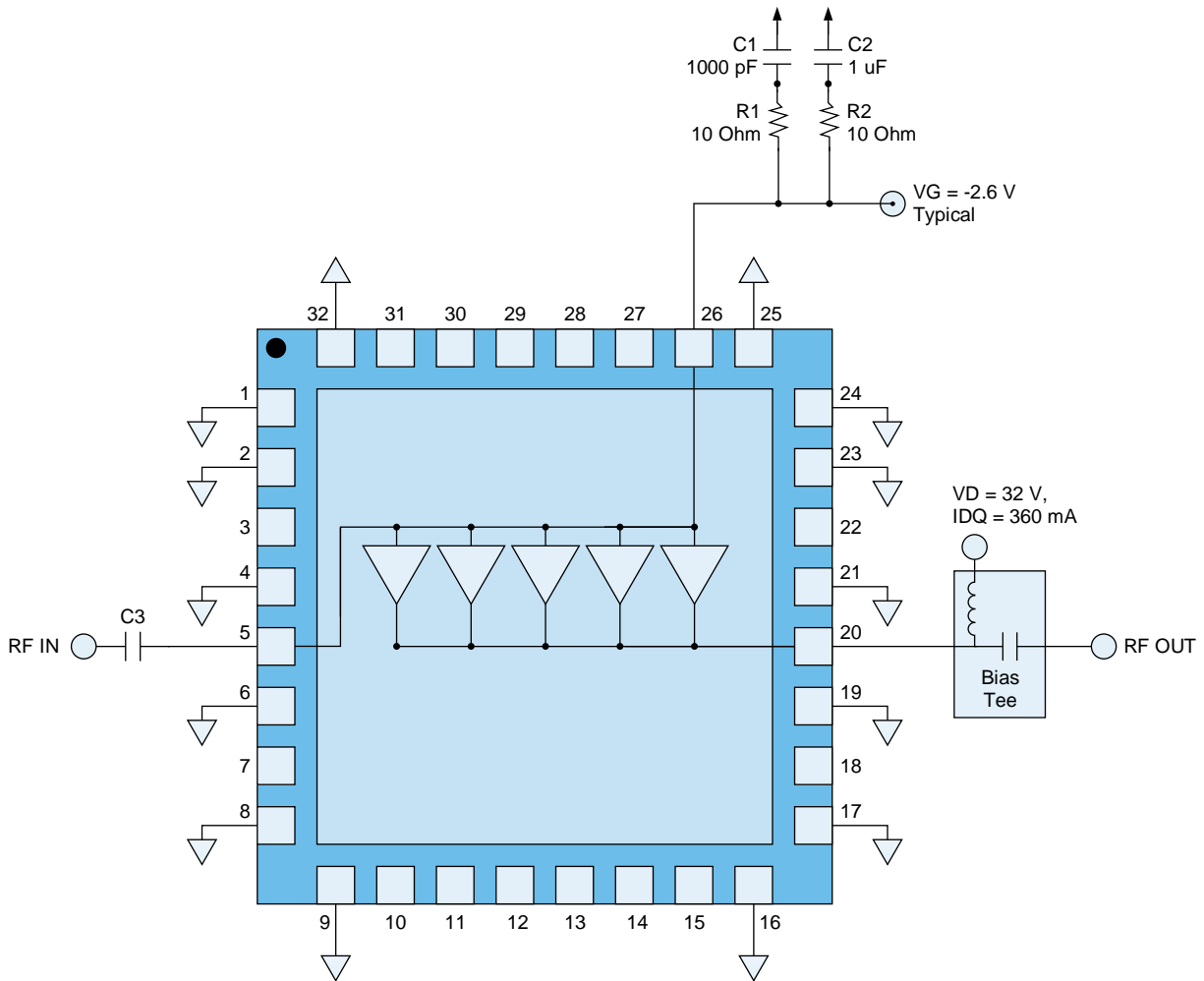

Notes:

1. Coaxial input DC block (C3) is used for input port (RF In.)
2. External wide bandwidth Bias-Tee is used for output port (RF Out).  $V_D$  is applied through the output Bias-Tee.

Bias-up Procedure

1. Set  $I_D$  limit to 700 mA,  $I_G$  limit to 7 mA
2. Set  $V_G$  to -5.0 V
3. Set  $V_D$  +32 V
4. Adjust  $V_G$  more positive until  $I_{DQ} = 360$  mA ( $V_G \sim -2.6$  V Typical)
5. Apply RF signal \*

Bias-down Procedure

1. Turn off RF signal
2. Reduce  $V_G$  to -5.0 V. Ensure  $I_{DQ} \sim 0$  mA
3. Set  $V_D$  to 0 V
4. Turn off  $V_D$  supply
5. Turn off  $V_G$  supply

(\*)  $P_{IN}$  is limited to 26 dBm for frequency < 0.6 GHz due to high gate current.

Assembly Drawing (Coaxial input DC block and coaxial output bias tee)

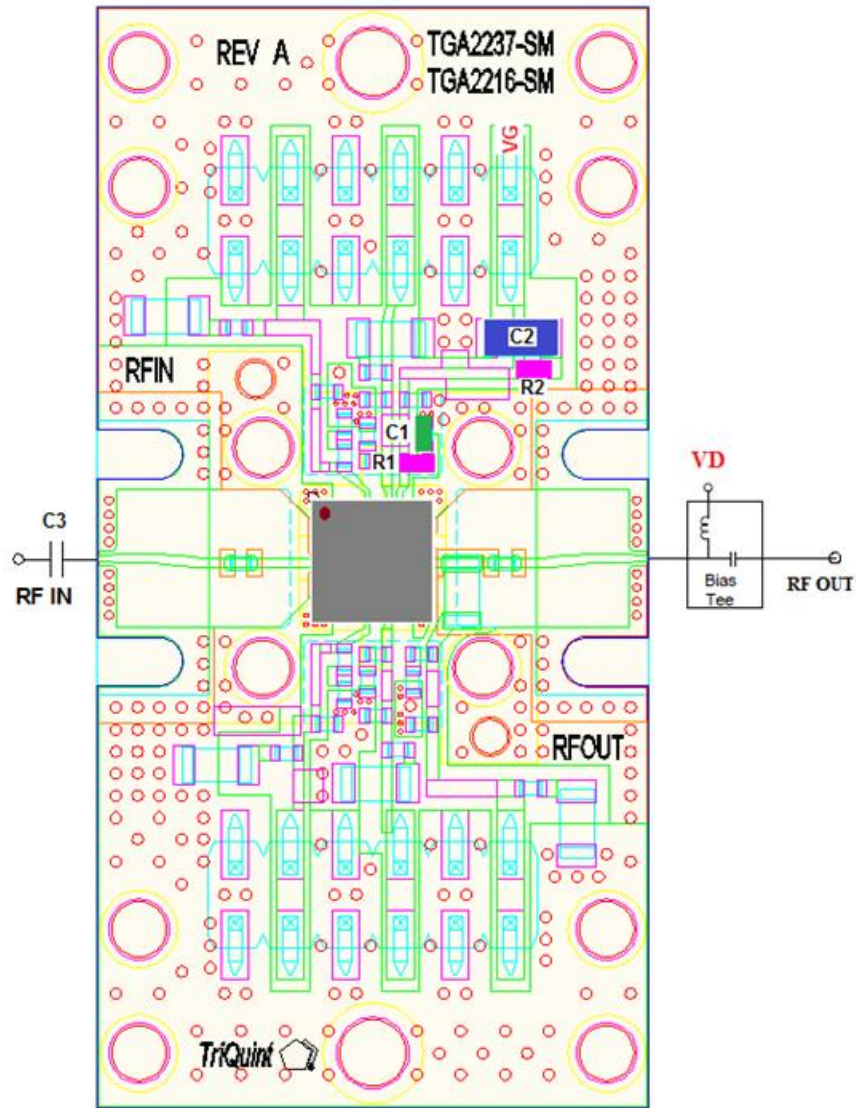

Bill of Materials

Reference Designator	Value	Description	Manufacturer	Part Number
C1	1000 pF	Cap, 0402, 100 V, 10%, X7R	Various	
C2	1 uF	Cap, 1206, 50 V, 10%, X7R	Various	
C3	1000 pF	DC Block	Various	
R1 – R2	10 Ω	Res, 0402	Various	

Application Circuit (Option with board-level DC blocks and output bias tee)

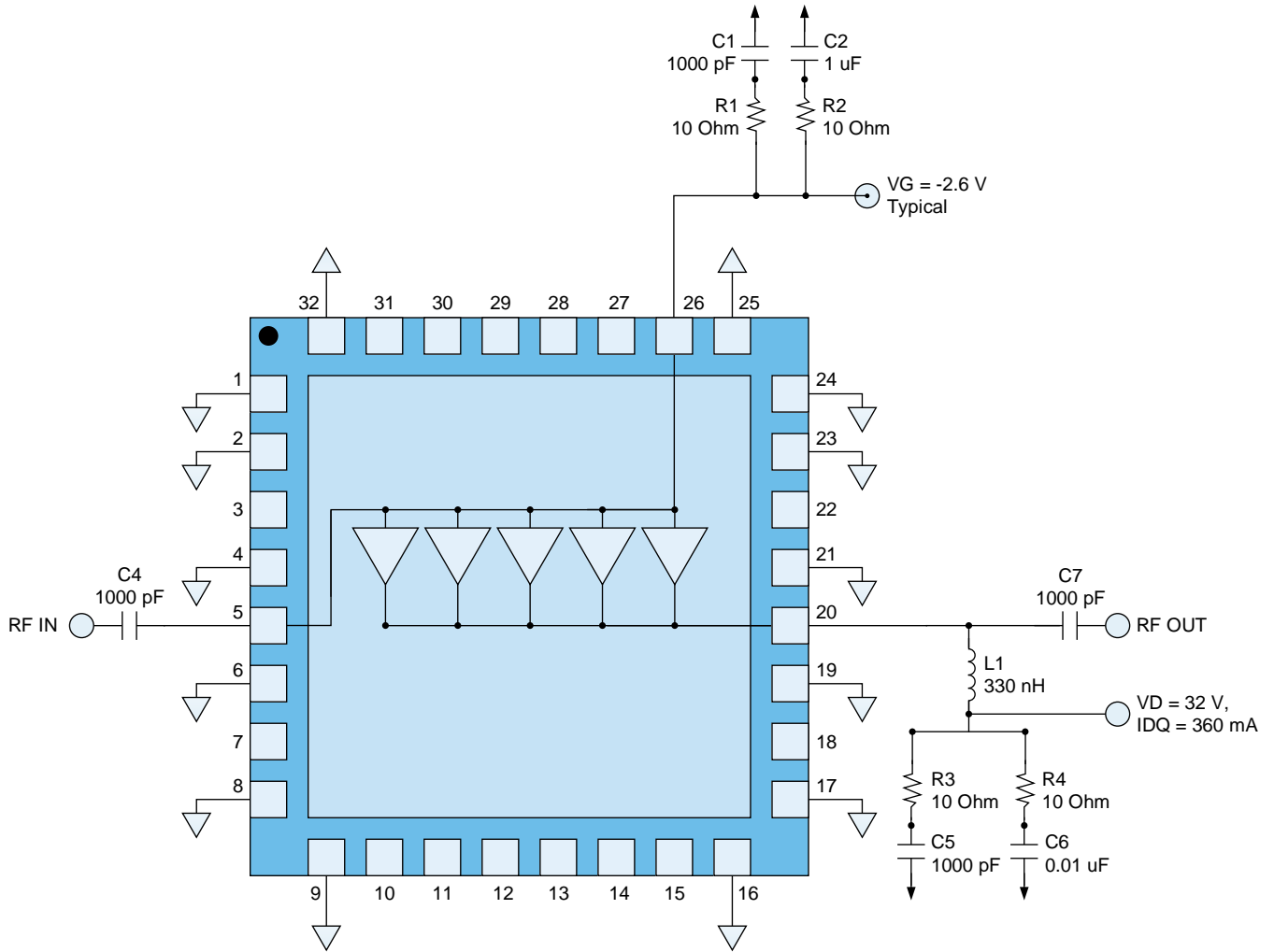

Notes:

1. Performance of the DUT with surface mount DC blocks and bias tee components may be degraded relative to the coaxial option. These components should be optimized for the desired operational bandwidth.

Evaluation Board Layout with On-Board DC Blocks and Output Bias-T Option

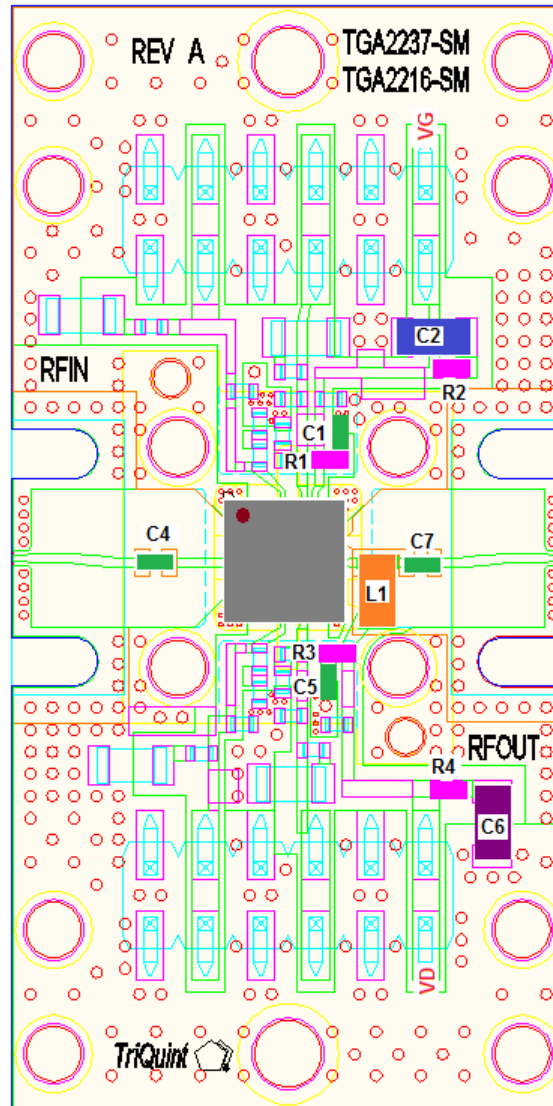

Bill of Materials For On-Board Bias-Tee

Reference Designator	Value	Description	Manufacturer	Part Number
C1, C4, C5, C7	1000 pF	Cap, 0402, 100 V, 10%, X7R	Various	
C2	1 uF	Cap, 1206, 50 V, 10%, X7R	Various	
C6	0.01 uF	Cap, 1206, 100 V, 10%, X7R	Various	
L1	330 nH	Ind, 1206, 100 V, 10%, X7R	Various	
R1 – R4	10 Ω	Res, 0402	Various	

## Pin Layout

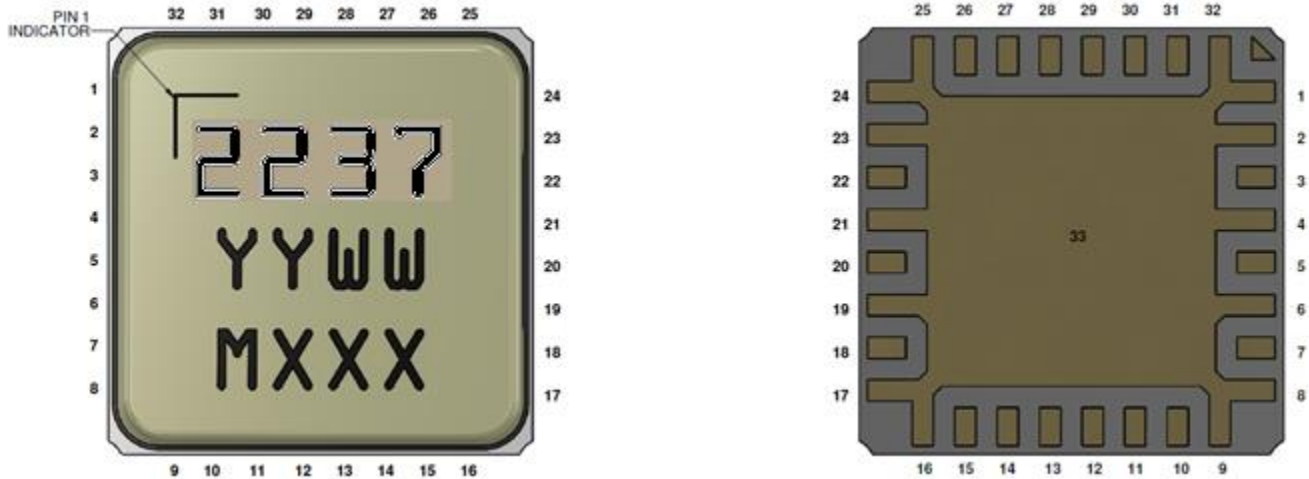

## Pin Description

Pin No.	Symbol	Description
1-2, 4, 6, 8-9, 16-17, 19, 21, 23-25, 32	GND	Connected to ground paddle (pin 33); must be grounded on PCB.
3, 7, 10-15, 18, 22, 27-31	NC	No connection.
5	RF IN	Input; matched to 50 Ω.
20	RF OUT/ DRAIN	Output; matched to 50 Ω.
26	GATE	GATE voltage; bias network is required; see recommended Application Information on page 11.
33	GND	Ground Paddle. Multiple vias should be employed to minimize inductance and thermal resistance.



Mechanical Information

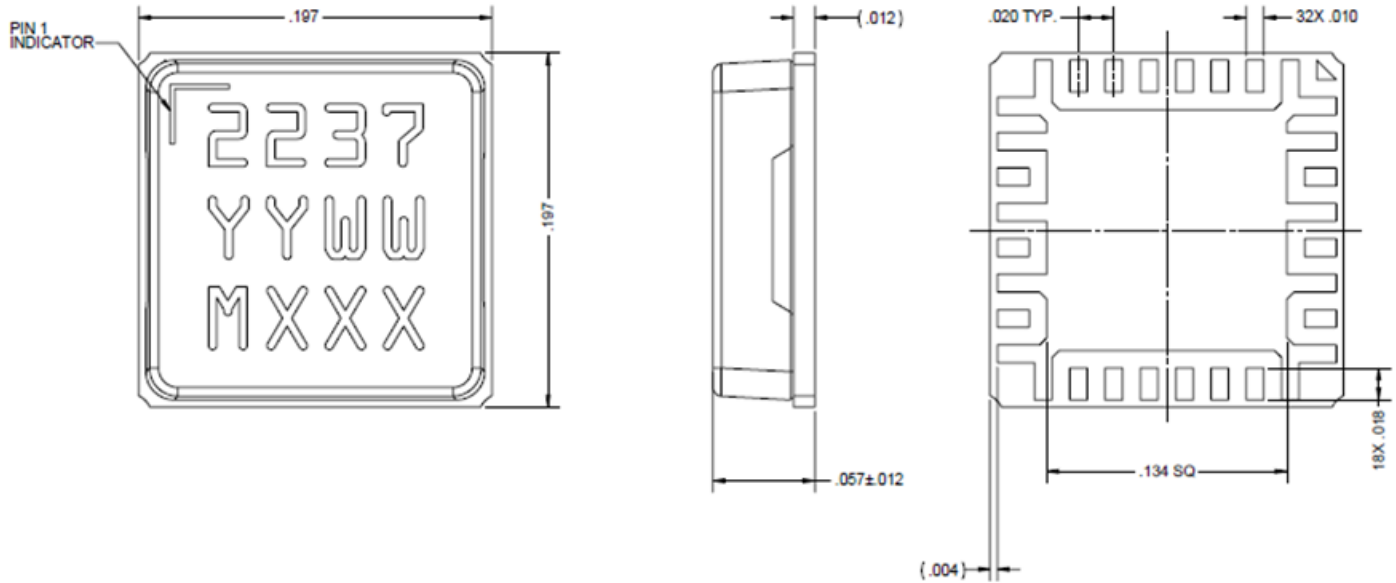

Units: inches  
 Tolerances: unless specified  
 x.xx = ± 0.01  
 x.xxx = ± 0.005  
 Materials:  
 Base: Ceramic  
 Lid: Plastic  
 All metalized features are gold plated  
 Part is epoxy sealed  
 Marking:  
 2237: Part number  
 YY: Part Assembly year  
 WW: Part Assembly week  
 MXXX: Batch ID

**Assembly Notes**

Compatible with lead-free soldering processes with 260°C peak reflow temperature.

This package is air-cavity and non-hermetic, and therefore cannot be subjected to aqueous washing. The use of no-clean solder to avoid washing after soldering is highly recommended.

Contact plating: Ni-Au.

Solder rework not recommended.

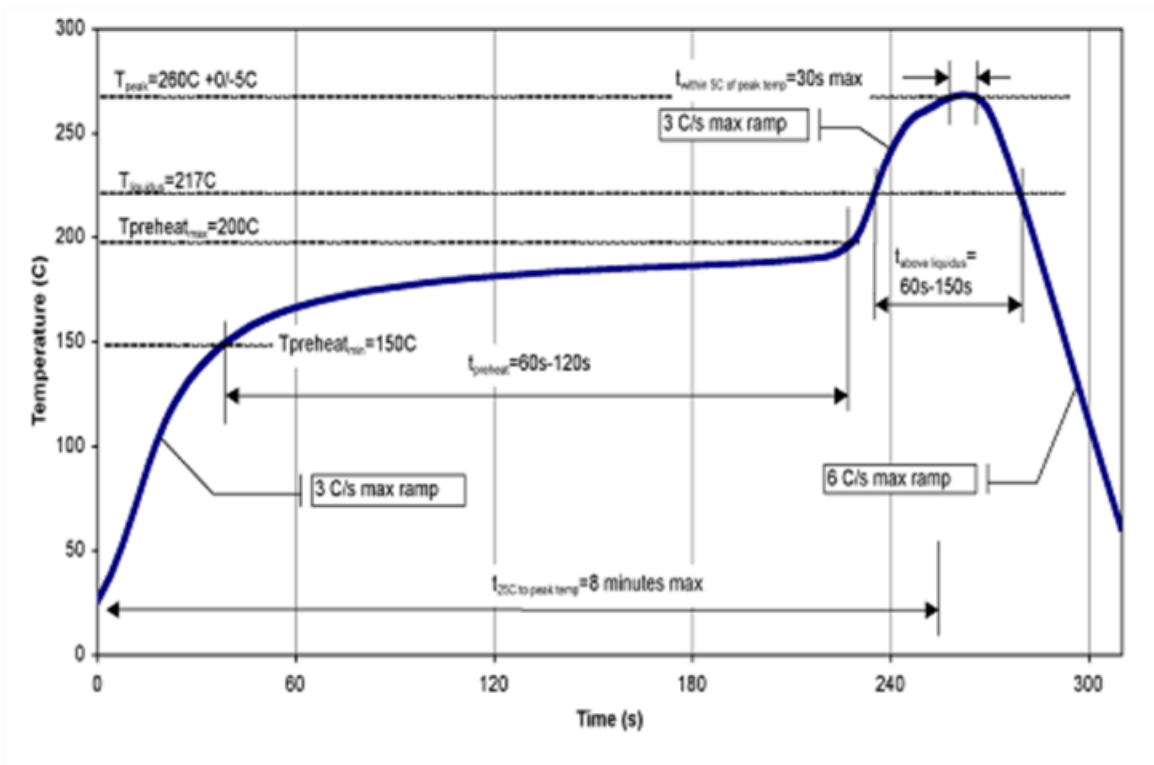

Recommended Soldering Temperature Profile

## Handling Precautions

Parameter	Rating	Standard
ESD – Human Body Model (HBM)	1C	ANSI/ESD/JEDEC JS-001
ESD – Charge Device Model (CDM)	C2	JESD22-C101
Moisture Sensitivity Level	MSL 3	J-STD-020, Level 3



Caution!

ESD-Sensitive Device

## RoHS Compliance

This part is compliant with 2011/65/EU RoHS directive (Restrictions on the Use of Certain Hazardous Substances in Electrical and Electronic Equipment) as amended by Directive 2015/863/EU.

This product also has the following attributes:

- Lead Free
- Halogen Free (Chlorine, Bromine)
- Antimony Free
- TBBP-A (C15H12Br4O2) Free
- PFOS Free
- SVHC Free

## Contact Information

For the latest specifications, additional product information, worldwide sales and distribution locations:

**Web:** [www.qorvo.com](http://www.qorvo.com)

**Tel:** 1-844-890-8163

**Email:** [customer.support@qorvo.com](mailto:customer.support@qorvo.com)

## Important Notice

The information contained herein is believed to be reliable; however, Qorvo makes no warranties regarding the information contained herein and assumes no responsibility or liability whatsoever for the use of the information contained herein. All information contained herein is subject to change without notice. Customers should obtain and verify the latest relevant information before placing orders for Qorvo products. The information contained herein or any use of such information does not grant, explicitly or implicitly, to any party any patent rights, licenses, or any other intellectual property rights, whether with regard to such information itself or anything described by such information. **THIS INFORMATION DOES NOT CONSTITUTE A WARRANTY WITH RESPECT TO THE PRODUCTS DESCRIBED HEREIN, AND QORVO HEREBY DISCLAIMS ANY AND ALL WARRANTIES WITH RESPECT TO SUCH PRODUCTS WHETHER EXPRESS OR IMPLIED BY LAW, COURSE OF DEALING, COURSE OF PERFORMANCE, USAGE OF TRADE OR OTHERWISE, INCLUDING THE IMPLIED WARRANTIES OF MERCHANTABILITY AND FITNESS FOR A PARTICULAR PURPOSE.**

Without limiting the generality of the foregoing, Qorvo products are not warranted or authorized for use as critical components in medical, life-saving, or life-sustaining applications, or other applications where a failure would reasonably be expected to cause severe personal injury or death.

© 2020 Qorvo US, Inc. All rights reserved. This document is subject to copyright laws in various jurisdictions worldwide and may not be reproduced or distributed, in whole or in part, without the express written consent of Qorvo US, Inc.