

# MITSUBISHI IGBT MODULES

## CM300DU-12H

HIGH POWER SWITCHING USE  
INSULATED TYPE

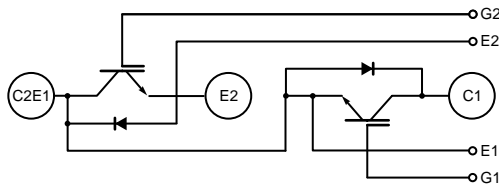
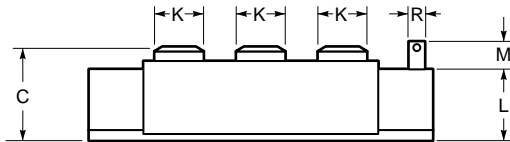
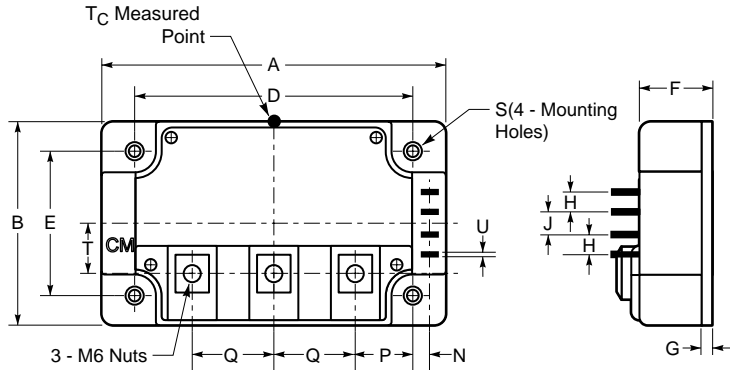

### Description:

Mitsubishi IGBT Modules are designed for use in switching applications. Each module consists of two IGBTs in a half-bridge configuration with each transistor having a reverse-connected super-fast recovery free-wheel diode. All components and interconnects are isolated from the heat sinking baseplate, offering simplified system assembly and thermal management.

### Features:

- Low Drive Power
- Low  $V_{CE(sat)}$
- Discrete Super-Fast Recovery Free-Wheel Diode
- High Frequency Operation
- Isolated Baseplate for Easy Heat Sinking

### Applications:

- AC Motor Control
- Motion/Servo Control
- UPS
- Welding Power Supplies

### Ordering Information:

Example: Select the complete module number you desire from the table - i.e. CM300DU-12H is a 600V ( $V_{CES}$ ), 300 Ampere Dual IGBT Module.

Type	Current Rating Amperes	$V_{CES}$ Volts (x 50)
CM	300	12

### Outline Drawing and Circuit Diagram

Dimensions	Inches	Millimeters
A	4.25	108.0
B	2.44	62.0
C	1.14 +0.04/-0.02	29 +1.0/-0.5
D	3.66±0.01	93.0±0.25
E	1.88±0.01	48.0±0.25
F	0.87	22.0
G	0.16	4.0
H	0.24	6.0
J	0.59	15.0

Dimensions	Inches	Millimeters
K	0.71	18.0
L	0.87	22.0
M	0.33	8.5
N	0.10	2.5
P	0.85	21.5
Q	0.98	25.0
R	0.11	2.8
S	0.25 Dia.	6.5 Dia.
T	0.6	15.15

## CM300DU-12H

HIGH POWER SWITCHING USE  
INSULATED TYPEAbsolute Maximum Ratings,  $T_j = 25\text{ }^\circ\text{C}$  unless otherwise specified

Ratings	Symbol	CM300DU-12H	Units
Junction Temperature	$T_j$	-40 to 150	$^\circ\text{C}$
Storage Temperature	$T_{stg}$	-40 to 125	$^\circ\text{C}$
Collector-Emitter Voltage (G-E SHORT)	$V_{CES}$	600	Volts
Gate-Emitter Voltage (C-E SHORT)	$V_{GES}$	$\pm 20$	Volts
Collector Current ( $T_c = 25^\circ\text{C}$ )	$I_C$	300	Amperes
Peak Collector Current ( $T_j \leq 150^\circ\text{C}$ )	$I_{CM}$	600*	Amperes
Emitter Current** ( $T_c = 25^\circ\text{C}$ )	$I_E$	300	Amperes
Peak Emitter Current**	$I_{EM}$	600*	Amperes
Maximum Collector Dissipation ( $T_c = 25^\circ\text{C}$ )	$P_C$	890	Watts
Mounting Torque, M6 Main Terminal	–	3.5–4.5	$\text{N} \cdot \text{m}$
Mounting Torque, M6 Mounting	–	3.5–4.5	$\text{N} \cdot \text{m}$
Weight	–	400	Grams
Isolation Voltage (Main Terminal to Baseplate, AC 1 min.)	$V_{iso}$	2500	$V_{rms}$

\* Pulse width and repetition rate should be such that the device junction temperature ( $T_j$ ) does not exceed  $T_{j(max)}$  rating.

\*\*Represents characteristics of the anti-parallel, emitter-to-collector free-wheel diode (FWDi).

Static Electrical Characteristics,  $T_j = 25\text{ }^\circ\text{C}$  unless otherwise specified

Characteristics	Symbol	Test Conditions	Min.	Typ.	Max.	Units
Collector-Cutoff Current	$I_{CES}$	$V_{CE} = V_{CES}, V_{GE} = 0V$	–	–	1	mA
Gate Leakage Voltage	$I_{GES}$	$V_{GE} = V_{GES}, V_{CE} = 0V$	–	–	0.5	$\mu\text{A}$
Gate-Emitter Threshold Voltage	$V_{GE(th)}$	$I_C = 30\text{mA}, V_{CE} = 10V$	4.5	6	7.5	Volts
Collector-Emitter Saturation Voltage	$V_{CE(sat)}$	$I_C = 300\text{A}, V_{GE} = 15V, T_j = 25^\circ\text{C}$	–	2.4	3.0	Volts
		$I_C = 300\text{A}, V_{GE} = 15V, T_j = 125^\circ\text{C}$	–	2.6	–	Volts
Total Gate Charge	$Q_G$	$V_{CC} = 300V, I_C = 300\text{A}, V_{GE} = 15V$	–	600	–	nC
Emitter-Collector Voltage*	$V_{EC}$	$I_E = 300\text{A}, V_{GE} = 0V$	–	–	2.6	Volts

\* Pulse width and repetition rate should be such that the device junction temperature ( $T_j$ ) does not exceed  $T_{j(max)}$  rating.Dynamic Electrical Characteristics,  $T_j = 25\text{ }^\circ\text{C}$  unless otherwise specified

Characteristics	Symbol	Test Conditions	Min.	Typ.	Max.	Units	
Input Capacitance	$C_{ies}$		–	–	26.4	nF	
Output Capacitance	$C_{oes}$	$V_{CE} = 10V, V_{GE} = 0V$	–	–	14.4	nF	
Reverse Transfer Capacitance	$C_{res}$		–	–	4	nF	
Resistive	Turn-on Delay Time	$t_{d(on)}$	$V_{CC} = 300V, I_C = 300\text{A},$	–	–	250	ns
	Rise Time	$t_r$	$V_{GE1} = V_{GE2} = 15V,$	–	–	600	ns
Switch	Turn-off Delay Time	$t_{d(off)}$	$R_G = 2.1\Omega, \text{Resistive}$	–	–	350	ns
	Fall Time	$t_f$	Load Switching Operation	–	–	300	ns
Diode Reverse Recovery Time	$t_{rr}$	$I_E = 300\text{A}, di_E/dt = -600\text{A}/\mu\text{s}$	–	–	160	ns	
Diode Reverse Recovery Charge	$Q_{rr}$	$I_E = 300\text{A}, di_E/dt = -600\text{A}/\mu\text{s}$	–	0.72	–	$\mu\text{C}$	

Thermal and Mechanical Characteristics,  $T_j = 25\text{ }^\circ\text{C}$  unless otherwise specified

Characteristics	Symbol	Test Conditions	Min.	Typ.	Max.	Units
Thermal Resistance, Junction to Case	$R_{th(j-c)Q}$	Per IGBT 1/2 Module	–	–	0.14	$^\circ\text{C}/\text{W}$
Thermal Resistance, Junction to Case	$R_{th(j-c)D}$	Per FWDi 1/2 Module	–	–	0.24	$^\circ\text{C}/\text{W}$
Contact Thermal Resistance	$R_{th(c-f)}$	Per Module, Thermal Grease Applied	–	0.020	–	$^\circ\text{C}/\text{W}$

# CM300DU-12H

HIGH POWER SWITCHING USE  
INSULATED TYPE

**OUTPUT CHARACTERISTICS (TYPICAL)**

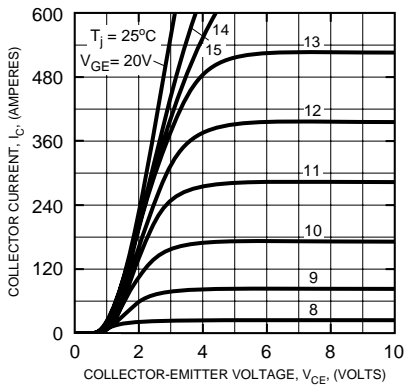

**TRANSFER CHARACTERISTICS (TYPICAL)**

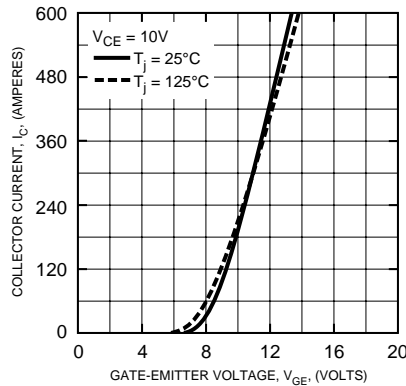

**COLLECTOR-EMITTER SATURATION VOLTAGE CHARACTERISTICS (TYPICAL)**

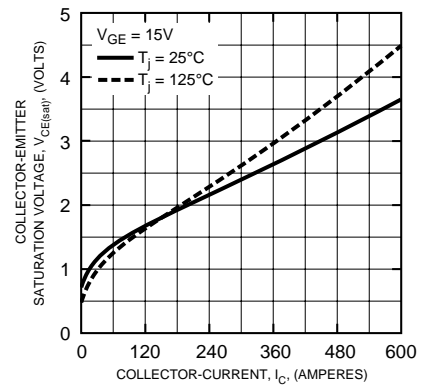

**COLLECTOR-EMITTER SATURATION VOLTAGE CHARACTERISTICS (TYPICAL)**

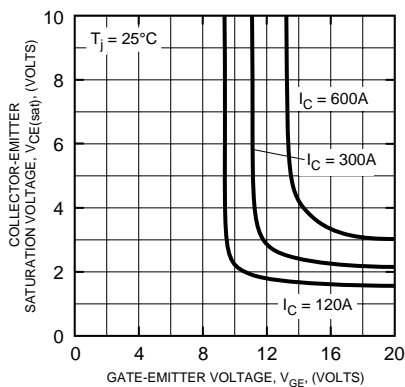

**FREE-WHEEL DIODE FORWARD CHARACTERISTICS (TYPICAL)**

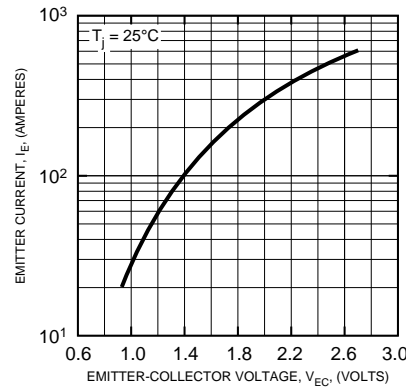

**CAPACITANCE VS.  $V_{CE}$  (TYPICAL)**

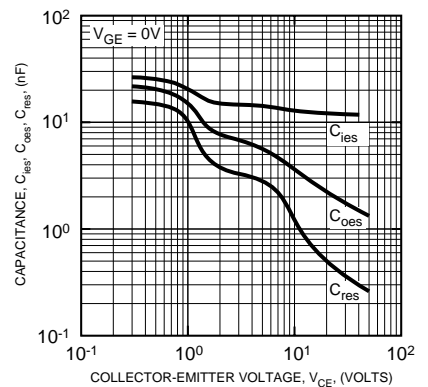

**HALF-BRIDGE SWITCHING CHARACTERISTICS (TYPICAL)**

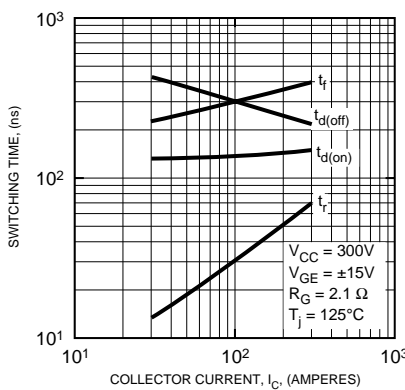

**REVERSE RECOVERY CHARACTERISTICS (TYPICAL)**

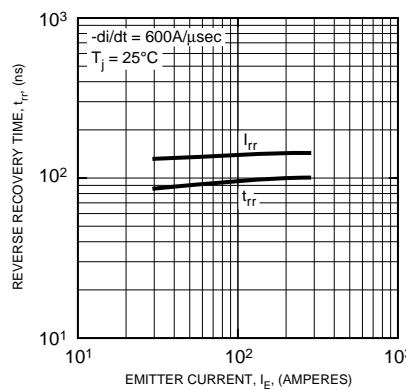

**GATE CHARGE,  $V_{GE}$**

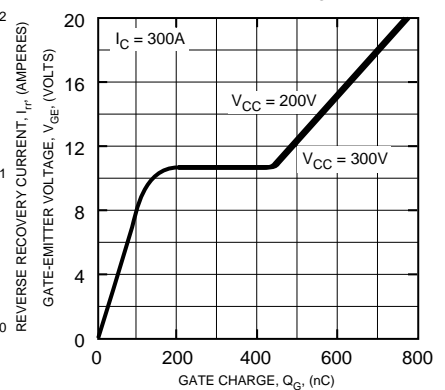

# CM300DU-12H

HIGH POWER SWITCHING USE  
INSULATED TYPE

