

DATE	REV	ECN	APP'D. BY
3-13-09	A0	-	-

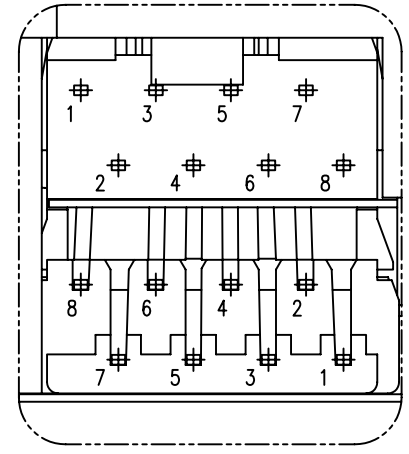

- NOTES:
- CONNECTOR MATERIALS:
HOUSING: THERMOPLASTIC UL94 V-0
CONTACTS/SHIELD: COPPER ALLOY
SHIELD PLATING: NICKEL
CONTACT PLATING: SELECTIVE GOLD IN CONTACT AREA
SEE CHART FOR PART NUMBER
 - FOR PRODUCT SPECIFICATIONS SEE PR022-01.
 - RATED AT MAX. 260°C FOR MAX. 10 SECS.
 - DIMENSIONS AND TOLERANCES COMPLY WITH FCC/CFR 47, PART 68.
 - THE SUGGESTED PANEL OPENING IS INTENDED TO GIVE USER THE ABILITY TO HAVE REASONABLE JACK/PANEL CLEARANCES, YET MAINTAIN GROUNDING CAPABILITY. THESE VARIABLES CAN BE ADJUSTED IN EITHER DIRECTION BUT MAY CARRY SOME CONSEQUENCES IN THE FORM OF LOWER MATING FORCES OR TIGHTER ASSEMBLY TOLERANCES.
 - DESIGNED FOR CATEGORY 5/5e APPLICATIONS.

50 MICRO-INCHES [1.27um]	SS73100-060F
CONTACT PLATING IN MATING AREA	PART NUMBER

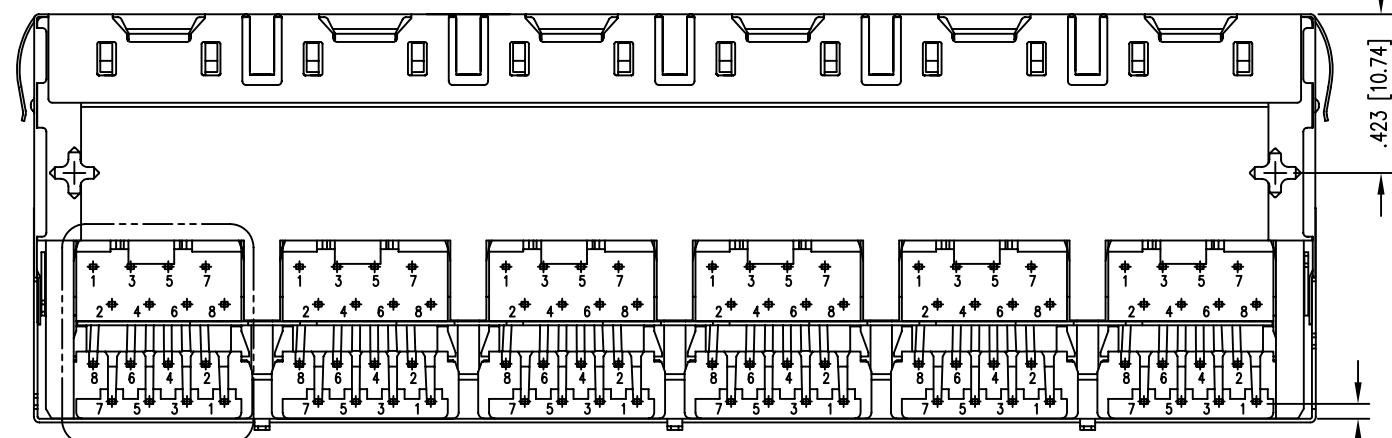
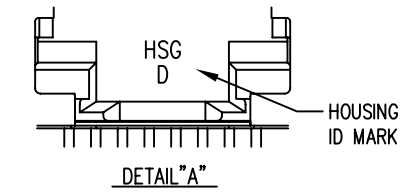
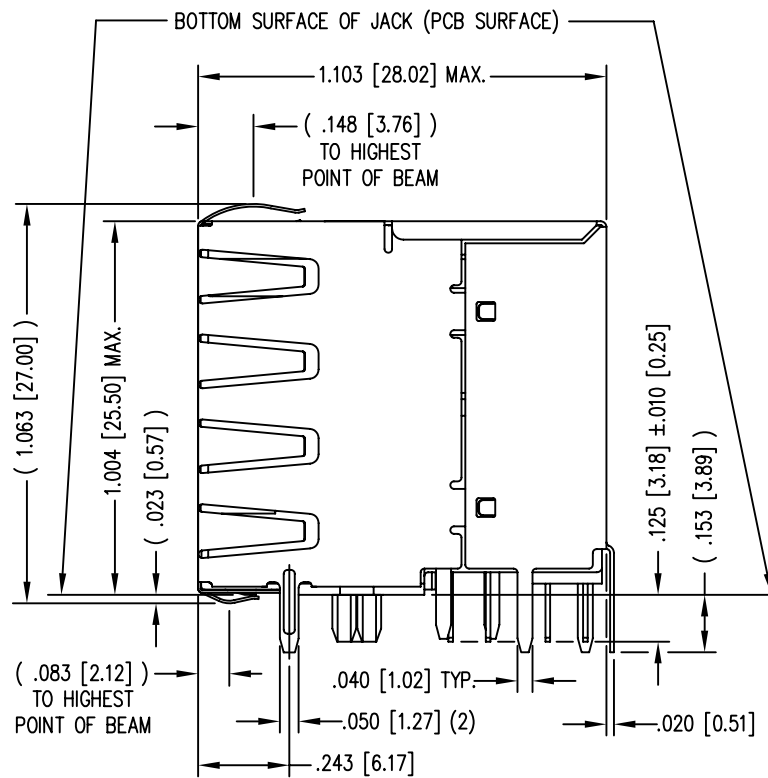
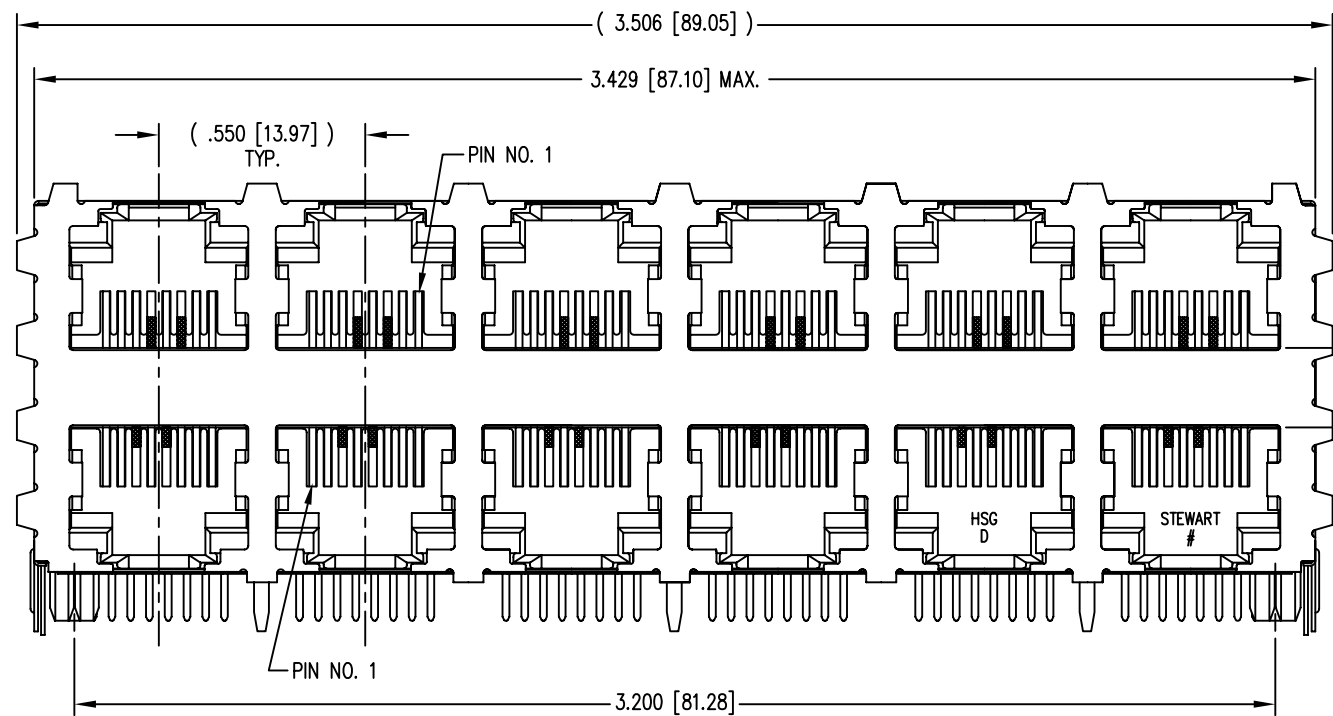
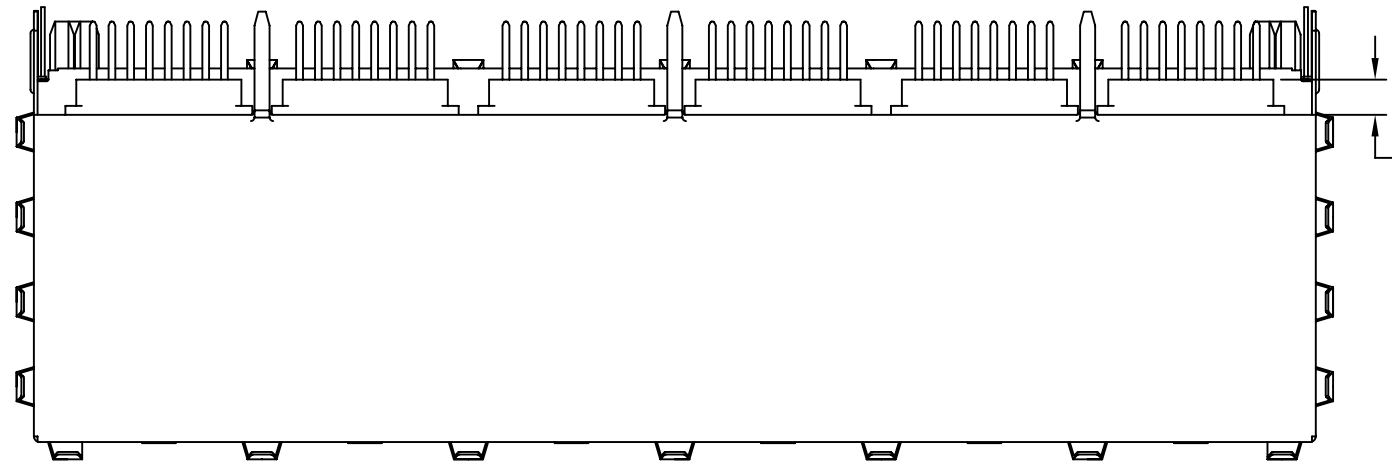

THIRD ANGLE PROJECTION

DO NOT SCALE DRAWING
DRAWING IS SUBJECT TO CHANGE WITHOUT NOTICE

DIMENSIONS: INCHES [METRIC]

UNLESS OTHERWISE SPECIFIED
TOLERANCES ARE ±.005 [0.13]
ANGLES ARE ± 1°

SHEET NO. 1 OF 2

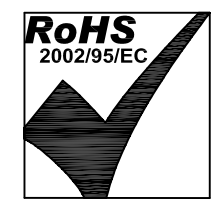

Bel Stewart Connector

11118 Susquehanna Trail South
Glen Rock, PA 17327-9199
(717) 235-7512 Fax: (717) 235-7954 <http://www.stewartconnector.com>

TITLE: HIGH PERFORMANCE SHIELDED STACK JACK, 12 PORTS (6 ON 6) EIGHT CONTACT, EIGHT POSITION, 50 MICRO INCHES GOLD

THIS DRAWING AND THE SUBJECT MATTER SHOWN THEREON ARE CONFIDENTIAL AND THE PROPRIETARY PROPERTY OF BEL STEWART CONNECTOR AND SHALL NOT BE REPRODUCED, COPIED, OR USED IN ANY MANNER WITHOUT PRIOR WRITTEN CONSENT OF BEL STEWART CONNECTOR. THE SUBJECT MATTER MAY BE PATENTED OR A PATENT MAY BE PENDING.

DRN BY:	TRM	DATE	3-13-09
APPD BY:	DHG	DATE	3-16-09
DWG NO.	CT730163F	REV.	A0

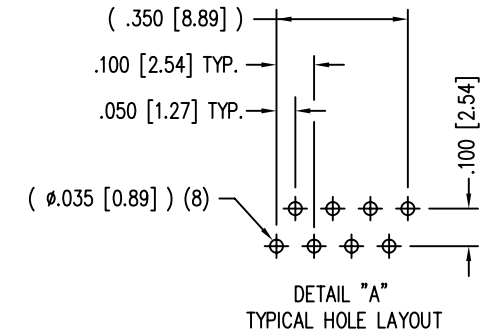
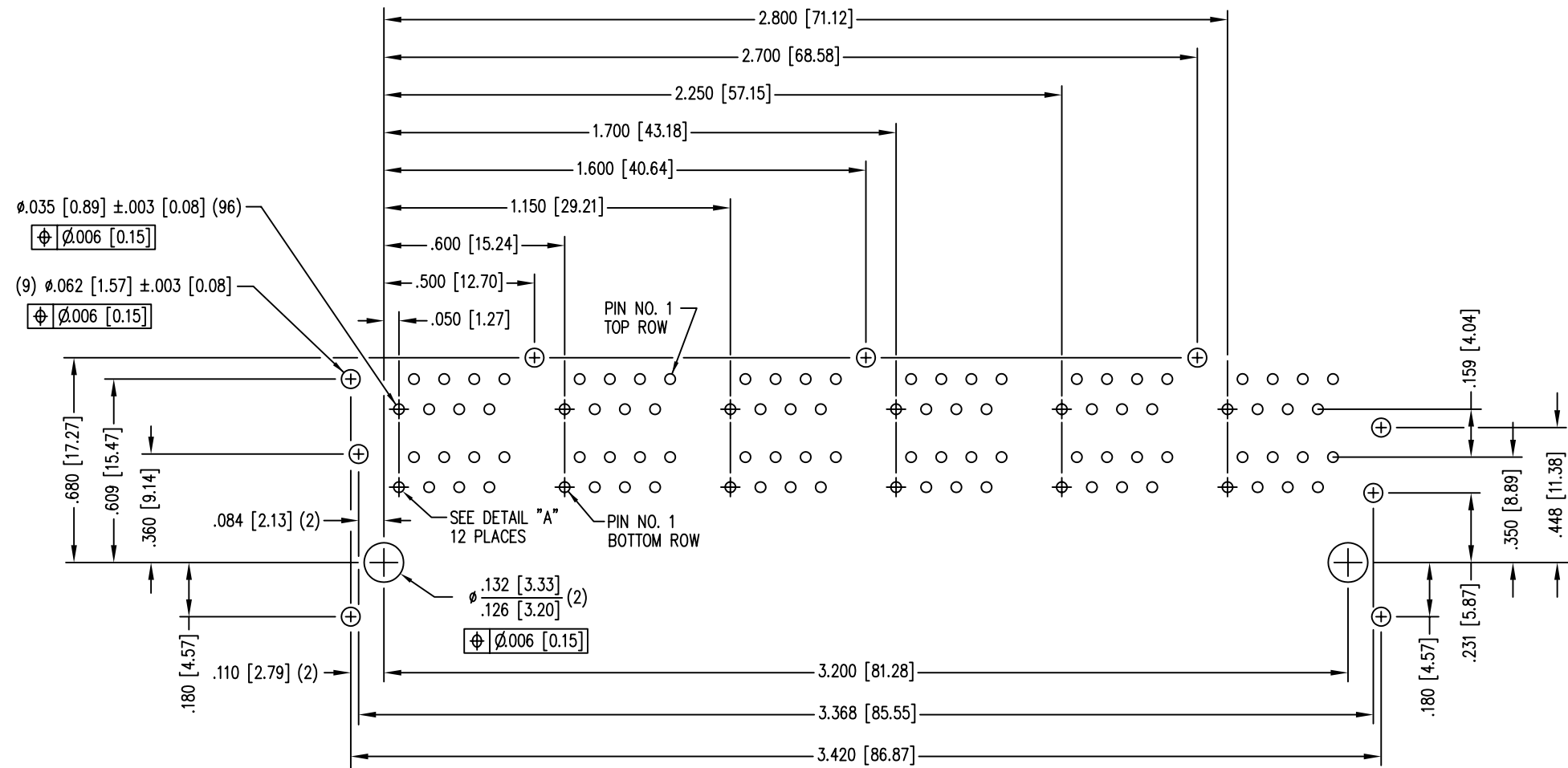

P.C.B. RECOMMENDED HOLE LAYOUT
SEEN FROM COMPONENT SIDE

ALL CENTERLINE DIMENSIONS ARE BASIC.

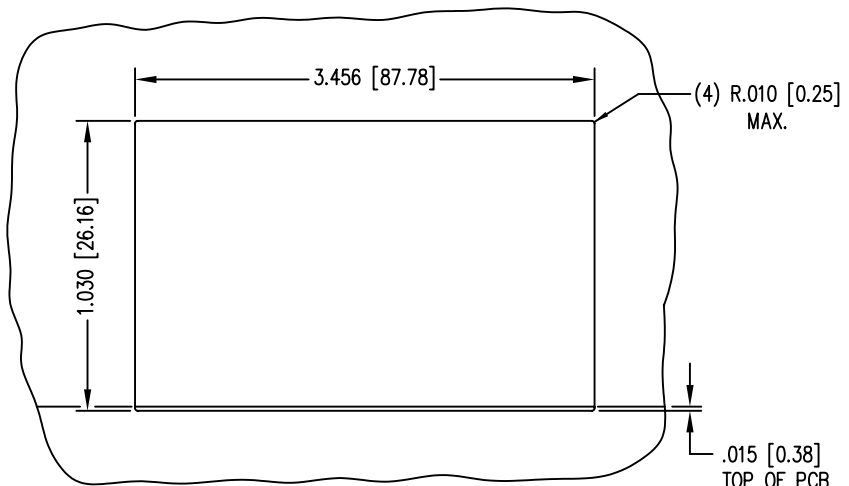

SUGGESTED PANEL OPENING
N.T.S.

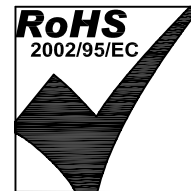
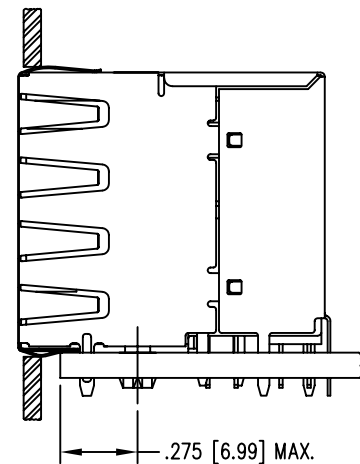

THIRD ANGLE PROJECTION

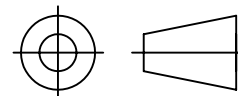

DO NOT SCALE DRAWING
DRAWING IS SUBJECT TO
CHANGE WITHOUT NOTICE

DIMENSIONS: INCHES [METRIC]

UNLESS OTHERWISE SPECIFIED
TOLERANCES ARE \pm .005 [0.13]
ANGLES ARE \pm 1°

SHEET NO. 2 OF 2

Bel Stewart Connector

11118 Susquehanna Trail South
Glen Rock, PA 17327-9199
(717) 235-7512 Fax: (717) 235-7954 <http://www.stewartconnector.com>

TITLE: HIGH PERFORMANCE SHIELDED STACK JACK, 12 PORTS (6 ON 6)
EIGHT CONTACT, EIGHT POSITION, 50 MICRO INCHES GOLD

THIS DRAWING AND THE SUBJECT MATTER SHOWN THEREON
ARE CONFIDENTIAL AND THE PROPRIETARY PROPERTY OF
BEL STEWART CONNECTOR AND SHALL NOT BE REPRODUCED,
COPIED, OR USED IN ANY MANNER WITHOUT PRIOR WRITTEN
CONSENT OF BEL STEWART CONNECTOR. THE SUBJECT
MATTER MAY BE PATENTED OR A PATENT MAY BE PENDING.

DRN BY:	TRM	DATE	3-13-09
APPD BY:	DHG	DATE	3-16-09
DWG NO.	CT730163F	REV.	A0