



TO-92 Plastic-Encapsulate Transistors

A92 TRANSISTOR (PNP)

FEATURES

- High voltage

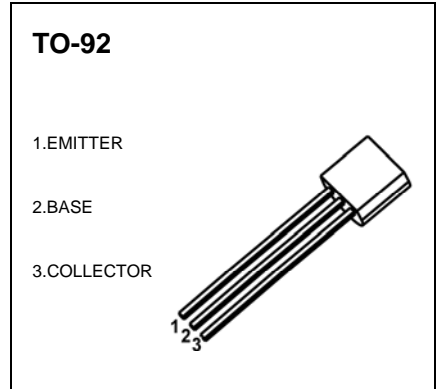

MARKING

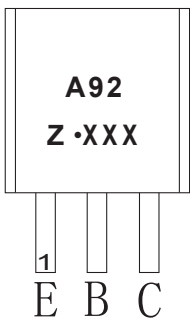

A92=Device code
 Solid dot=Green molding compound device,
 if none,the normal device
 Z=Rank of h_{FE}
 XXX=Code

Equivalent Circuit

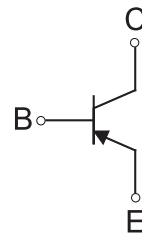

ORDERING INFORMATION

Part Number	Package	Packing Method	Pack Quantity
A92	TO-92	Bulk	1000pcs/Bag
A92-TA	TO-92	Tape	2000pcs/Box

MAXIMUM RATINGS ($T_a=25^{\circ}\text{C}$ unless otherwise noted)

Symbol	Parameter	Value	Units
V_{CBO}	Collector-Base Voltage	-310	V
V_{CEO}	Collector-Emitter Voltage	-305	V
V_{EBO}	Emitter-Base Voltage	-5	V
I_C	Collector Current -Continuous	-200	mA
I_{CM}	Collector Current - Pulsed	-500	mA
P_C	Collector Power Dissipation	625	mW
T_J, T_{stg}	Operation Junction and Storage Temperature Range	-55~150	$^{\circ}\text{C}$
$R_{\theta JA}$	Thermal Resistance, Junction to Ambient	200	$^{\circ}\text{C}/\text{mW}$
$R_{\theta JC}$	Thermal Resistance, Junction to Case	83.3	$^{\circ}\text{C}/\text{mW}$

ELECTRICAL CHARACTERISTICS

$T_a=25^\circ\text{C}$ unless otherwise specified

Parameter	Symbol	Test conditions	Min	Typ	Max	Unit
Collector-base breakdown voltage	$V_{(BR)CBO}$	$I_C=-100\mu\text{A}, I_E=0$	-310			V
Collector-emitter breakdown voltage	$V_{(BR)CEO}$	$I_C=-1\text{mA}, I_B=0$	-305			V
Emitter-base breakdown voltage	$V_{(BR)EBO}$	$I_E=-100\mu\text{A}, I_C=0$	-5			V
Collector cut-off current	I_{CBO}	$V_{CB}=-200\text{V}, I_E=0$			-0.25	μA
Emitter cut-off current	I_{EBO}	$V_{EB}=-5\text{V}, I_C=0$			-0.1	μA
DC current gain	$h_{FE(1)}$	$V_{CE}=-10\text{V}, I_C=-1\text{mA}$	60			
	$h_{FE(2)}$	$V_{CE}=-10\text{V}, I_C=-10\text{mA}$	80		250	
	$h_{FE(3)}$	$V_{CE}=-10\text{V}, I_C=-80\text{mA}$	60			
Collector-emitter saturation voltage	$V_{CE(sat)}$	$I_C=-20\text{mA}, I_B=-2\text{mA}$			-0.2	V
Base-emitter saturation voltage	$V_{BE(sat)}$	$I_C=-20\text{mA}, I_B=-2\text{mA}$			-0.9	V
Transition frequency	f_T	$V_{CE}=-20\text{V}, I_C=-10\text{mA}$ $f=30\text{MHz}$	50			MHz

CLASSIFICATION OF $h_{FE(2)}$

Rank	A	B	C
Range	80-100	100-200	200-250

Typical Characteristics

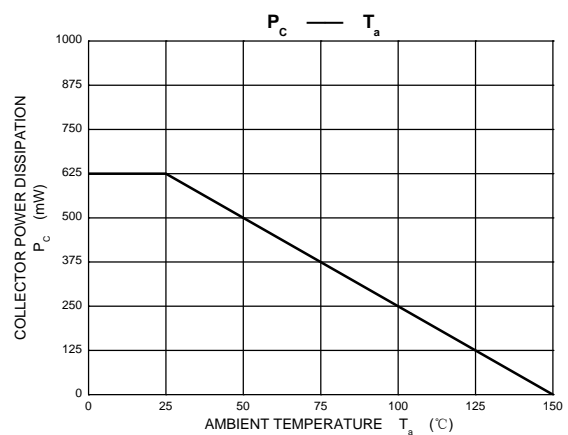
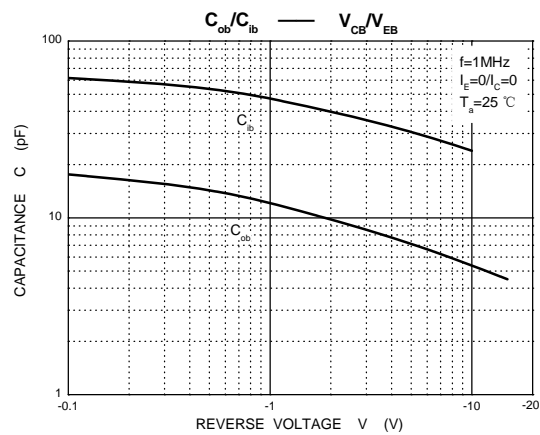
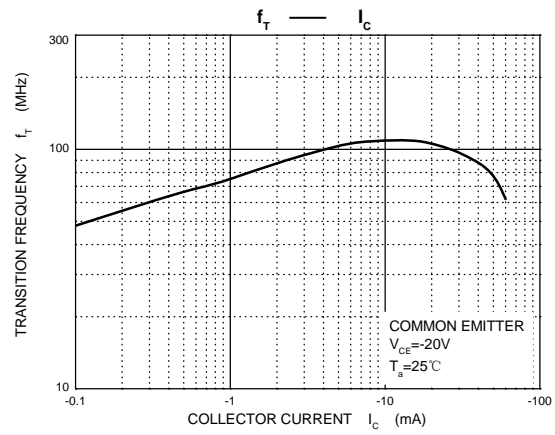
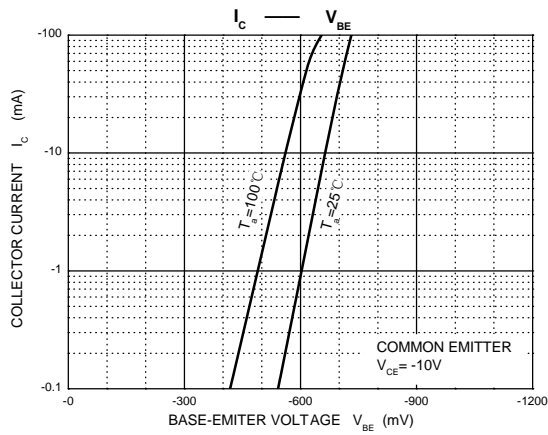
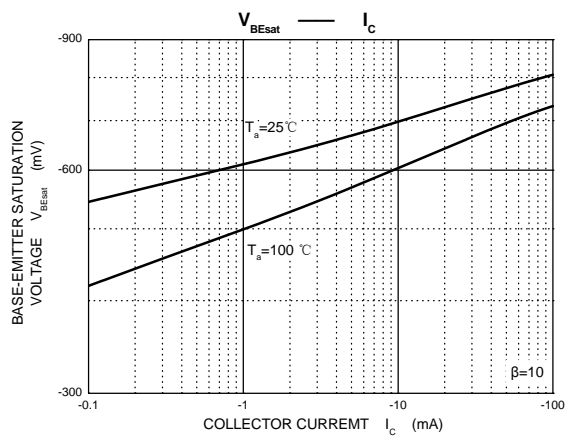
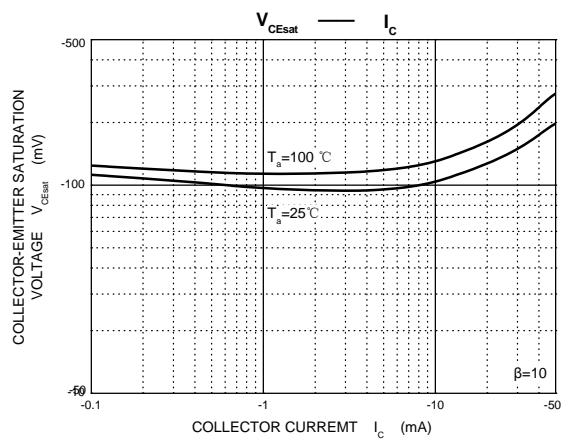
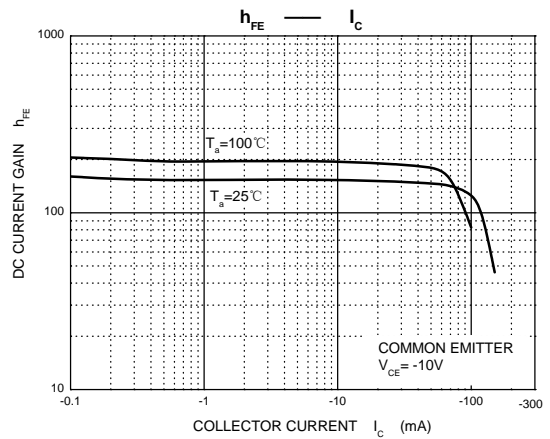
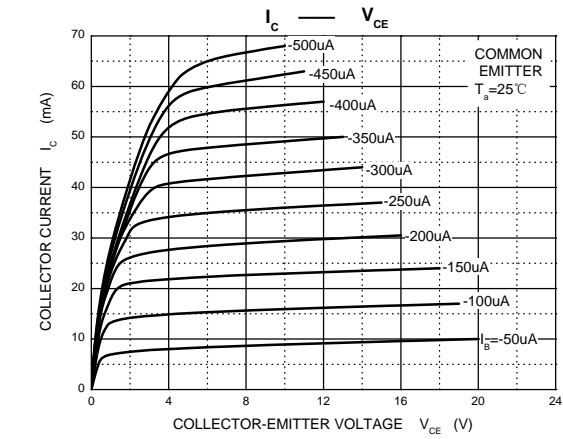

TO-92 Package Outline Dimensions



Symbol	Dimensions In Millimeters		Dimensions In Inches	
	Min	Max	Min	Max
A	3.300	3.700	0.130	0.146
A1	1.100	1.400	0.043	0.055
b	0.380	0.550	0.015	0.022
c	0.360	0.510	0.014	0.020
D	4.300	4.700	0.169	0.185
D1	3.430		0.135	
E	4.300	4.700	0.169	0.185
e	1.270 TYP		0.050 TYP	
e1	2.440	2.640	0.096	0.104
L	14.100	14.500	0.555	0.571
Φ		1.600		0.063
h	0.000	0.380	0.000	0.015

TO-92 Suggested Pad Layout



Note:

1. Controlling dimension: in millimeters.
2. General tolerance: $\pm 0.05\text{mm}$.
3. The pad layout is for reference purposes only.

NOTICE

JSCJ reserves the right to make modifications, enhancements, improvements, corrections or other changes without further notice to any product herein. JSCJ does not assume any liability arising out of the application or use of any product described herein.

TO-92 PACKAGE TAPING DIMENSION



Dimensions are in millimeter								
A1	A	T	P	P0	P2	F1	F2	W
4.5	4.5	3.5	12.7	12.7	6.35	2.5	2.5	18.0
W0	W1	W2	H	H0	D0	t1	t2	ΔP
6.0	9.0	1.0 MAX.	19.0	16.0	4.0	0.4	0.2	0

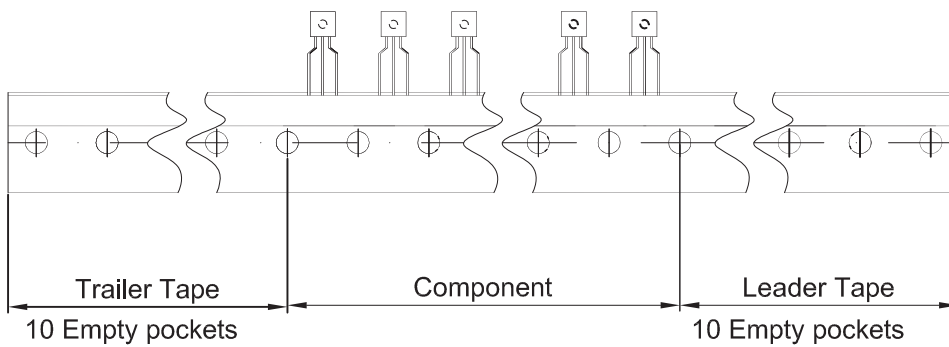

Package	Box	Box Size(mm)	Carton	Carton Size(mm)
TO-92	2000 pcs	333×162×43	20,000 pcs	350×340×250